

Golden Age
of the
Moor

Edited by
Juan Van Sertima

LEICESTER CITY LIBRARIES	
1560005815 1130	
Wolb Nelson	7-11-99
909-0496	F16-95
nlf	

Second printing 1993.

Copyright © 1992 by Journal of African Civilizations Ltd., Inc.

All rights reserved under International and Pan-American Copyright Conventions. No part of this book may be reproduced or transmitted in any form or by any means, electronic or mechanical, including photocopy, recording, or any information storage and retrieval system, without prior permission in writing from the publisher.

ISSN: 0270-2495

ISBN: 1-56000-581-5

Printed in the United States of America

Cover design by Jacqueline L. Patten-Van Sertima

JOURNAL OF
AFRICAN CIVILIZATIONS

VOL. 11

FALL, 1991

GOLDEN AGE OF THE MOOR

Contents

RACE AND ORIGIN OF THE MOORS

- | | |
|---|----|
| 1.(a) The Moor in Africa and Europe:
Origins and Definitions
Ivan Van Sertima | 1 |
| 1.(b) The Moor in Europe:
Influences and Contributions
Ivan Van Sertima | 9 |
| 2.(a) The Moors in Antiquity
James E. Brunson and Runoko Rashidi | 27 |
| 2.(b) The Empire of the Moors
(An outline; based on interview and summary)
John G. Jackson | 85 |
| 3. The African Heritage & Ethnohistory of the Moors:
Background to the emergence of early Berber and Arab
peoples, from prehistory to the Islamic Dynasties
Dana Reynolds | 93 |

MOORISH CONTRIBUTIONS TO EUROPEAN CIVILIZATION

- | | |
|--|-----|
| 4. The Moor: Light of Europe's Dark Age
Wayne Chandler | 151 |
| 5. Moorish Spain: Academic Source and Foundation for
the Rise and Success of Western European Universities
in the Middle Ages
José V. Pimienta-Bey | 182 |
| 6. Moorish Culture-Bringers:
Bearers of Enlightenment
Jan Carew | 248 |
| 7. The Music of the Moors in Spain
(Al-Andalus, 711-1492 A.D.)
Origin of Andalusian Musical Art:
Its Development and Influence on Western Culture
Yusef Ali | 278 |

8.	The Moors and Portugal's Global Expansion Edward Scobie	331
9.	Africans in the Birth and Expansion of Islam Mamadou Chinyelu	360
<i>THE SCIENCE OF THE MOORS</i>		
10.	Cairo: Science Academy of the Middle Ages Beatrice Lumpkin and Siham Zitler	382
11.	The Egyptian Precursor to Greek and "Arab" Science	
	(a) The Judgement	396
	(b) Supplements to the Indictment	405
	Ivan Van Sertima	
12.	An Annotated Bibliography of the Moors: 711-1492 A.D. James Ravell	407
	Biographical Notes on Contributors	455



African General Boabdil (Abu-Abdi-Llah) surrenders to the Spanish (Granada, 1492).

THE MOOR IN AFRICA AND EUROPE

Ivan Van Sertima

1. Origins and Definitions

It is generally assumed that the movement of Africans into Europe, in significantly large numbers and into positions of real power, did not occur until the Muslim invasion of Spain in 711 A.D. In Al-Makkary's *History of the Mohammedan Dynasties in Spain*, however, we learn of a great drought that afflicted Spain about three thousand years ago, a catastrophe that was followed not long afterwards by an invasion from Africa. This, of course, had nothing to do with the medieval Moors, with which this book is primarily concerned, but it is worth noting here because it actually established an ancient African dynasty in Spain, a fact that is omitted from the official histories.

The drought that devastated Spain, however, is described by a number of Spanish historians. Pedro de Medina in *Libro de las Grandezas de Espana*, published in Seville in 1549, dates the drought at 1070 B.C. Ibn-l-Khattib Al-Makkary (in his major historical work, translated by Pascual de Gayangos¹) describes it in some detail. It is Al-Makkary also who informs us of how Africans banished from North Africa by an African king against whom they revolted, entered Spain and took control of that country. The leader of the Africans is recorded as Batrikus. What his original name was we do not know but it survives as Batrikus in the Latin of the Romans because it was the Romans who defeated these Africans 157 years later.

These Africans first cast anchor at a place on the western shore of Spain and settled at Cadiz. Advancing into the interior of the country, they spread themselves about, extended their settlements, built cities and towns and increased their numbers by marriage. They settled in that part of the country between the place of their landing in the west, and the country of the Franks in the east, and appointed kings to rule over them and administer their affairs. They fixed their capital at Talikah (Italica) a city now in ruins, which once belonged to the district of Isbilah, which is the modern Seville. But, after a period of one hundred and fifty seven years, during which eleven kings of the African race reigned over Andalus they were annihilated by the Romans, who invaded and conquered the country.²

The second major intrusion of an African army into Spain before the Moors, occurs sometime around 700 B.C. during the period of the 25th dynasty in Egypt, when the Ethiopian Taharka was a young general, but before he had been ceded the throne by his uncle Shabataka.

It is this same Taharka (referred to in early Spanish chronicles as Tarraco) that led a garrison into Spain and invaded it during this period. We have a clear and indisputable reference to this in a manuscript by Florian de Ocampo *Cronica General* published in Medina del Campo in 1553.³ The name of the invading general is given as Tarraco. He is not only identified as head of the Ethiopian army. The reference is more specific. It says he was later to become a King of Egypt. The name, the period, the historical fact of his generalship and his later kingship of Egypt, his Ethiopian origin and the wide-ranging trade and exploration of the Ethiopian in this period, all attest to the validity of this reference. But most persuasive of all is the fact that cartouches of the Upper Egyptian kings of this period have been found in Spain. Evidence of such cartouches may be found in the *Journal of the Epigraphic Society* (Vol 7, No. 171–April 1979).⁴ The cartouche* of Shishonq, a Libyan king, was found in Tomb 16, Almunecar, Spain. The Libyans ruled with the support of Nubian armies from the 22nd to the 24th dynasties and were overthrown by the Nubians in the 25th. [see plate 1]

The fact that Africans from the North had been intruding into Southern Europe from very early times should not come as a great surprise, for the straits that separate the two continents can be crossed by the simplest boats in a matter of hours. The proximity of the borders of Europe and Africa and the evidence of the African phenotype among many southern Europeans led Napoleon to remark that “Africa begins at the Pyrenees.” Many historians, however, make clear-cut distinctions between the early North Africans and the Africans of the Sahara. They contend that the Africans who made contact and left their mark on Europe should not be confused with the sub-Saharan African type. They see these people as Euro-Africans (another version of the “brown Mediterranean race” myth used to account for the genius of ancient Egypt). Since many North Africans in modern times seem to fit into this theoretical construct it has worked very well to confuse and confound the definition of their ethnicity. Some of our contributors, although well grounded in their particular areas of expertise, are vague about the origins of the North African tribes and the complex of historical factors that have transformed the cultural and physical configuration of these people. This has compelled me to use my editorial mandate and overview to bring what I hope is a more decisive clarity to this matter.

The people whom the classical Greek and Roman authors called Berber were mainly Black and affiliated with the then contemporary peoples of the East African area. The word Berber was used in fact to refer to peoples of the Red Sea area in Africa as well as North Africans. It was an ancient belief that the nomads dwelling in the deserts of Arabia were the same peoples whose ancestors had in earlier times roamed the deserts of East Africa. It was such

*A cartouche is an ornamental carving or scroll depicting characters that represent the name of a sovereign.

A Cartouche of Shishonq from Almunecar, Southern Spain Barry Fell

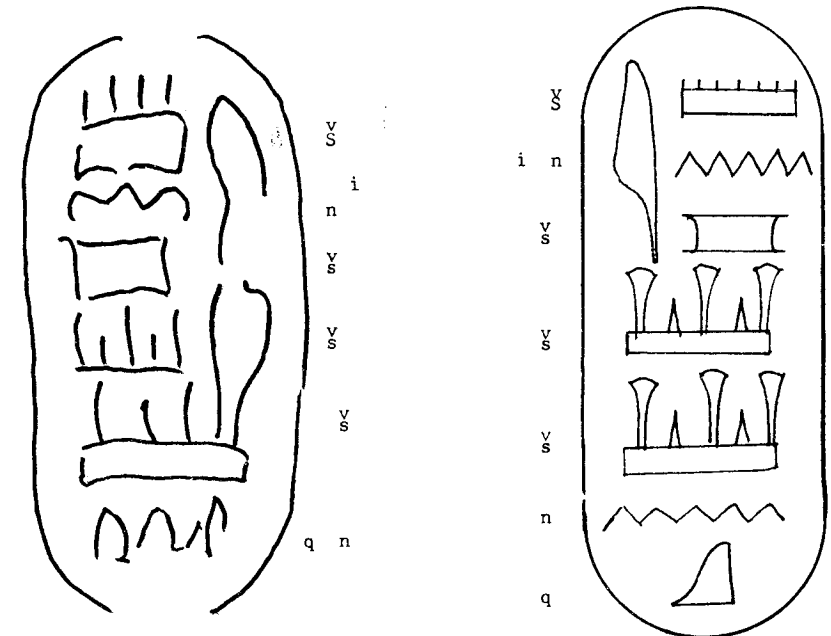

To left, actual cartouche as engraved on an alabaster trade vase found in Tomb 16, Almunecar (courtesy Instituto Arqueologico Aleman de Madrid). To right, same cartouche as rendered in the British Museum style. This, and other similar examples, show how carelessly even royal names may be rendered by ancient scribes.

Evidence of contact between Spain and Upper Egypt in the First Millennium B.C.

Courtesy of the *Journal of the Epigraphic Society*

Figure 1

populations that largely comprised the Moorish people, called Moors (from the Greek *maures*, the Roman *maurus* = dark) because of the attribute of blackness which sharply distinguished them from the bulk of the European people.

However, the inhabitants of present-day North Africa are considered ethnically and culturally distinct from people dwelling south of the Sahara. This is only so today because of the considerable influx of European types during the white slave trade and their later movement in positions of dominance after the defeat of the Moors.

The seven hundred years during which the Moors dominated the Iberian peninsula was an era in which many Europeans came into North Africa in states of servitude. The Muslims brought millions of European slaves over to the North African ports of Sale, Tangier, Algiers, Tunis, Tripoli, Fez and Marrakesh and some of the northern Egyptian towns. One very famous Sultan, Mulai Ismail of Meknes, in Morocco, had as many as 25,000 European slaves who participated in the building of his colossal stables.⁵ Sudanese were also taken into slavery but before the fifteenth century not as many as the whites. It was these Europeans who began to modify through intermixture the earlier black inhabitants of North Africa. This is what eventually made so many North Africans appear different from the sub-Saharan Africans.

The anthropologist, Dana Reynolds, in an exhaustive and meticulously detailed essay, has attempted to trace the African roots of the original North African peoples. She cites half a dozen Greek and Byzantine (neo-Roman writers) from the first to the sixth century AD, who describe the Berber population of North Africa as black-skinned. Among these writers are Martial, Silius Italicus, Corippus and Procopius.

The original Black Berbers, who were called Moors, were the North African ancestors of the present day dark-brown and brown-black peoples of the Sahara and the Sahel, mainly those called Fulani, Tuareg, Zenagha of Southern Morocco, Kunta and Tebbu of the Sahel countries as well as other black Arabs now living in Mauretania and throughout the Sahel. They include the Trarza of Mauretania and Senegal, the Mogharba as well as dozens of other Sudanese tribes, the Chaamba of Chad and Algeria.

Apart from her very detailed study of the origins and affiliations of the various tribes, she points out that the Africans involved in the Moorish occupation of Iberia did not just build remarkable things in Europe but also in their native lands. They founded and constructed many industrious and prosperous towns all over the north of Africa and as far south as Timbuctoo. The ruins of their many castles can be seen as much in Northern Africa as in Andalusia.

The evidence Reynolds presents to establish the Africoid base of the Berbers is challenged by Wayne Chandler who insists that the Berbers were already heavily mixed with a caucasoid element before the Moorish invasion.

They were classified as the “tawny Moors” and are to be distinguished, says he, from the “Blackamoors.” They are the result of a mixing of black Africans (the Garamantes of the Sahara) with a race of white Libyans. This clash of views has led to a stimulating debate. Let me state the case as presented by both contestants.

At the heart of the history of the ancient Moors, says Chandler, are the Garamantes of the Sahara. The Garamantes were black Africans who occupied much of northern Africa. They can be considered the ancestors of the true Moors. Contemporary with the Garamantes were the Libyans. Originally, claims Chandler, these Libyans (whom Menes attacked and defeated in the first dynasty) were Caucasians. They were called by their black conquerors “tamahu.” In Egyptian *tama* means people and *hu* is white or light ivory. Thus they were the white or light-skinned people. Portraits of the battle between Menes and these people indicate, according to Chandler, that they were a different race from the ancient dark-skinned Egyptian. These light-skinned people intermarried with the many blacks on all sides of them he claims, and became the “tawny Moors” or “white Moors”, also known as Berber from the Roman *barbari*—barbarian. The Arabs adopted this Roman term for them and changed it to Berber. Eventually the word Libyan and Berber became synonymous in some places.

The Sahara, he contends, came to be occupied by two distinct groups—the original Moors (Garamantes) and the Berbers, who later became the “tawny” or “white” Moors. The rest of North Africa, from Egypt through the Fezzan and the west of the Sahara to what is now called Morocco and Algeria, were peopled by black Africans, also called Moors by the Romans and the later Europeans. Eventually these Moors would join with “Arabs” to become a united and powerful force.

“Names like *Tamahu*,” Dana Reynolds points out, in a lengthy correspondence with me, “while originally used for indigenous Libyans, came to be used for the foreign colonists and mercenaries. For the Egyptian artist such names apparently possessed only geographical or national significance rather than ethnic or “racial” meaning. The earliest portrayals of Tamahou, however, rule out the idea that the word meant “ivory” or “white-skinned” people (as Chandler claims). A similar claim had been made for the earlier Libyan name *Tehehou* but as O. Bates and more recently Vichcyl point out, both of these names were first applied to men portrayed in Egyptian iconography with dark-brown skins and they were obviously of a different race and culture than the later blond invaders.

“F. Behrens, A. Arkell and several other specialists in the archaeology of Nubia and the south eastern Sahara have come to see the C-group culture as the population which was first designated Tamahou in the 6th dynasty. They were a relatively tall, slender, and obviously black population of pastoral nomads who came to settle in Nubia. The tombs they used belonged to the

Berber kind found all over ancient North Africa ... this type of man was, judging from the skeletal evidence and eyewitness accounts of early European historians, the predominant population of North Africa even at the time of the first Arab penetration into North Africa.” (See Chandler’s response in Appendix to this editorial.)

In his discussion of Berber ethnic origins, José Pimenta-Bey cites the views of Chiekh Anta Diop. On the matter of the Moors and the Berbers, however, Diop is not particularly helpful. It is refreshing that Bey sees this very clearly and qualifies his support. Although he cites the master with respect he does not follow him. Diop makes the unsupportable claim that the Berbers were post-Islamic invaders. His uncharacteristically uninformed commentary on the Moors led me to delete that section of his otherwise remarkable paper, which it was my honor to read at the Nile Valley Conference held in Atlanta in 1984.⁶

On the poor state of mathematics and astronomy in Europe at the time of the invasion, Diop was his usually perceptive self but he must have mixed up time-levels in a hurried look at the Berber. Sources on the Moors also seemed to be rather sparse in French. It is possible that General Martel’s defeat of the Moors and their virtual expulsion from France may account for this.

Professor Lotfi of Morocco University, whom Bey also cites, in no way “proves the contention that the Berber and the Moor are synonymous terms.” They probably were, but it is certainly not established by any of Lotfi’s arguments, which indicate an Africoid element but considerable ethnic diversity among the Berbers. Such contradictions can only be resolved by concentration on specific time-levels and an ability to demonstrate conclusively how this web of ethnic threads sprang from a single node. Only Reynolds offers this type of concentrated argument and documentation.* Bey, however, provides the most wide-ranging and well-researched thesis done so far to establish the great debt Europe owes to Moorish scholarship.

The essay of Runoko Rashidi and James Brunson provides us with one of the most comprehensive examinations of the use of the word Moor but they concede that it is still difficult to arrive at the precise ethnicity of a Moor through mere terminology alone. The fact that the term was originally intended to refer to a black or dark-skinned person, as they have shown, does not mean that everyone called a Moor is African or of African descent. The Arabs, themselves, rarely used the term Moor. They often used the term Berber for the non-Arabian people of Northwest Africa with whom they came in contact and who joined with them in the invasion of Europe. The early Christians also used the term “Saracen” indiscriminately to cover both “Moors” as well as other Muslim populations in general. Readers of the recent popular

**Editor’s Note:* Lay-readers are advised to concentrate on the introduction and conclusions to Reynolds’ essay, since the bulk of it is presented in a style intended primarily for the perusal of specialists.

edition of *The Moors in Spain* by Stanley Lane-Poole will seldom find references to color but a frequent use of the word Saracen.

The Moors, according to the Oxford English Dictionary, are people who are commonly supposed to be black or very dark and it is synonymous with the word for “Negro” in many contexts. Rashidi and Brunson provides numerous examples of the synonymy of Moor with Black during the European Renaissance and earlier. The word runs like a ripple across a vast pool of languages.

“During the European Renaissance, explorers, writers and scholars began to apply the term Moor to Blacks in general. A prominent example of this tendency can be found in the work of Richard Hakluyt, a fifteenth-century traveller. Hakluyt recorded that, “In old times the people of Africa were called *aethiops* and *nigritae*, which we now call *Moors*, *Moorens*, or *Negroes* ... In the Romance languages (Spanish, French and Italian) of Medieval Europe, Moor was translated as *Moro*, *Moir*, and *Mor*. Derivatives of the word Moor may be found even today in these same languages. In Spanish, for example, the word for blackberry is *mora*—a noun which originally meant Moorish woman. Also in Spanish, the adjective for dark-complexioned, which now means brunette, is *moreno*. We find a similar legacy in the French language. In French *moricaud* means dark-skinned or blackamoor, while *morillon* means black grape. Again, as in the Spanish, the Italian word *mora* means Negro or Moorish female. Also in Italian, *mora* means blackberry, while *moraiola* means black olive.”

As pointed out above, the Arabs rarely used this word. In Arabic literature the word *Moor* was fairly non-existent and the term Berber was applied to practically all the inhabitants of the Maghrib (Islamic North Africa west of Egypt). The Arab use of the word Berber presents further difficulty since the term embraces many clans, not all of whom are Black. It is because of this that Rashidi and Brunson, as well as the anthropologist Dana Reynolds, have gone to the trouble in certain contexts to identify those Berber clans of Africoid or predominantly Africoid origin.

The most important identifier, of course, is to be found in medieval painting and sculpture. It is claimed that certain Islamic traditions inhibited the representation of the human image in the work of Muslim artists and even in cases (some medieval Persian art, for example) where this inhibition does not seem to have obliterated portrait art, the human image is often frozen, non-individualistic and unreal. We are grateful, therefore, that, in spite of their prejudices, the Christians left vivid images of the Muslim Black. While the Black figure at times takes on a demonic quality or emerges as an exaggerated caricature of the African, these paintings and sculptures are an indisputable witness to his presence and importance in this period.

Such illustrations are to be found in the Cantigas of Santa Maria, allegedly written by Alphonso X (1254–1286). They are filled with images of the Moor

and are mostly Black types. This is the period of the Almoravid invasion which brought hordes of new Africans into the Iberian peninsula. Medieval illustrators in the *Cantigas* portray Blacks in a variety of roles – from members of the aristocracy to the military. Included among the images of medieval Spain is a Black man receiving gifts from a caliph or emir. In another illustration two noble black Moors are shown playing chess while being attended by black and white servants and musicians. Also, in the army of the Almoravid, black Moors are shown not only as foot soldiers, bowmen, lancers and horsemen but high-ranking officers. This needs to be emphasized since historians have repeatedly presented Blacks in these contexts as mere palace guards, harem-keepers and muscle-mounted mercenaries.

Let us not pretend, however, that racism just rolled over and died when it was struck by the lightning of Islam. There were more positive black images, to be sure, in the Koran than in the Bible, far more black figures emerging as supreme powers in Islamic lands than in the lands of European Christendom. God created man of black clay, says the Koran, and the scandalous story of the curse of Ham (which gave so many bigots an almost divine justification for despising Blacks) had no place in the Islamic scriptures. Where in the legend of the early Christian world could we find figures like the black general Ubadah who commanded the surrender of Egypt from Europeans?⁷ Or a revered Black like Bilal, among the first companions of the Prophet, a third pillar of the faith, who brought the infidel forces of Syria to their knees? Search as hard as you may through the Christian pantheon of heroes and you will never find the likes of Ya'kub Ibn Yusuf, also known as al-Mansur, who ruled Morocco from 1149–1189 and invaded Andalusia twice, becoming one of the greatest of the Moorish rulers of Spain. And on what throne in Europe, save in the Muslim domains, sits one comparable to Ibrahim-al-Mahdi, black poet and musician, who became ruler of Syria in 686 AD and was elected twenty-five years later as Caliph of all Muslim Spain?

As St. Clair Drake points out, making a very serious qualitative distinction, the election by elders of a Black to rule all of Muslim Spain makes this, in spite of the presence of color prejudice, which Islam mediated but could not obliterate, very different from the system of color-caste that would eventually develop in the New World diaspora.⁸

What led to this qualitative difference? According to Professor Drake, “The cultures conquered by the Muslims adopted the Arabic language along with the Muslim religion and thus contributed to an international “Arabic” culture that was distinct from an “Arabian” culture characteristic of the Arabian peninsula. This international Islamic “high-culture” had a tendency to transform color prejudice into an attitude that was subordinated to other values ...⁹

Islam modified racial prejudices. It did not eradicate it. “In Islam, as in Christianity, there has always been tension between its universalistic teach-

ings and its application in concrete situations ... The kind of social relations that existed in specific times and places in Arabia, rather than abstract conceptions of color values, were the decisive determinants of concepts about black people and attitudes towards them.”¹⁰

Specific times and places rather than abstract conceptions ... this is very well put and brings clarity to a situation that is sometimes irritatingly ambiguous. How can the Black rise to the top of the world in some places while in others, apparently dominated by the same general conception, he is paralyzed and stifled? There are zones of relative mobility (as in Spain, which Drake calls the periphery) and zones of relative rigidity (as in Persia and Turkey, which are seen as the central lands). Even in liberalized Spain, however, there was the problem of race (but was it simply race or the rivalry between power groups?). Rashidi and Brunson note the so-called ‘bias of the Arabs’. “With the conquest and settlement of Spain” they contend “the Arabs developed patterns of racial bias towards the Berbers. This bias, sometimes blatant and at other times more subtle, manifested in various ways.” They cite disproportionate tax assessments and poor land allotments but they give an even more disturbing example of racial bigotry. After founding the Almohad dynasty, the Berber ruler *Abd-al-Mu'min* offered the post of secretary in Granada to an Arab poet, Abu Ga'far. Because Ga'far had to work beside the Black Sultan's son, he hesitated “because he felt the dark-skinned Berber was far below his own intellectual standards.” One can well understand how this asinine arrogance led to “hostile feelings, open rebellions, and shifting alliances between the Arab, Berber and Christian factions of the Iberian peninsula.”

This essay presents us also with a portrait of the Christian Moor, St. Maurice, and concludes with an introduction to the African presence in early Arabia, highlighting the African substratum of the ancient Arab world.

2. Influences and Contributions

A distinction should be drawn between the Classical Renaissance of Europe, which mainly relates to its literature and art, and the Scientific Renaissance, which began to bud and flower in the 12th and 13th centuries. Jose Pimenta-Bey deals primarily with the Moorish stimulus for the latter. He sets out to prove in his essay, and does so with a formidable body of evidence, that the foundation of much of medieval Western science and its academies was built up upon the transmissions, refinements and discoveries of the Arabs and the Moors.

Moorish influence came primarily to the West by way of the Iberian peninsula (renamed al-Andalus by the Moors). Bey provides us with a detailed examination of Western Europe's scholarly relations with Spain. Trans-

lation, of course, played the major role in this diffusion of the sciences. The schools of translation were like the bridges between the Muslim and Christian scholars. Chief among these was the school of translators founded at Toledo by Alfonso X during the thirteenth century.

Translations from Arabic (the medieval language of science) into Latin, the classical European language, had been going on since the tenth century. Centers of translation sprang up all over Christian Europe—Barcelona, Tarazona, Leon, Segovia, Pamplona, Toulouse, Beziers, Narbonne, Marseilles.

Bologna, Salerno and Paris made extensive use of Moorish scientific treatises. The translations from the Arabic provided links between Spain, Portugal, France, Italy and England. Alphonso X promoted Moorish erudition at every opportunity. The first university of Christian Spain was founded at Valencia by Alfonso VIII in the 13th century and the teachers employed were the Muslims and the Jews.

Nearly all the major universities in Europe sprung up around the same time, beginning in the second half of the 12th century right up through the 13th, a span of about one hundred and fifty years, a period which coincides with the flowering of Moorish science and the establishment of centers in Europe to translate Moorish treatises from Arabic into Latin. In Italy we have Bologna, Padua, Naples, Rome; in France, Montpellier and Toulouse; in Portugal, Lisbon and Coimbra; in England, Oxford.

Several of the Moorish works in mathematics, astronomy and medicine became standard texts at these universities. For example, Judwal, a Moorish work in astronomy, became a standard text at Oxford. Frederick II founded a university at Naples in 1224 and there he established a curriculum which emphasized Moorish scholarship. Under him all theological studies ceased at Italian universities and Moorish medicine and law became the major disciplines.

A curious schizophrenia developed among the Catholics in relation to Moorish science and knowledge. On the one hand they were very much aware of the superior knowledge of the Moors and they made efforts to acquire that knowledge so that they would not be left too far behind. At the same time they strove desperately to keep it away from the common people and even, at times, to vilify it so that it would not become a challenge to Catholicism. They were afraid that the Enlightenment, the new ideas that this new knowledge would bring, could affect the populace. So that, even though they were given the keys to the inner sanctum, they kept the cage closed to the masses.

Into Europe came the advances of an empire more immense than those of either Alexander the Great or Rome at its height. Rice was introduced into Europe by the Moors in the tenth century, cotton by the ninth. A Moorish botanist, Ibn Bassal, partitioned the land into ten different classes, according to particular characteristics, and taught the farmers ways of increasing the fertility of their plots. Surveys were done to locate sweet water below the

earth. Widespread use was made of the waterwheel which the Moors had introduced into Spain. The Romans also knew of this but they had used it very little. The Moors also dug canals and channels to irrigate the farmlands and provide water for the thousands of houses and mosques and palaces and public baths. They not only increased the fertility of the soil with their new methods and tools and plants and manures but they also ushered in the sciences of food preservation and storage. They could store wheat for as long as one hundred years. Their methods of drying enabled such food as figs, plums, cherries and apples to remain edible for several years.

They have left the voiceprint of their language on the things they introduced. A lot of Arabic words have entered general usage as a result of the Moorish invasion of Europe. *Bey çites* coffee, sugar, rice, cotton, lemon, syrup, soda, alcohol, alkali, cipher, algebra, arsenal, admiral, alcove, magazine. Let me add a few to this list, selected from my own work on pre-Columbian navigation and the transfer of plants: anchor (from *angar*) caravel (from *caravos*) tobacco (from *dubbaq* and a series of *taba* and *tabgha* words).¹¹ Also, the technical terms for the *astrolabe* (an astronomical device invented by the Moors) still retain their Arabic names.

But technology in itself is not the only arbiter of civilization. It is important to note a benign African influence on the way Islam operated in Spain, particularly in relationship to women. Ibn Battuta, the Arab traveller and writer, first commented with astonishment on the level of freedom and equality of Muslim women in the African town of Walata.¹² It was the same in Moorish Spain. Unique among Islamic nations, women enjoyed more societal freedoms than in any part of the Islamic world. They moved freely in public and engaged in various gatherings. The practice of *purdah* was almost entirely ignored in Moorish Spain. Even a daughter of a 12th century Caliph had a total disregard for the veil.

A question that has always haunted me is the reason for Europe's Dark Age. Why did Europe fall into such darkness after all it had received from the Greeks who had taken so much from, and added what they could to, the Egyptian sciences? G.G.M. James, in *The Stolen Legacy*, answers this question. James had pointed out that the edicts of Theodosius in the 4th century closed down the temples of the Egyptian mysteries as well as the philosophical schools of Greece. The emperor Justinian in 529 A.D. followed in the same path of Theodosius. Thus an intellectual darkness descended over Christian Europe and the entire Greco-Roman world. It lasted for centuries. But I feel James exaggerates when he claims that "the Greeks showed no creative powers and were unable to improve on the knowledge they received."¹³ His point about their borrowings is well made but this kind of chauvinistic remark is quite unnecessary. There is no need to suggest the Greeks were dumb and could make no improvements whatever on what they learnt. If that were true, the influence of the Egyptians would have been negligible.

But James makes an even more important point which I have not seen repeated elsewhere. It is the missing link in the drama of Moorish scientific ascendancy in the Middle Ages. Eurocentric historians had argued that the Arabs were merely transmitting the Greek heritage lost to Europe during its Dark Age. Even Arabs were made to believe that and to assume that they were standing on the shoulders of Greek giants. By the time they attacked Egypt, Europeans had long been in charge of that defeated country. The Arabs seemed to forget that their conquest of Egypt had been made easy by the resentment of the Egyptians against their Byzantine overlords. We know far more today about the enormous debt Greek science owes to Egypt (see my essay "The Egyptian Precursor" in this issue). But what was little suspected was that Greece was not the only conduit of Egyptian scientific genius to the Arab world. James provides evidence that there were Egyptians fleeing their country in large numbers during the Persian, Greek and Roman invasions, fleeing not only to the desert and mountain regions but also to adjacent lands in Africa — Arabia and Asia Minor, where, "they lived and secretly developed the teachings which belonged to their Mystery System. In the eighth century A.D. the Moors of North Africa invaded Spain and took with them the Egyptian culture which they had preserved. Knowledge in the ancient days was centralized, that is, it belonged to a common parent and system — the Wisdom System or Mysteries of Egypt, which the Greek used to call Sophia."

Whatever we may say of these great scientific advances, there is something that we cannot gloss over and which unfortunately we must mention in our uncompromising quest for the truth of history. Some despots and merchants did trade in slaves during part of the Moorish occupation of al-Andalus. Most of these, before the European slave trade were European slaves. It has been said that slavery among the Muslims and slavery among the Catholics had important differences. Bey quotes Joseph O'Callahan who, in *The History of Medieval Spain*, makes it clear that "owners did not possess the power of life and death over them nor could they inflict excessive punishment. Slaves had rights and they could actually seek assistance if they were exceedingly maltreated." On this matter Bey comments "any student of American history knows that this was far from the case regarding the British and United States system of enslavement. The enslaved African was a non-human legally designated as 'property'."

Slavery, regardless of these qualifications, can never be condoned or forgiven. But it was not central to their system: it was marginal. I think it should also be pointed out, contrary to myths about the Muslims, that they did not force their religion down the throats of the Christians. John Jackson, in an informative chapter on the Moors, in his book *Introduction to African Civilization*,¹⁴ shows us how Christian, Jew and Muslim were treated with equal respect during the dynasty of the Ummayyads. We have been given no evidence that this changed dramatically in later Muslim dynasties. The slave

trade in this time was not a state institution. It was like the lucrative drug enterprise of today — a large but lawless thing, sometimes indulged in by bad rulers but not a keystone of the system, as it was later to become in the Euro-Christian world. The Moors, let it be said, did not suppress the languages of the people of Al-Andalus, they did not outlaw their sacred customs, they did not turn Iberia into a sweat-shop, its fertile lands a mere source of raw materials for the Muslim international elite. They did not destroy their legal system, rob them of their political rights, deny them their claim to humanity. The one thing they did insist on, was a say in the election of the Catholic bishops since the rival power of the church could undermine Muslim power and authority.

...

The world changed dramatically in 1492, not only because Columbus stumbled in the direction of the Americas, using the magnet of a myth to draw millions behind him, but because that was the very year the Moors were defeated. It is not an accident that it is Spain and Portugal who spearheaded the movement in this direction. It was on Jan. 2, 1492 that the African leader, Abu *Abdi-Llah*, otherwise known as Boabdil, surrendered to the Spanish.

Jan Carew compares the illiteracy of the Christian Europeans to the learning and erudition of the Moors of that time. The comparison is so startling, his comment is worth quoting.

"At a time when the most insignificant provinces of Moorish Spain contained libraries running into thousands of volumes, the cathedrals, monasteries and palaces of Leon, under Christian rule, numbered books only by the dozen. The paltry number of texts the Christians did possess were almost all devotional or liturgical."

The narrowness of vision this produced among leaders of the church and state was to have catastrophic effects. It led to the massive burning of African and Arab books under the order of Cardinal Ximenes de Cisneros. It inspired a similar bonfire of the books of native Americans. Bishop de Landa exhorted his followers in the Yucatan "Burn them all — they are works of the devil."

The destruction of the Moorish libraries was particularly vicious because it was not only inspired by religious narrowness and bigotry. Hatred of the dark invaders kindled the bonfires. The Church at that time too saw most of this foreign learning as something evil, even demonic. The number system that we use today, for example, brought in by the Moors from India, was seen as late as the 17th century in some parts of Europe as signs of the devil. It became a religious mission for men like Ximenes and his successors to erase from history all memory of the Moors. Ximenes even induced the Spanish sovereigns to outlaw the public baths, making cleanliness antithetical to godliness. Fortunately for the scientific renaissance, key Moorish works had already been translated and circulated, even smuggled secretly into the academies, significant seminal inventions introduced and established before these barbaric attempts at an intellectual holocaust.

Beaten into surrender, forced by the million to seek refuge back into Africa and Arabia, some of the Moors still held their ground. An important rebellion by the Moors is cited by Carew in 1568 led by Maulvi *Abd-Allah* Mohammad ibn Umayya. This was such a serious rebellion that Philip II of Spain had to call on Don Juan of Portugal to put it down.

Carew deals with the subtle evasions by Europeans who refuse to admit that the Almoravids (1056–1147) were Africans. “They continue to describe them variously as: ‘descended from the Sanhaja tribes of the Sahara’ or ‘the desert Sanhaja from whom the Almoravids had first drawn support’ suggesting the Almoravids, themselves, were of a different race and that they got the Sanhaja to help in their campaign; or ‘the African troops, the Sanhaja’ ...

While he notes that the Arabs later developed a myopic vision of history, ignoring the African contribution, he praises the early Muslim open-mindedness. For, after all, Islam went beyond the Arab and, in its early revolutionary phase, its eagerness to embrace the universe of man’s imaginings was extraordinary. “Unlike Christian theologians who forbade scholars from considering ideas outside of the prescribed ecclesiastical canons of the day, Islam accommodated new ideas with grace and a civilized tolerance.” Let me quote from him again since he highlights the advantages of this kind of dynamic openness very well:

“Muslim scholars absorbed and synthesized and expanded upon the knowledge of the Ethiopians and Egyptians, the Phoenicians, the Greeks, the Chinese and the Indians. A new and momentous leap forward in the theoretical and applied sciences evidenced itself in Moorish mathematics, medicine, astronomy, navigation and new concepts of world geography and philosophy ... The popularity of Moorish scholarship was such that for centuries Arabic was commonly accepted as the language of scholars from Europe, Asia and Africa ...”

His essay is particularly illuminating when it comes to the discussion of agriculture. The Moors transformed the Iberian peninsula in this respect. They were able to create a harmony in the rhythms of the life in the city and in the countryside. They not only brought advanced drainage and irrigation systems, reservoirs, aqueducts, sophisticated storage facilities and efficient marketing, transportation and trading networks but they brought the beauty and freshness of the countryside into the cities — fantastic gardens, parks, lush inner courtyards and a constant supply of pure water. They also brought a variety of new crops like cereals, beans and peas of various types, olives, almonds and vines — rich new sources of protein. Fruits unknown to Europe tumbled into the market — oranges, pomegranates, bananas, coconuts, maize and rice. They brought the art of dry farming, as well, to the high bleak plains and they introduced the water-wheel (as I mentioned earlier) an invaluable source of energy for irrigation and the grinding of grain.

The impact of the Moors upon European literature and upon the work of great writers like Cervantes and Shakespeare, is also rarely discussed. Carew points out that Spain’s greatest literary figure, Cervantes, was for several years prisoner of a Moorish leader in North Africa. The tales of knight errantry and courtly love, which obsess Cervantes’ hero, Don Quixote, were filtered through centuries of the Moorish/Islamic experience. There were Moorish brotherhoods that may be described as orders of knights. Their imprint on European heraldry, on shields and emblems of chivalry, is dealt with elsewhere in this work.

Now Shakespeare, though he never travelled, had many merchant friends from whom he could milk information about Morocco and the Moors. He also knew Queen Elizabeth’s ambassador to Morocco and the Moroccan ambassador to London. Shakespeare also, I should point out, read Leo Africanus’ *Geographical Historie of Africa*, and quotes actual sentences from this in his play on Othello, the Moor.¹⁵ He wrote an ode to his Moorish mistress, Lucy Morgan of Clerkenwell,¹⁶ and seems to have taken a greater interest in the black figure than any other English dramatist of consequence. Carew touches on his treatment of these, from the noble Moor, Othello, to the caricature of the black slave, Caliban, round whom the racist prejudices of Elizabethan England are crystallized, to the dark-complexioned prince of Morocco, whose color is cancelled out (in his rivalry with the pink prince of Aragon for the hand of Portia) by what Shakespeare sees as the grand equaliser — wealth and class.

The image of the Moor in European literature, however, an occasional though powerfully evocative figure in the plays, novels and canvases of major European writers and painters, seems rather minimal in its effect on literary or artistic structure and form. Not so in the matter of music. The influence of African and Arab musical instruments, poetry and song, even musical theory, on the melodies and rhythms of Spain, shine through the lies and evasions of musicologists to this day. Yusef Ali, drawing upon a comprehensive body of work on this subject, tries to set the record straight.

A major misconception about African music is that it has always been separable from what became the Arab-speaking countries of the Mahgrib — Morocco, Tunisia, Egypt and the Sudan. The tendency of most people, even scholars who should know better, to confuse ancient and modern social and ethnic reality, has led to serious misunderstandings about racial and cultural origins of the peoples of North Africa as compared with Africans in other parts of the continent. The Mahgrib is seen as “a thin finger of Islamic culture that stretches from Egypt to the Atlantic” and what it was before the advent of Islam or the European slave trade is ignored or forgotten. We shall not attempt to prove here, since we have done so definitively in other volumes, that Egypt, in the classical dynasties at least, was predominantly African, but what is

seldom recognized is the African substratum of ancient Egyptian music. This music was to spread and influence both the eastern and western world. It haunted and startled the Arab, even as he was startled by the pyramids and sphinxes and colossal monoliths, which in his desert habitat he had never seen. Experiments in ancient Egypt with a music notation system and the establishment of schools of music that not only taught vocal and instrumental performance but also theory and chironomy (the art of notation by means of gesture) made Egypt the first civilization to do so.

Egyptians, even as late as Greek times, were still possessors of canted knowledge in both music practice and theory. Thus, much that we credit to Pythagoras and the Greek music theorists have deeper roots in Alexandria and the Nile Valley. In addition, the legacy of ancient Egypt is found in the shapes, tunings and playing styles of such folk instruments as the argul double-clarinets, the genibri of North Africa, the many endblown flutes of the near East, the hlam of the Wolof and the sistrum of the Ethiopian Copts.

Ali devotes a long section to acquaint his readers with the spread of the Arabic language east, north and west across Africa. What he is trying to say (and the Encyclopedia Britannica adopts the same attitude towards this problem) is that since any Arabic-speaking African would be referred to as an Arab, one can be misled into making clear-cut distinctions between the "Afro-Semitic" or "Euro-Asiatic" Arabian and the Arabic-speaking African since there are so many instances where such distinctions would either be blurred or misleading. He thereby avoids the racial problem to some extent by seeing the "Arab" moreso as a linguistic and cultural grouping rather than someone with a clear-cut racial identity. This approach has the value of freeing him to discuss the innovation and impact of the alien invaders on Andalusian music without having always to distinguish the fair-skinned Arabian (say) from the dark-skinned Berber of the medieval period. It is an approach, however, that has its dangers since the stage may be spotlighted with singers and players who are sometimes marginal in an examination of the African contribution to the music of the world.

Music performed by the Berbers of Morocco, he demonstrates, is traditionally African. The black Gnawa (a community or tribe of griots or storytellers) perform a large part of the traditional music. They are also found in Tunisia and among the Wolof of Gambia. Ali points to a mixture of styles (as among the Wolof) and emphasizes that this synthesis, reflecting both a Muslim and a pre-Islamic African element, may be found throughout the fringes of the Sahara.

He cites the work of an important African musicologist Kebede who asserts that an indigenous and truly African style of music cuts across Africa north to south and east to west. Kebede says that Egyptian civilization is the cradle of music and that even the Greeks refer to Egypt as the source of their

musicopedagogic ideas. Ancient Egyptian music is preserved today in the music found in the Coptic churches and it is also deeply rooted in the music characterized simply as Arabic.

The controversy over the African root of the Berbers which runs through the essays of Reynolds, Chandler and Bey flares afresh in the citations of Ali. Graeme tells us that the music of the Berbers has nothing whatever to do with Arab influence but represents an ancient African style.

What is remarkable and brings us back once again to brood upon the inspirations of Egypt is that the Arabs came there with their poetry but nothing formally set to music. They did not yet have a classical form of music that they could call their own. There is no evidence of musical treatises in Arabic, Ali informs us, until the eighth century. This is after their invasion and their study of Egyptian music practice and theory, as translated and transmitted by the Greeks. Virtually all European scholars, however, claim a Persian origin of Arab music even though they know (or at least should know) that the first Persian musical treatise dates from the twelfth century, about 400 years later.

The most significant of the Moorish musicians was Ziryab. He arrived in Spain in 822. He was known as Ziryab (the Blackbird) a name given to him because of his black complexion, his eloquence and the melodious sweetness of his voice.

Ziryab made not just an impact on the music of Spain, especially in the development of the lute but he became the cornerstone of Spanish musical art. In Cordova he founded the first conservatory of music. He also invented a plectrum made of eagle quill instead of the wooden one that had been used before. He was deeply versed in every branch of art and he was gifted with such a remarkable memory that he knew by heart upwards of one thousand songs with their appropriate airs.

Before Ziryab the lute was composed of only four strings which may be likened to the four elementary principles of the body. They expressed the four natural sounds. He added another red string and placed it in the middle which considerably improved the sound and made it more harmonious. The theory of humours which the Egyptians introduced into medicine and which had been picked up by the Greeks (and, through their translations, by the Arabs) was now transferred to music. The object of music was to restore the equilibrium of the soul in the same way that medicine was supposed to restore the equilibrium of the body humors.

Ziryab became the most fashionable arbiter of taste in the ninth century. He affected the way the upper class of Andalusia ate at table. He was the first to introduce crystal tableware. He changed hairstyles. He introduced new customs in perfumes and deodorants, in the manner of washing clothes, in cooking. He brought in new dishes, some named after him. He introduced new fashions in dress, a greater range of colors and textures of garments to

suit the shift and change in seasons. He revolutionized the style of serving and eating food. Food was no longer served in one mass as was the general case in al-Andalus before him. Following his lead, it was broken down into separate courses, beginning with soups and ending with desserts.

Apart from musical composition, instrument-making achieved a high state of development in Moorish Spain. Some of the new instruments include the khayal, the carrizo (reed) the lute, the rata, the rabel or rebec, the kanun (harp), the munis, the quenira (a type of zither) the guitar, the zolami (oboe) the shokra, and the nura (flutes). Other wind-instruments mentioned are the pastoral flute, the Moorish pipes, two kinds of flageolet and the bagpipes. The percussion instruments include the bambrel, the tambourine, castanets, brass rattles, macara and atambor.

Even when the Moors had been defeated and Christians had reconquered the territory once occupied by these people the music was imitated by a great number of Christian Europeans and the Christian kings still kept Moorish musicians in their employ even as had the Moorish kings before them.

Ali refers to a study of songs in the *Concionero de Palacio*, which contains the instrumental and vocal compositions of the Moors who were the professional musicians at Alfonso X's court. Of the hundreds of songs examined, in this work and the *Cantigas of Santa Maria*, the vast majority fit the pattern of the Andalusian metric system and are in the *zajal* form the Moors created in Andalusia towards the end of the ninth and the beginning of the tenth century. Their influence on musical instruments in Europe was considerable. They were the first to introduce a scientific description of musical instruments and possessed the only didactic instrumental methods in music during the Middle Ages. While most commentators agree with this, they insist that their influence was confined to that category and that they contributed nothing to musical theory. The historian of music, George Henry Farmer, points out, however, that since there was such an advanced state of instrumental music it would be difficult to deny that some practical theory would have also been passed along. Indeed, says Farmer, "I believe, with others, that the major mood due directly to the accordatura and fretting of the Arabian lute was among the new musical ideas introduced in this way. He also cites evidence for the transmission by the Moors of practical theory.

• • •

Mamadou Chinyelu deals with the pivotal role of Africans in the birth of the Islamic faith and shows that they figure not only in the Prophet Mohammed's lineage but in his upbringing and development.

St Clair Drake points out and with supportive evidence that Mohammed himself was described as being of a red color. However, the ten sons of *Abd al-Muttalib*, Mohammed's grandfather, were all, according to D.S. Margoliouth, "men of massive build and of dark colour." This would not make Arabs see Mohammed as "a black man" in the popular American sense. We must

remember that we are dealing here with polygamous families and the sons of al-Mutallib were probably not only of different wives of different races but the particular son, who fathered Mohammed, may also have married women of different races. This, therefore, would not automatically make Mohammed "black" or Africoid. Phenotypically, at least, he does not appear in that light to the Arabs. The way color prejudice had to be dealt with again and again with stern sermons by the Prophet, makes it clear that the majority of his followers could not have seen him as such. A stigmata was still attached to people with classically "Negroid" features, St Clair Drake tells us. His work is particularly informative on this delicate point.

Black Africans, however, figure very prominently in Mohammed's life. Apart from the reputed African ancestry of his grandfather, Chinyelu points out that he was reared by an African woman, Barakat, when his mother died. He pleaded with his family to raise money to free the African slave, Bilal, who not only became a pillar of the faith but his closest and most honored friend unto his death. One of his wives — May — was an African. His adopted son — Zayd bin Harith — destined to become a great general, was also an African. Mohammed held Africa in such mystical reverence that when his early followers were fleeing persecution in Arabia he advised them to seek asylum in Africa, for "yonder lieth a land of righteousness."

Africans were pivotal also in the spread of Islam. The invasion of Spain in the eighth century and the survival of the Muslim dynasties in the eleventh owe a great deal to African military prowess and leadership. Chinyelu celebrates the military exploits of *Tarik* (who conquered Spain in 711 A.D.) of Yusuf Ibn *Tashifin*, leader of the Almoravides, who routed Alphonso VI's army in 1086 (15,000 Africans facing 70,000 Europeans) assuming leadership of Muslim Spain in 1091, and of *Yakub al-Mansur* who conquered Spain and Portugal on two separate occasions to become the most powerful ruler in the world. Such was the respect these leaders inspired in the hearts of their enemies, that royal crests and coats-of-arms in Europe were emblazoned with Moorish heads.

To the influence of Moorish science on Europe we finally turn, for it is in this field that the impact of the Moors is least known and most felt. Wayne Chandler points to advances in mathematics, the solving of quadratic equations and the development of new concepts of trigonometry. He informs us that Moorish chemistry refined upon gunpowder invention in China and thus introduced the first shooting mechanisms, known as firesticks. They were also known for their skill in medicine. For seven centuries the medical schools in Europe owed everything they knew to Moorish research. Vivisection as well as dissection of dead bodies was practiced in their anatomical schools and women as well as men were trained to perform delicate surgical operations. They were the first to trace "the curvilinear path of rays of light through air." This discovery in about 1100 AD is a prerequisite to the design of corrective eyeglasses. Students and teachers should read this essay also for its

outline of main events in the dynasties, which no other writer in this volume attempts except John Jackson. Jackson's single-stranded definition of the Moor, however, does not begin to address the complexities of the problem.

Beatrice Lumpkin and Siham Zitler focus upon the work of mathematicians in Africa during the Muslim empire. Most of this work was done at the Dar-el-Hikma, the House of Wisdom, founded in Cairo in 1005 AD. These scientists, through the use of Arabic as the common language of learning, were able to communicate with their colleagues over vast stretches of territory under Muslim influence, from Spain and Italy on the West across Africa and Asia, to China on the East. They promoted the rapid progress of technology in this period. Even before the House of Wisdom was established we have evidence of complex machines developed outside of Europe — self-operating valves, timing mechanisms and delays, worm and pinion gears, operated hydraulically, even crankshafts. The first steam engine had already appeared in Africa, built by Heron in the Egyptian city of Alexandria. Also, the water clock and the thermometer. Europe lagged behind in the technological race and later profited immensely from these innovations.

Edward Scobie deals with these aspects of Moorish science that made the global expansion of Portugal possible. Why did the British, French, Dutch and Italians who owned the ships not undertake this journey? Since their leaders also possessed the necessary vision for such an enterprise, why didn't they take the lead? The Portuguese jumped ahead because they drew upon everything they could from the Moors. The geographical lore (for the Muslims travelled the length and breadth of the then known world and wrote the most meticulous travel accounts (Ibn Battuta and Ibn Hawkel, for example). All the advances in navigation — lateen sails, astrolabes and nautical compasses, astronomical tables, tubes, to the extremities of which ocular and object diopters were attached, the measurement of time by pendulum oscillations, the finest maps. Also, gunpowder and artillery (the Moors had not only made the firestick, as mentioned above, but even cannon forged from wrought iron).

Prince Henry the Navigator (born 1394) gets all the credit for the impetus towards Portugal's expansion as if this was a result of his creative genius. The depletion of precious metals in Europe due to the demands of foreign trade, the costly wars that were taking place, leading to even further shortages, pushed Europe to turn to Africa as an untapped source. But it was Prince Henry who channeled both this need and the science of the Moors to spearhead European expansion. As Professor Hamilton puts it "it was both the lore and the lure of Africa."

Why did the perception of the Moor change? Why was there no doubt before 1492 that one was dealing with a mix of racial types speaking Arabic,

among whom the Black African was at times a dominant figure, whereas in 1992 it would seem like racial chauvinism to suggest that Africans played a major role in the occupation and enlightenment of a critical part of Europe?

The crash of Moorish power in the middle of the thirteenth century (although this lingered on in enclaves like Granada until 1492) was to make a tremendous difference. It is not an accident that the year Columbus sailed was the same year the African generals in Granada surrendered to Ferdinand and Isabella. Not only did the economic and political fortune of Africa fall dramatically after that but so did the very image and perception in which its people were held. It was only a matter of time before it would be seen in all lands and in all phases of history as unrelated to significant cultural and scientific development. Wherever it could be shown that the African had made early and significant advances, or had influenced other civilizations, be it in North Africa, Southern Europe or Egypt, it would be seen as a direct result of some Caucasoid minority in their midst or the infusion of European blood. This led European historians to assume that there had to be a Caucasoid origin of, (or a Caucasoid class or caste above) such extraordinary people as the Moors.

•••

Egypt, the depository of traditions of incalculable antiquity, had submitted, after a brief and determined struggle, to the common fate of nations, and the banners of Islam floated in triumph from the towers of Alexandria and Memphis. It was with a feeling of awe and wonder that the fierce, untutored Arab gazed upon the monuments of this strange and to him, enchanted land. Before him were the pyramids, rising in massive grandeur upon the girders of the desert: the stupendous temples: the mural paintings, whose brilliant coloring was unimpaired after the lapse of fifty centuries: the group of ponderous sphinxes imposing even in their mutilation: the speaking statues, which facing the East, with the first ray of light saluted the coming day: the obelisks, sculptured upon shaft and pedestal with the eternal records of long extinguished dynasties: the vast subterranean tombs, whose every sarcophagus was a gigantic monolith: and the effigies of the old Egyptian kings, personifications of dignity and power, holding in their hands the symbols of time and eternity ...

The influence produced by the sight of these marvels on the destiny of the simple Arab, whose horizon had hitherto been defined by the shifting sands and quivering vapors of the desert, by whom the grandeur and symmetry of architectural design was undreamt of, was incalculable ...

History of the Moorish Empire in Europe
(S.P. Scott, 1904)

Professor Scott may have exaggerated the simplicity of the desert-tribes who overwhelmed Egypt in the seventh century A.D. but, with respect to the impact of Egyptian science on the later Muslim invaders, the vaulted tone of the above passage carries not the slightest hint of exaggeration. The irony is that the Muslim invaders came upon inscriptions and papyri that they could not read. They were therefore to draw upon the vast body of ancient science second-hand, through the translations of the Greeks, the students rather than the teachers. Thus even they, in spite of their later refinements and advances, subscribed to the notion that they had merely built upon an original European base and that their real contribution to the scientific renaissance in Europe was largely to preserve and transmit the lost secrets of a Hellenistic heritage.

This notion pervades even the latest works done on the science of the Muslim peoples. Rom Landau, in his recent book—*The Arab Heritage of Western Civilization*—repeats this like a compulsive chant in every chapter. “While Europe lost the Greek legacy” he claims “the Arabs discovered it.”¹⁷ Again ... “The Arab assimilation of the Greek treasure forms one of the most fascinating chapters in the history of man’s quest for knowledge.” Two pages later he is still chanting the same tune: “They gradually erected on Greek foundations an intellectual edifice of their own ... No field of Greek learning, from philosophy to math, medicine and botany, was neglected.”

Since most modern Egyptians represent a dramatic departure, both racially and culturally, from the Egyptians of the dynastic era and have been taught, by both British and French imperial powers, to follow the Eurocentric approach in these matters, we will find this dismissive attitude towards the science of ancient Egypt even in the most devout, the most learned of Muslim scholars. Such is the case of Seyd Hossein Nasr, author of the most recent encyclopedic work on the science of the Muslims.¹⁸ It exudes with a spirit of superiority over the so-called materialistic vision of the European, but in a typically schizophrenic vein, it rarely ever mentions pre-Islamic Egypt as having a scientific tradition. It is the same Eurocentric chant in spite of his chauvinism. Praise be to Allah for Aristotle and Plato, Pythagoras, Euclid, Hippocrates and Galen. We have gone beyond this, sure, but before these Greek spirits there is nothing but the womb of space.

That is why I have found it necessary to outline important aspects of Egyptian science as it bears not only upon the Greek but upon the later invaders of Egypt. (see my chapter “The Egyptian Precursor to Greek and “Arab” Science”) which illustrates, in a courtroom judgement, the case against the main Greek plagiarists, Archimedes and Pythagoras. A later version will provide supplements to this indictment. It is important that readers be made aware of this African background since it is difficult, if not impossible, to distinguish at all times African Muslims from other Muslim scientists. What we can say about Moorish science is that it was not European in its seminal

inspiration and only minimally affected by Europeans before 1492. It was a multi-cultural tradition, involving strong African and “Arabian” elements but also elements of the Hindu (the number system, for example) and the Chinese (gunpowder technology). Science ideally, is beyond racial classification. It is neither Black nor White, African nor European. What one man invents becomes the common property and benefit of the whole human race. But when there is a perceived attempt, conscious and unconscious, persevered in relentlessly over the centuries, to minimize or exclude the contribution of people of a certain race, then an emphasis upon those invisible people in history becomes a duty, a mission, a necessary corrective. It is not that we seek to denigrate the achievements of the Greek nor to subtract one iota from the contribution so loosely labelled as “Arab” but to point out that there are seminal antecedents to the Greek that are too critical and significant to be ignored, and that both an ancient and contemporary African element mixes and melts in the crucible that became the science of the Moors.

EDITORIAL NOTES

1. Ibn-l-Khattib al-Makkary, *The Mohammedan Dynasties in Spain*, trans. by Pascual de Gayangos, London, W.H. Allen & Co. 1840, and reprinted New York, Johnson Reprint, 1964.
2. Al-Makkary, *ibid.*
3. Florian de Ocampo, *Cronica General*, Medina del Campo, 1553. For this reference, see al-Makkary.
4. *Journal of the Epigraphic Society*, Vol 7, No. 171, April 1979.
5. J.A. Rogers, *Nature Knows No Color Line*, New York, 1952.
6. Diop’s paper was presented to me in three sections. The first dealt with the origins of man: “Africa: Cradle of Humanity”, the middle section with the eighth-century invasion of the Iberian peninsula by the “Arab” (Neither Diop nor the Arabs use the word “Moor”) the third section with “Africa’s Contribution to World Civilization: The Exact Sciences.” I omitted the middle section and subsequently received Diop’s approval for this deletion, prior to the final publication of the papers under my editorship.
7. St. Clair Drake, *Black Folk, Here and There*, Vol 2, p. 98. Readers are advised to consult the chapter “The Black Experience in the Muslim World”, pp. 77–184, which is probably the most honest, serious, and balanced study of racial attitudes and relationships within the Muslim World.
8. *Ibid.*, p. 116.
9. *Ibid.*, p. 101.
10. *Ibid.*, p. 86.
11. Ivan Van Sertima, *They Came Before Columbus*, Random House, New York, 1976, see chap. 11 for origin of tobacco words and p. 232 for origin of the word ‘anchor’.
12. Ibn Battuta. *Travels in Asia and Africa 1325–1354* (trans. and selected) M.A.R. Gibb, New York, Augustus Kelley, 1969.
13. George G.M. James, *The Stolen Legacy*, The African Publication Society, London, 1972.

14. John Jackson, see "Africa and the Civilising of Europe: The Empire of the Moors" in Introduction to African Civilization, Citadel Press, Secaucus, N.J. 1974.
15. Rosalind Johnson, "African Presence in Shakespearean drama" in African Presence in Early Europe (ed. Ivan Van Sertima) Journal of African Civilizations, 1985, p. 276-287.
16. Edward Scobie, "African Women in Early Europe" in African Presence in Early Europe, (ed. Ivan Van Sertima) Journal of African Civilizations, 1985, p. 207.
17. Rom Landau, *The Arab Heritage of Western Civilization*, Arab Information Center, New York, 1962.
18. H. Seyyed Nasr, *Islamic Science. An Illustrated Study*. London and Kent, U.K. World of Islam Publishing Co. 1976. Photos by Roland Michaud.

APPENDIX TO EDITORIAL

**Rebuttal to Letter of Dana Reynolds on the Tamahu
by Wayne B. Chandler**

In reviewing the summary of Dana Reynolds' section on what constitutes a Berber, several factors come to mind.

First, in addressing her statements pertaining to Berbers, I find it necessary to explain what seems to me to be the obvious. There is no question that there are groups of black Berbers in the northern countries of Africa but my task was to identify and trace the origin of a particular group or segment of this Berber population, which came to be known as the "Tawny Moor." That these so-called 'white' Moors existed is irrefutable, for there are not only litanies of written documentation but scores of painted renditions of these Berbers to remind us of their presence in the Islamic conquest and construction of North Africa and Spain. Thus it is not by my design that we are able to trace these groups through the chronicles of the Arabs, Romans, Garamantes, Carthaginians, and Egyptians. For Reynolds to refute such obvious data is uncharacteristic of her high degree of scholarship.

Using anthropology, etymology, and quoted comments from the Egyptians themselves, we have no trouble in tracing the "Tawny Moor" or white Berber to the group known as the Libyan and from the Libyan to "Tamahu."

Beside the historical accounts of these 'whites', which is demonstrated on the famed palate of Narmer-Menes (if we are taking into consideration visual evidence), and the statuary of Rehotep and consort Nofret, we have the written testimony of these 'white' Libyans on the Wady-Magharah which contains several memorials to the ancient kings of Egypt. The Wady-Magharah states that in the Sixth Dynasty, "Pepi I. was the conqueror of the Tamahu ... the foreign people who in his time dwelt in the valley of caverns [cavemen]." This is testimony from the horse's mouth. Who are we to refute it? A pictorial representation of four races of men is found on the tomb of Seti I. Of these four races, each a different color, we find men arranged in groups of four each. One of these is the European and is depicted as white as snow with the designated inscription "Tamahu."

Reynolds quotes Behrens and Arkell stating that [in the Tamahu] they identify a C-group culture which was "tall, slender, and *obviously* black ...". What makes this so obvious and who is stating this, Behrens and Arkell, Reynolds, or a third party whom Reynolds is quoting? Her statement suggests she is quoting someone else who is quoting these sources and that they have not been thorough in their research. Etymology in this case is unwavering and inflexible, and states most assuredly that the Egyptian word Tamahu means "the white people"!!! In regard to Reynolds' comments on the Tehenou, it has

been acknowledged by Egyptologists and historians alike who have correctly translated the hieroglyphs that this group was of the black race. Diop writing in 1955 states, "The Tehenu or black Lebou was probably the ancestor of the modern Lebou ... These Blacks preceded the Temehou or white Libyans in that region of the western Delta. The existence of the first black inhabitant, the Tehenu, made it possible to create confusion over the term "brown Libyan ..."

As historians, it is our responsibility to convey an accurate account of what has transpired in our past. We must at all costs refrain from the same tactics employed against us by the European historian for, as we have seen, this approach leaves a void which is easily filled with the truth, making it easy to refute all lies and scholarship which is based on deception.

That among the predominant black types, there was also an Euro-Asiatic species of man in Egypt from a very early historical period is fact. That they in later times came to be known as Libyans is also fact. That these Libyans amalgamated with the indigenous blacks of the area which eventually produced what came to be called the "Tawny or white Moor" is also irrefutable. Reynolds cannot afford to misrepresent the historical ledger because she wants to paint the entire population of Africa as black when there is substantial evidence to the contrary.

I have no doubt that, in most cases, Dana Reynolds' approach to history is impeccable but in this matter I find an oversight in her categorizing of the Tamahu and their relationship to the Berbers. I do agree, however, with her assessment of the black Libyans and the historical role they have played during and after the Arab conquest.

THE MOORS IN ANTIQUITY

by James E. Brunson and Runoko Rashidi

According to the *Oxford English Dictionary*, the Moors, as early as the Middle Ages and as late as the seventeenth century, were "commonly supposed to be black or very swarthy, and hence the word is often used for Negro." There is considerable difficulty, however, in determining the ethnicity of the early Moors through terminology alone. Indeed, there are several terms that have been used to identify the Moors. Arabic texts, for example, rarely used the word *Moor*, and instead applied the term *Berber* (a word thought by some to be pejorative) to the early non-Arab peoples of northwest Africa. And when not employing that term, they utilized the clan names of the Berbers themselves. In addition, early Christian sources often applied the term *Saracen* indiscriminately to Muslim populations in general, including the Moors.

The Term Moor

Although scholars generally agree that the word *Moor* is derived from *Mauri*, there are profound disagreements on what the word originally meant and how it was applied. Philip K. Hitti contends that the term *Moor* has a geographic designation meaning *Western*. Hitti, the author of the comprehensive *History of the Arabs*, writes that:

The Romans called Western Africa Mauretania and its inhabitants Mauri (presumably of Phoenician origin meaning 'western'), whence [the] Spanish *Moro*, [and the] English Moor. The Berbers, therefore, were the Moors proper, but the term was conventionally applied to all Moslems of Spain and north-western Africa.¹

Using Greek and Roman sources, Frank M. Snowden has pointed out that the *Mauri* (a northwest African people whose color received frequent notice) were described as *nigri* (black) and *adusti* (scorched).² The Roman dramatist Plautus (254–184 B.C.) maintained that the Latin word *Maurus* was a synonym for *Niger*. In contrasting the Moors of the sixth century with another racial group in North Africa, Procopius (ca. 550) wrote that they were "not black-skinned like the Moors."³ Isidore, a Catholic scholar and the Archbishop of Seville (587–636) wrote that the word *Maurus* meant *black*.

With the sudden eruption of the Arabs, during the middle of the seventh century, *Mauri* disappears for a time from the historical records. It reemerges,

however, in medieval literature. For example, in a Middle English romance called *Kyng Alisaunder* (ca. 1175), the conqueror Darius has among his troops a contingent of soldiers led by *Duke Mauryn*. Regarding *Mauryn*, J.B. Friedman writes that, "... it sounds rather like Moor in this context."⁴ As late as 1398 we find the following reference to the Moors: "Also the nacyn [nation] of Maurys [Moors] theyr blacke colour comyth of the inner partes."⁵

There are Irish records of a Viking raid on Spain and North Africa in 862. During the raid a number of Blacks were captured and some carried to Dublin. In Ireland they were known as "blue men" (Irish, *fir gorma*; Old Norse, *blamenn*). The entry is under the title "Three Fragments Copied from Ancient Sources," and sheds further light on the ethnicity of the Moors. The entry reads:

After that, the Scandinavians went through the country, and ravaged it; and they burned the whole land; and they brought a great host of [the Moors] in captivity with them to Ireland. These are the 'blue men' (*fir gorma*); because the Moors are the same as negroes; Mauretania is the same as negro-land.⁶

A vital source of information regarding medieval Spain is the *Cantigas of Santa Maria*. Sponsored and allegedly written by Alfonso X (1254–86), the *Cantigas* represent a survey of secular medieval attitudes and actions. At least twenty-eight of the long poems deal primarily with Moors. One mentions Yusuf ibn Tachfin and the Almoravid conquests. This may indicate that the clearly distinct Blacks identified as Moors in most of the *Cantigas* are most intimately connected with the Almoravid invasions of Spain during the eleventh century.

Medieval illuminators portrayed Blacks in the *Cantigas* in a variety of roles, from members of the aristocracy to the military. Included among the aristocratic images of Islamic Spain is a Black man receiving gifts from a caliph or emir. In another, two "Noble Moors" are shown playing chess while being attended by Black and White servants and musicians. In the Almoravid army, Moors are shown as foot soldiers, bowmen, lancers on horseback, as well as high-ranking officers. They are also shown as menials, musicians, and Christian converts.⁷

During the Middle Ages, because of his dark complexion and Islamic faith, the Moor became in Europe a symbol of guile, evil and hate.⁸ In medieval literature demonic figures were commonly depicted with black faces. Among Satan's titles in medieval folklore were: "Black Knight," "Black Man," "Black Ethiopian," and "Big Negro." In the *Cantiga* 185 of King Alfonso the Wise of Spain (1254–86), three Moors attacking the Castle of Chincoya are described as "black as Satan." In *Cantiga* 329, an extremely black man who has stolen objects from a Christian church is identified as a Moor.⁹ In the *Poema*

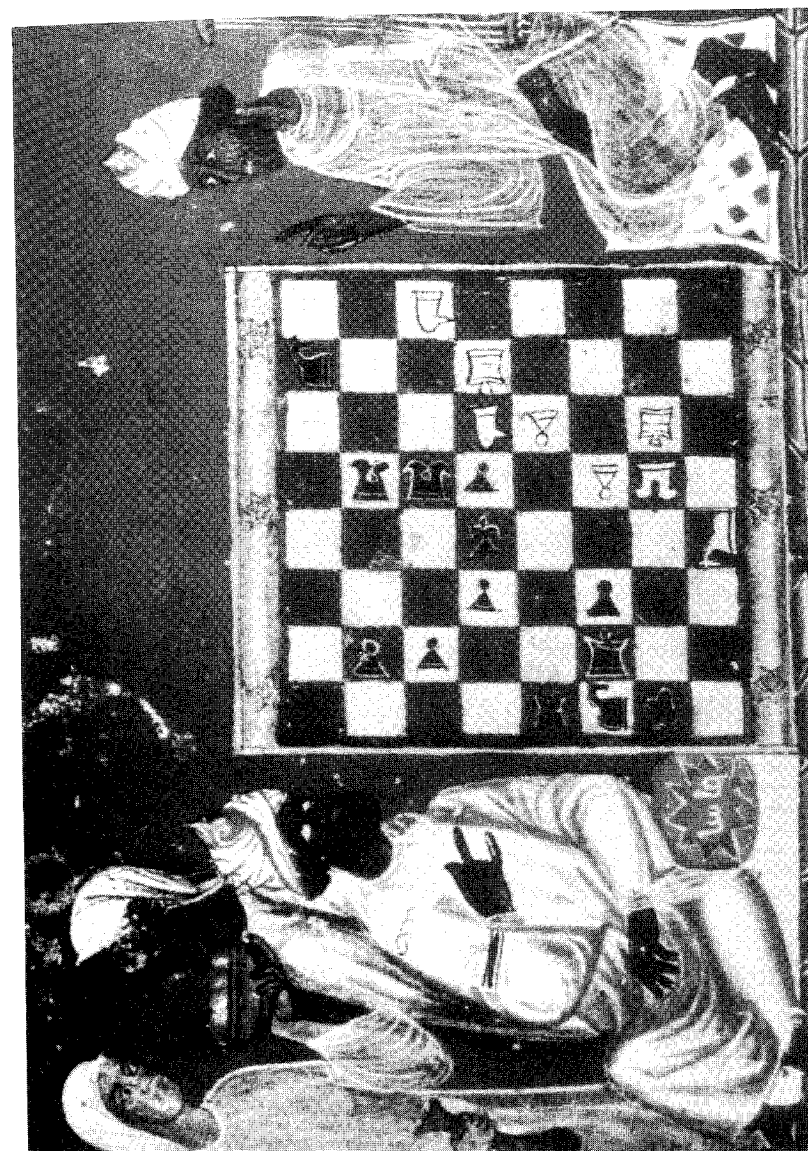

Figure 1. Moorish noblemen playing chess; from the *Chessbook of Alfonso X the Wise, Castile*. Date: 1283.



Figure 2. Expedition of Muslim soldiers to kidnap a Christian count. Note Black Moors; from the *Cantigas*. Date: 1254.



Figure 3. Detail of Muslim expedition in Spain. Note two Black Moorish soldiers; from the *Cantigas*. Date: 1254.

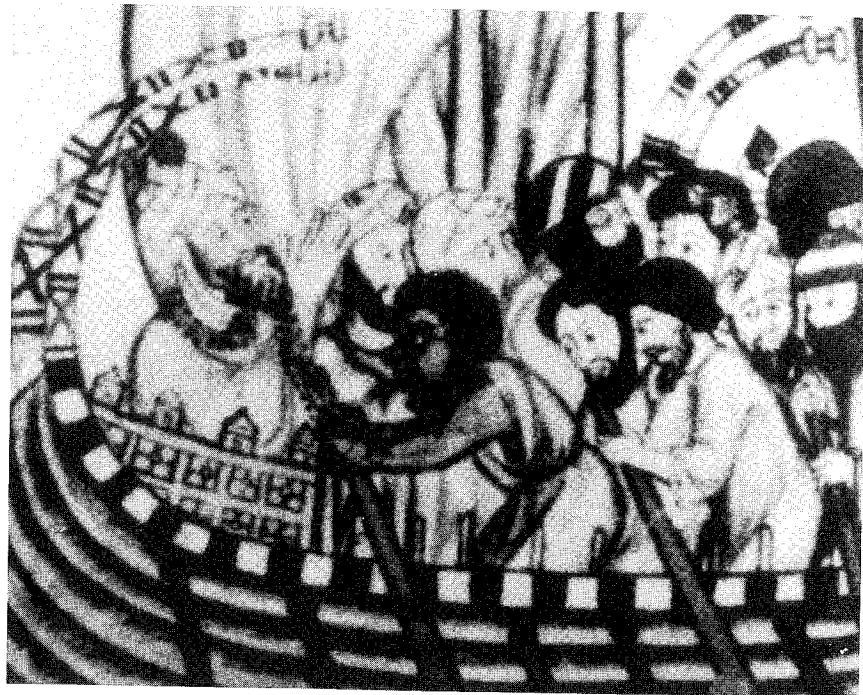

Figure 4. Muslim expedition at sea. Note Black Moor in center; from the *Cantigas*. Date: 1254.



Figure 5. Moors leading Christian captives; from the *Cantigas*. Date: 1252.

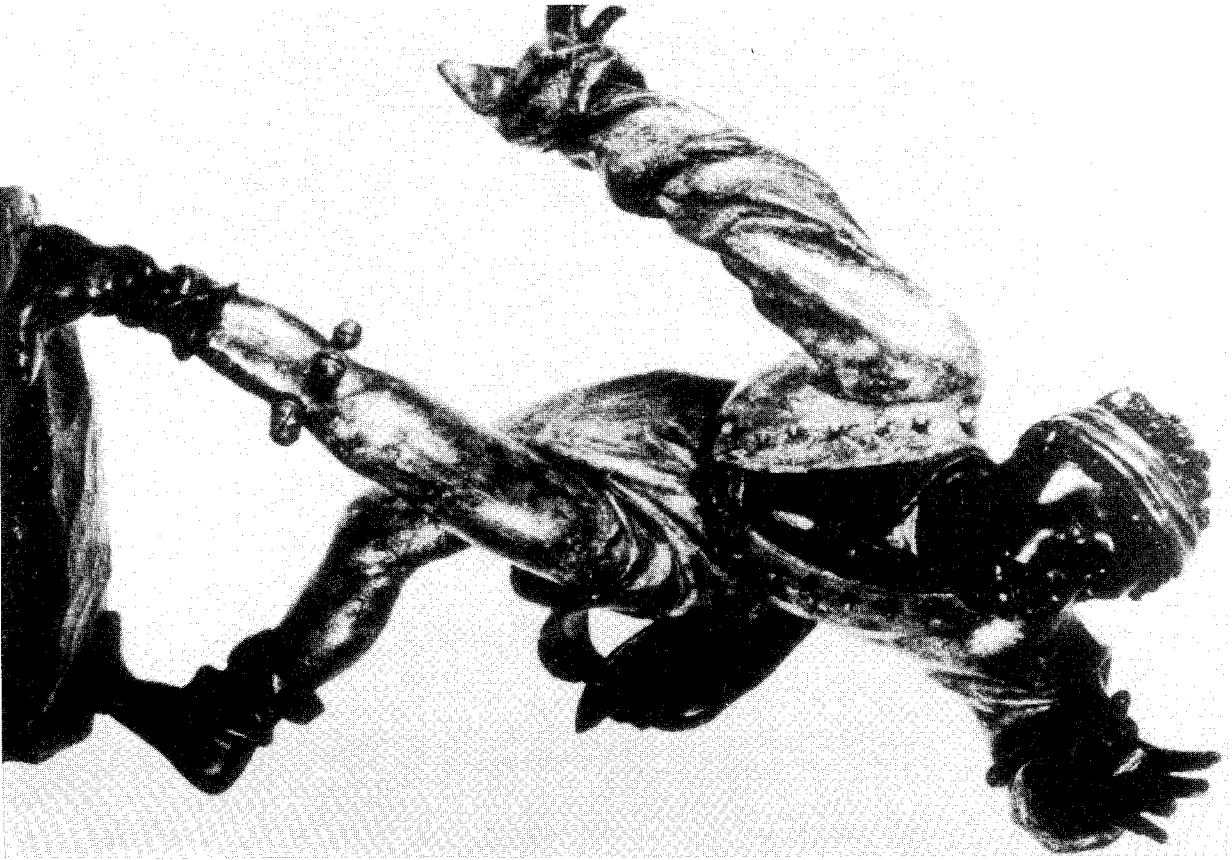

Figure 6. Moorish dancer; from Munich, Germany. Date: 1480.



Figure 7. Muslim noblemen receiving gifts from the caliph. Note Black Moorish noble on the left; from the *Cantigas*. Date: 1254.

de Fernan Gonzalez, devils and Moors are equally described as “carbonientos” — literally the “coal-faced ones.”¹⁰

French historian Jean Devisse writes that “The Castilians were at first acutely aware of the power of Black fighting men, and in time transferred the old feeling of hostility from Aethiops to the Black Moor...”¹¹ As is well known, not all of the battles during these years of Islamic domination resulted in Moorish victories. For example, during a fierce engagement in 1096 between the Moors and Spanish Christians, four Moorish princes were killed. Around 1281, Peter III of Aragon commemorated this Christian victory with the amorial bearings of a cross cantoned between four woolly-haired Moors. This coat of arms was updated by the Hapsburg king Charles on a gold coin shortly after 1700. Moors with broad noses, thick lips, and woolly heads (upon which rest crowns), dominate the coin.

During the European Renaissance, explorers, writers, and scholars began to apply the term *Moor* to Blacks in general. A prominent example of this tendency can be found in the work of Richard Hakluyt, a fifteenth century traveller. Hakluyt recorded that, “In old times the people of Africa were called *aethiops* and *nigritae*, which we now call *Moors*, *Moorens*, or *Negroes*.”¹²

Shakespearean scholar Elmer E. Stoll provides additional insight regarding the use of the word Moor as it relates to late Medieval and early Renaissance Europe:

A striking proof that the word Moor was, as among the Germans at this time, exactly equivalent to negro, is not only its use as applied to the curly-haired, thick-lipped Aaron in *Titus Andronicus*, but also the constant interchange of the two words as applied to the equally unmistakable negro Eleazar, in *Lust's Dominion*.¹³

In the Romance languages (Spanish, French and Italian) of Medieval Europe, *Moor* was translated as *Moro*, *Moir*, and *Mor*. Derivatives of the word *Moor* may be found even today in these same languages. In Spanish, for example, the word for blackberry is *mora* — a noun which originally meant *Moorish woman*. Also in Spanish, the adjective for *dark-complexioned*, which now means *brunette*, is *moreno*. We find a similar legacy in the French language. In French *moricaud* means *dark-skinned* or *blackamoor*, while *morillion* means *black grape*. Again, as in the Spanish, the Italian word *mora* means *Negro* or *Moorish female*. Also in Italian, *Mora* means *blackberry*, while *moraiola* means *black olive*.¹⁴

The Term Berber

“Strictly speaking,” writes Thomas F. Glick, “Moors were Mauri, Berbers who lived in the Roman province of Mauretania; therefore, its use stresses, sometimes by design, the Berber contributions to al-Andalusian culture.”¹⁵ In

Arabic literature the word *Moor* was fairly non-existent, and the term *Berber* was applied to practically all the inhabitants of the *Maghrib* (Islamic North Africa west of Egypt).

The term *Berber* is thought to have derived from the Latin *barbari*, an appellation equivalent to the English “barbarian,” which the Romans called peoples who spoke neither Latin or Greek. The view that the ancient Berbers were a predominantly white-skinned, blue-eyed race of Hamites has been largely shaped by recent colonial attitudes towards Africa. Another idea that seems to be gaining general acceptance is that the bulk of the population consisted of a mixture. Our view is that the Berbers emerged as the result of an intermixture between Caucasoid people (who had moved into the Maghrib by the second millennium B.C.) and the more ancient Africoid inhabitants of North Africa. Among the Berbers of North Africa, according to Roman documents, were the “black Gaetuli (Melanogaetuli) and black-skinned Asphodelodes.”¹⁶ In addition, Harold A. MacMichael points out that Africoid Blacks — the Tibbu and Tuwarek — resembling the ancient Nigritians of the Sahara, are by origin Lamta Berbers.¹⁷ The Haratin, an ancient people whose descendants now occupy southern Morocco and Mauritania, have been called “black Berbers.”¹⁸

Arab geographer Ibn Hawkal (ca. 950) considered the Tuareg to have come “originally from the Sudan, and that by their mothers they are children of Ham.”¹⁹ Wah ibn Munabhih (who died in 732) wrote that the Berbers belonged to the Black races of Ham.²⁰ ‘Uthman’ Amr ibn Bahr al-Jahiz (776–869), a brilliant Black Muslim writer, in a significant work entitled *The Superiority of the Blacks Over the Whites*, stated that “among the Blacks are counted the Sudanese, the Ethiopians, the Fezzan, the Berbers, the Copts, the Nubians, the Zaghawa, the Moors.”²¹

Included among the pastoral Berber clans were the Luwata, Zanata, Nafusa, Zuwagha, Miknasa, and Nafzawa. Among the more sedentary Berber clans were the Sanhadja, Masmuda, Kutama, Ghamara, and Hawwara. Of the clans that were instrumental in the Muslim invasions and occupation of Spain were the Nafza, Masmuda, Luwata, Hawwara, Zanata, Sanhadja, and Zugwaha.

A Muslim scholar, while discussing the Berber women of the Sanhadja confederation, wrote that, “Their color is black, though some pale ones can be found among them.”²² In the *Romance of the Cid* (Rodrigo Diaz de Bivar) with its graphic references to the Almoravids, we are further informed of the ethnicity of at least some Berber women. This group of women consisted of three hundred Almoravid Amazons led by a “black Moorish woman” named Nugaymath Turquia. “She appears in the *Primera Cronica General* of Alfonso X (El Sabio), king of Castile and Leon (1252–84). The *Primera* was completed about 1289 under his successor Sancho IV. The events are associated with the Almoravid siege of Valencia after the death of the Cid. Nugaymath Turquia is the leader of a band of three hundred Amazons. They are negresses,



Figure 8. Moors as envoys before the anti-Christ. Propaganda work of Spanish artists. Date: 1400.

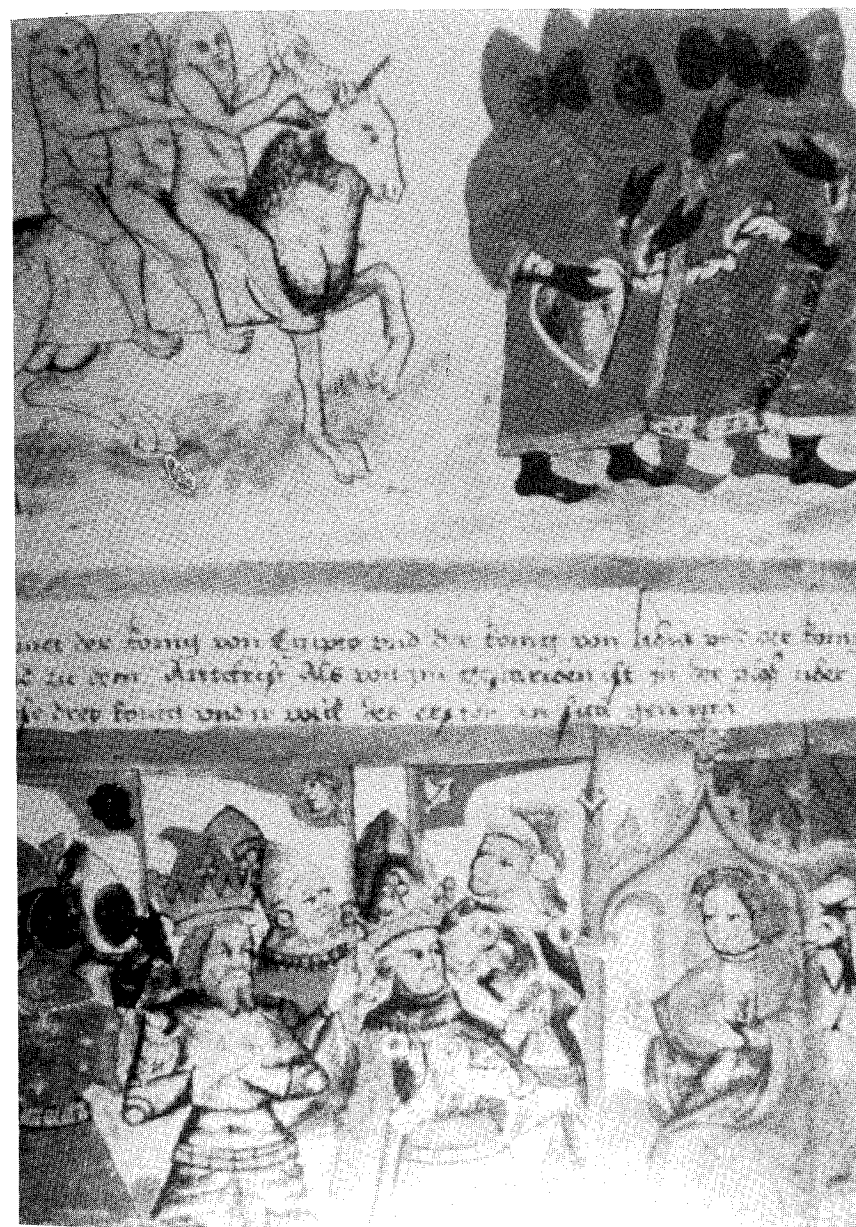

Figure 9. Detail of Black Moors marching to the anti-Christ. Propaganda work of Spanish artists. Date: 1400.

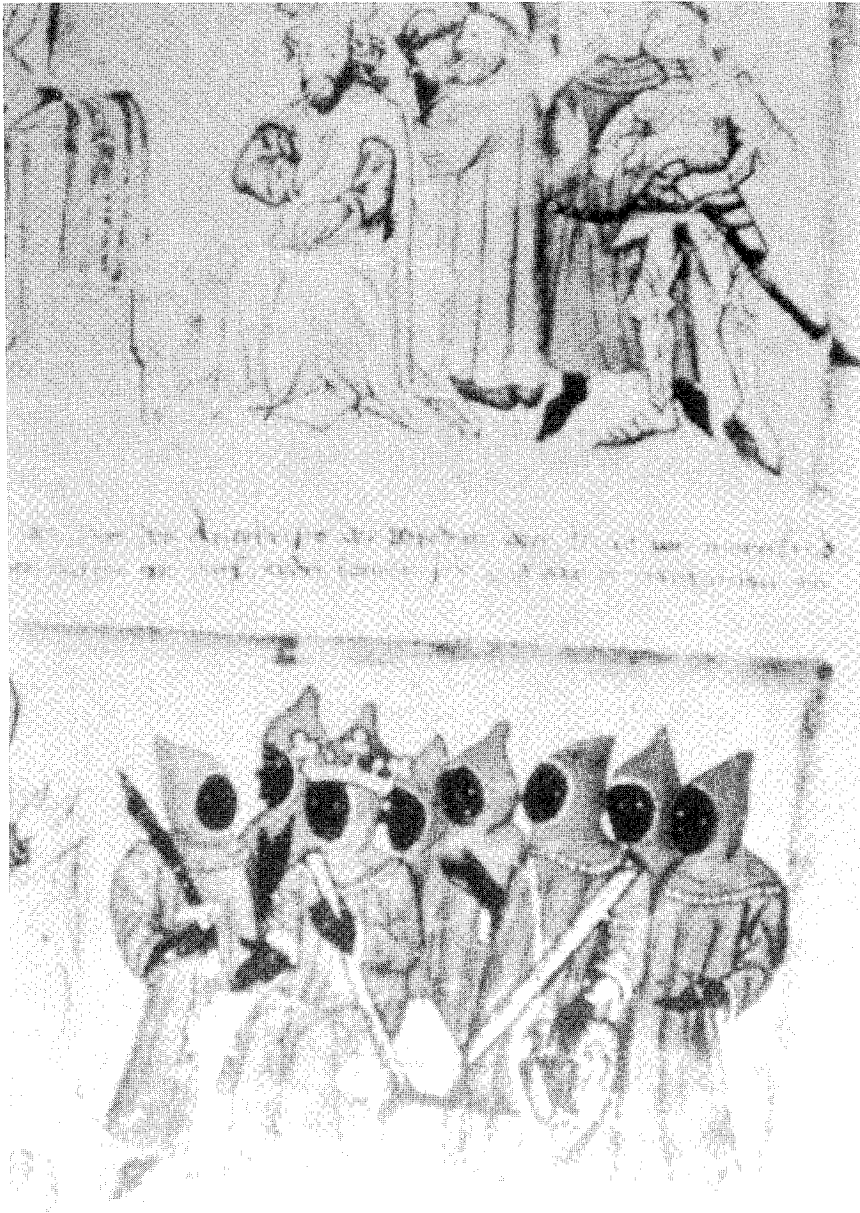
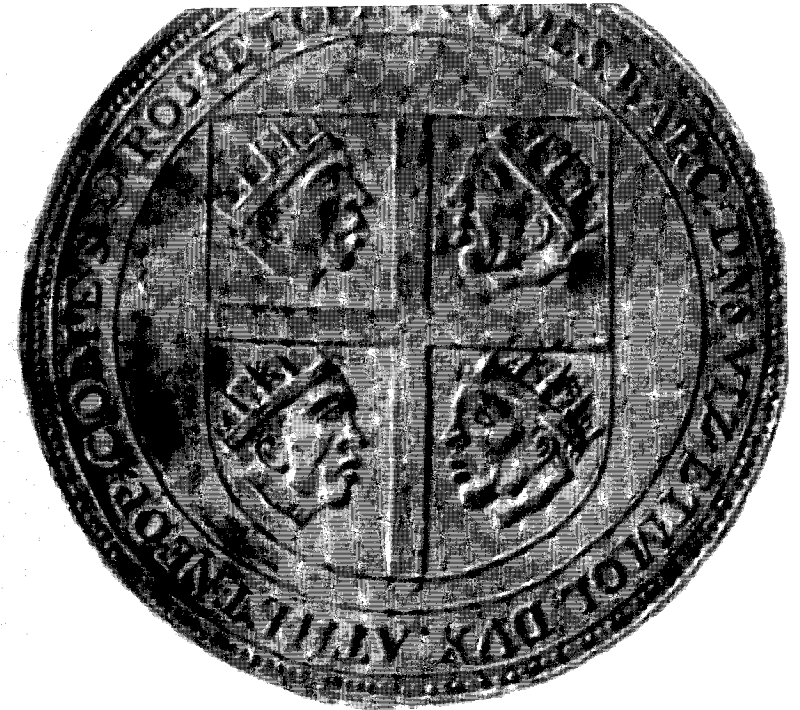

Figure 10. Detail of Black Moors and king. Date: 1400.



The original arms of the kingdom of Aragon consisted of the Christian cross, through the power of which four Moorish princes had been defeated. In the struggle for the Spanish throne after 1700, the Hapsburg King Charles placed these arms on the reverse of his

Figure 11. Black Moorish princes. Based on a model done in 1289. Date: 1700.

they have their heads shaven, leaving only a topknot, they are on a pilgrimage and they are armed with Turkish bows."²³ According to the text:

King Bucar ordered that black Moorish woman to encamp nearest to the town with all her company.... That Moorish woman was so shrewd a master archer with the Turkish bow that it was a wonder to behold, and for that reason (the History) says that the Moors called her in Arabic *nugaymath turquia*, which means 'star of the archers of Turkey.'²⁴

Far from being primitive savages, the accumulated evidence points to industry, commerce, and technical proficiency amongst the ancient Berbers. Among the products introduced by them into Spain were olives, wheat, figs, amergis, and saffron. Dyes and garments from North Africa were also highly prized. These North Africans engaged in the mining of silver and iron, and traded in gold and coral with the Sudan.

The Term Saracen

While many scholars generally agree that the word *Saracen* is of Afro-Asiatic origin, it is "far from certain" that it means "Easterner."²⁵ The general belief is that "the Saracens were originally nomadic tribes of the Arabian and Syrian deserts, early known as peoples who attacked the borders of the Roman Empire."²⁶ Pliny the Elder, or Pliny the Naturalist (23–79 A.D.) appears to have been the earliest author to mention the Saracens as a group of people.²⁷ St. Jerome (ca. 375), in his *Commentario-rum in Esaiam*, identified a people in Western Asia known as the *Agareni* (Hagarens, descendants of Hagar the Egyptian) "who are now called Saracens, taking themselves the name Sara."²⁸ German theologian, Rabanus Maurus (776–856) made similar observations. In his *Commentaria in Genesim*, Maurus connected the Moors typologically with the house of Ishmael.²⁹ It is significant to note that an early Medieval kingdom located in the Mesopotamian delta was called *Karacen*. It was known to the Byzantine Greeks as *Saracenos*.³⁰ According to French historian Jean-Paul Clebert, "Kara (which means Black) linguistically evolved into *Sarakenos*, *Saracin*."³¹

"The Medieval Spanish painter," says French art historian, Jean Devisse, "associated the color black with the Saracens."³² Dorothee Mitlitzki, however, stresses that "The people who contributed to the formation of what, in the Middle Ages, was known as Saracen culture, were of the most varied ethnic origins."³³ Saracens served a crucial public role, states Mitlitzki—political, military, and religious—and what is fanciful in them is emphasized for the purposes of patriotism, propaganda and entertainment.³⁴ It is in this context that the prominent position of confrontation between Christian knights and mighty (even gigantic) Black Saracen warriors, emerges.

The Song of Roland

The *Song of Roland* (ca. 1100), the celebrated medieval epic poem, chronicles the eighth century Frankish invasion of northern Spain, and describes the Saracens in detail. Sir Roland (the epic's hero) was allegedly the Prefect of Brittany and a champion and gallant warrior in the army of the Carolingian emperor Charlemagne. Roland is said to have perished while defending the rear-guard of the Frankish army during the Battle of Roncesvalles on August 15, 778.

As noted by H.T. Norris, "The *Song of Roland* is particularly harsh in its abuse and racial hatred."³⁵ The epic is alternately laced with contrasting images of the Saracens as vile and repulsive, dashing, lady-killing, beautifully arrayed in battle and envied for their magnificent Arabian steeds. Fortunately, from Roland's epic encounter with the Saracens we have an important window from which we can view both the pronounced Africoid element in the Saracen ranks and Christian Europe's sharp reaction to it. Sighting the Saracen army, Sir Roland declares that:

At their head rides the Saracen Abisme [Abyssinian?]: no worse criminal rides in that company, stained with the marks of his crimes and great treasons, lacking the faith in God, Saint Mary's son. *And he is black, as black as melted pitch ...*³⁶

In addition, the epic speaks of:

Ethiope, a cursed land indeed; The blackamoors from there are in his keep, Broad in the nose they are and flat in ear, Fifty thousand and more in company.³⁷

And then, to further highlight the racial identity of the army facing Roland:

When Roland sees that unbelieving race, those hordes and hordes blacker than the blackest ink—no shred of white on them except their teeth ...³⁸

In an Italian palace in Treviso, dated to the late fourteenth century, there are vivid frescoes of the *Song of Roland*. One of these frescoes portrays the conversion and baptism of Otuel the Saracen, who is painted with black skin.³⁹

Black Saracens: Giants and Mighty Warriors

Representations of Black Saracen giants in medieval literature begin with Vernagu—found in the *Pseudo-Turpin Chronicle of Charlemagne*. Dated to the early fourteenth century, the *Rouland and Vernagu* describes a duel between the "black as pitch" Saracen—Vernagu, and the Christian knight Roland. Another towering figure was Alagolfare—the Ethiopian giant of the



Figure 12. Ysore, the Black “Saracen” giant. Date: 1250.

Sowdone of Babylone, whose “skin was black and hard.”⁴⁰ It is said that:

This Astrogot (Alagolfare) of Ethiopia/ he was a king of great strength;
There was none such in Europe. So strong and so long in length/ I trowe
(?) he were a devil’s son of Bezelbubb’s line.⁴¹

There is also the legendary fight between William of Orange (an eleventh century count of Poitiers) and Ysore (a Black Saracen giant). The portrayals of Black Saracen giants in medieval literature thus reflects the realistic associations of “tall Africans in Saracen armies.”⁴²

Blacks likewise appear as sea-roving Saracens in the early Viking sagas. For example, in the *Orkneyinga Saga* (a thirteenth century Icelandic account of the Earls of Orkney), references are made to a great battle on the Mediterranean Sea between Vikings and Black Saracens. It is stated that:

Once both parties were aboard there was fierce fighting, the people on the dromond being Saracens, whom we call infidels of Mohammed, among them a good many black men, who put up a strong resistance.⁴³

The fighting qualities of the Black Saracens must have been quite striking to the Earl of Orkney, who wrote:

Erling, honored aimer of spears, eagerly advanced toward the vessel in victory, with banners of blood; *the black warriors*, brave lads, we captured or killed, crimsoning our blades. Busy with this dromond business our blades we bloodied on the blacks ...⁴⁴

After sparing some of the captives, including their leader, these Vikings fell into the hands of more Saracens, “who repaid them with similar generosity.”⁴⁵

Moorish Militarism

The discussion of Moorish militarism begins distinctly with the ancient martial conflicts between Rome and Carthage. Moorish soldiers are mentioned as early as the expedition to Sicily in 406 B.C., in a revolt by a certain Hanno (circa 350 B.C.) and the Roman invasion of Africa in 256 B.C.⁴⁶ They are similarly mentioned in Livy’s account of the second Punic War (218–201 B.C.)⁴⁷ In their bitter, prolonged and increasingly desperate struggle for national independence and control of the western Mediterranean, the Carthaginians utilized Moorish troops as integral elements in all of their battle campaigns. With the Numidians, the Moors fought on the side of the Carthaginians against the Romans. These redoubtable Moorish warriors greatly aided the Carthaginians, and were particularly beneficial to Hannibal Barca—the illustrious African general. Indeed, Hannibal, “who had over 6,000 [Moors] at his disposal, suffered his only defeat when they were no longer available.”⁴⁸



Figure 13. Black Moors with King Agolant attacking Christian fortress (related to the *Song of Roland* theme). Date: 1350.

Nevertheless, with the destruction of Carthage in the third Punic War (150–146 B.C.), Rome became the supreme power in North Africa. In spite of Roman dominance, however, regional and national independence movements continued unceasingly. Unfortunately, because of the many North African revolts against Roman authority, historians tend to mention only those that were of exceptional violence and intensity. One such rising, known as the Jugurthine War (112–105 B.C.), was initiated by the nationalist fervor of the North African patriot Jugurtha. Directing an unrelenting guerrilla war, Jugurtha became a formidable adversary to his enemies, inflicting embarrassing defeats upon the Roman legions. “The wars of Jugurtha,” writes Graham Webster, “demonstrated the value of the nimble Moorish horsemen who Trajan later found so useful against the Dacians.”⁴⁹

During the Dacian Wars of eastern Europe (101–105), the Roman military relied heavily upon highly mobile units of Moorish cavalry. On a Roman column dedicated to the wars of Trajan in Dacia, there is a special relief devoted to a large body of galloping horsemen easily recognizable as Moors. They are depicted with tiered and plaited rows of curled hair, short tunics, saddleless with only a single bridle. Another work dated to the same period is a terracotta human head found in the Dacian city of Suicidava. Described by archaeologists as the head of a “Negro or Moor,” it is in many respects similar to the horse cavalry depicted on the Roman column.

Black soldiers, specifically identified as Moors, were actively recruited by Rome and served tours of duty in Britain, France, Switzerland, Austria, Hungary, Poland, Romania, etc.

An original brass military diploma which dates from the middle of the second century A.D. mentions Moorish soldiers in Moesia, which is modern Serbia. Another military diploma of A.D. 158 speaks of Moorish soldiers from Africa in Dacia, or modern Rumania, and also of auxiliary troops of the Dacian Moors. A Roman document, *Notitia Dignitatum*, which dates from the beginning of the fifth century A.D., mentions several Moorish battalions in the Balkans and the Moorish military colony *Ad Mauros* which was located on the Inn River near Vienna; and in what is modern Besarabia, there was a city called Maurocastrum. According to the document *Notitia Dignitatum*, 2500 to 5000 Illyrian Moorish soldiers, in five separate military units, had served in the Near East. From this document we must deduce that at the beginning of the fifth century at least 100,000 descendants of Moors lived in Illyricum, which was located in the present-day Balkans.⁵⁰

Regarding specific military men of Moorish extraction, there were several that served Rome honorably, or had ancestors that participated in Rome’s foreign wars. In 253, for example, “After his departure, the governor of Lower Moesia (modern Serbia), M. Aemilius Aemilianus, a Moor born in Mauretania, succeeded in defeating the Goths and was proclaimed emperor by his troops.”⁵¹ In another case, Zenophilus, Consul of Numidia, boasts that

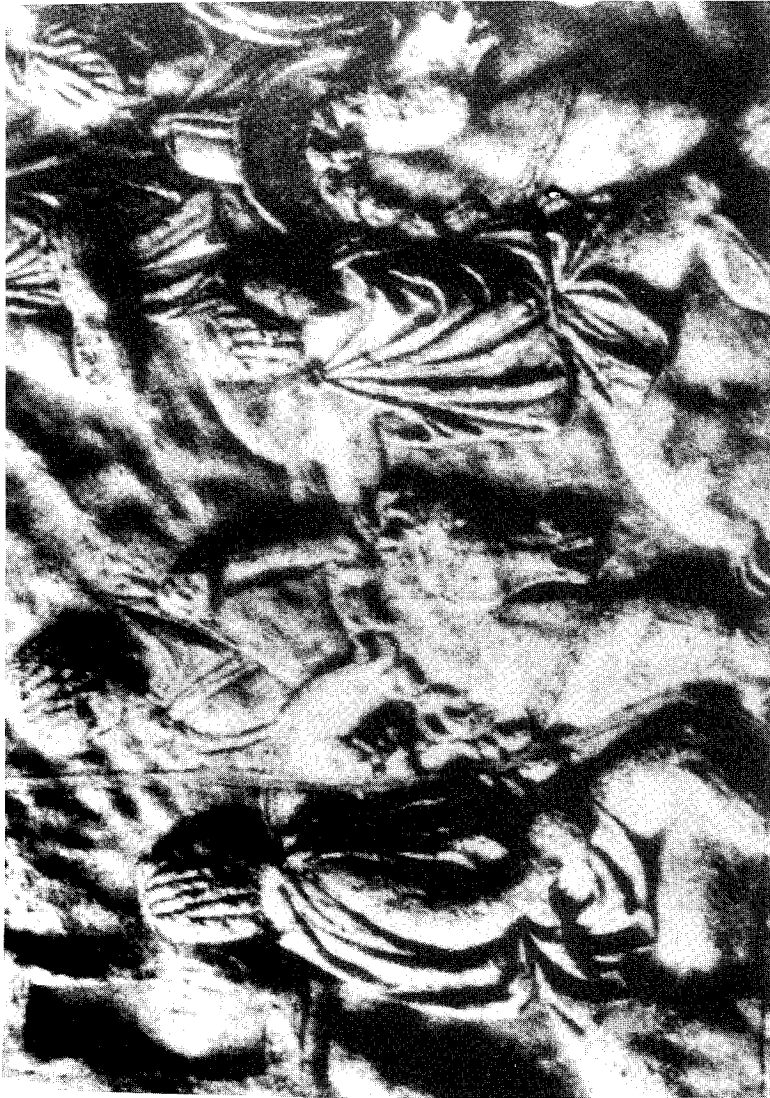

Figure 14. Detail of Moorish cavalry in the army of Trajan (Roman general). Note the curled hair style which is seen in ancient Nubia and Egypt. Date: 2nd century.

“My grandfather is a soldier, he had served in the *Commitatus*, for our family is of Moorish origin.”⁵² To the *Commitatus* belonged the renowned *Equites Mauri*, a Black horse cavalry of North Africa.

The Moors Before the Invasion of Spain

We should not lose sight of the fact that connections between North Africa and Spain were in existence centuries before the birth of Muhammad. It would not even be presumptuous to suggest that very early blood ties may have connected the regions. The fact that Blacks had lived in some of the same Iberian regions later occupied by Islamic Moors suggests this. For example, the city of Osuna, in southern Spain, has yielded several archaeological works depicting Blacks with tightly curled hair which archaeologists have labeled “Negroid.” As long ago as 170, writes Durant, “the Mauri or Moors invaded Spain from Africa.”⁵³ Even earlier, according to Laroui, “The Berbers of that region [North Africa] made incursions into Baetica, Spain.”⁵⁴ But the use of the term “Berber” perhaps camouflages the issue here. Regarding the same event, W.T. Arnold speaks of “Moorish incursions in Baetica as early as the first century.”⁵⁵ Interestingly enough, many of these Moors were Christians.

During the sixth century, the Byzantine historian Procopius and the Latin poet Corippus compiled precious documents regarding the Moors in post-Roman North Africa. During this period the dominance of the Vandals, the Germanic tribes who had invaded North Africa in 429 and seized several provinces (including Mauretania), was challenged politically and militarily. In providing a veritable war correspondent’s view, Procopius chronicled the ferocious assaults and ultimate victories of the Moorish rebels. This is recorded in his volume, appropriately entitled *The Wars*:

When the Moors wrested Aurasium from the Vandals, not a single enemy had until now ever come there or so much as caused the barbarians to be afraid that they would come.... And the Moors of that place also held the land west of Aurasium, a tract both extensive and fertile. And beyond these dwelt other nations of the Moors, who were ruled by Ortaias.⁵⁶

This statement shows that the Moors were not only perceived by Procopius as numerically significant, but demonstrates that they occupied an extensive portion of northwest Africa.

During this same period Byzantine arms began moving into Africa. With them came strong efforts to renew the grip of Roman dominance. The emperor Justinian sent in General Johannes Troglita to quell the challenge to Byzantine authority, but was forced to face a full-scale war. There was a great slaughter and taking of prisoners, as recounted by Corippus in the military epic *Iohannis*. Corippus recorded not only the slaying of several Moorish



Figure 15. Moorish head found at Suicidava (modern Romania). Date: 2nd century.

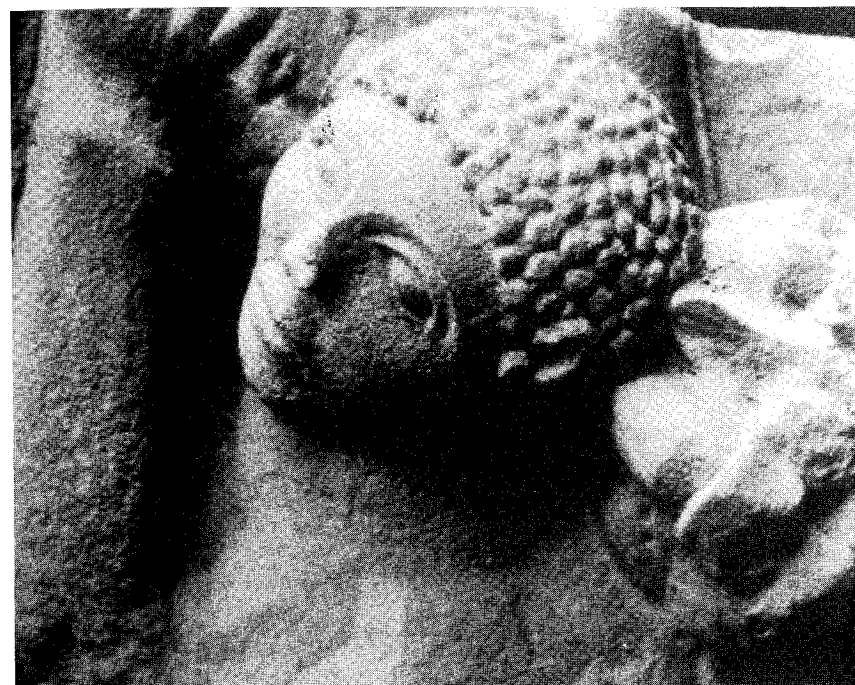

Figure 16. Africoid type from Osuna, Spain. Date: Punic period.



Figure 17. Africoid type from Osuna, Spain. Date: Punic period.

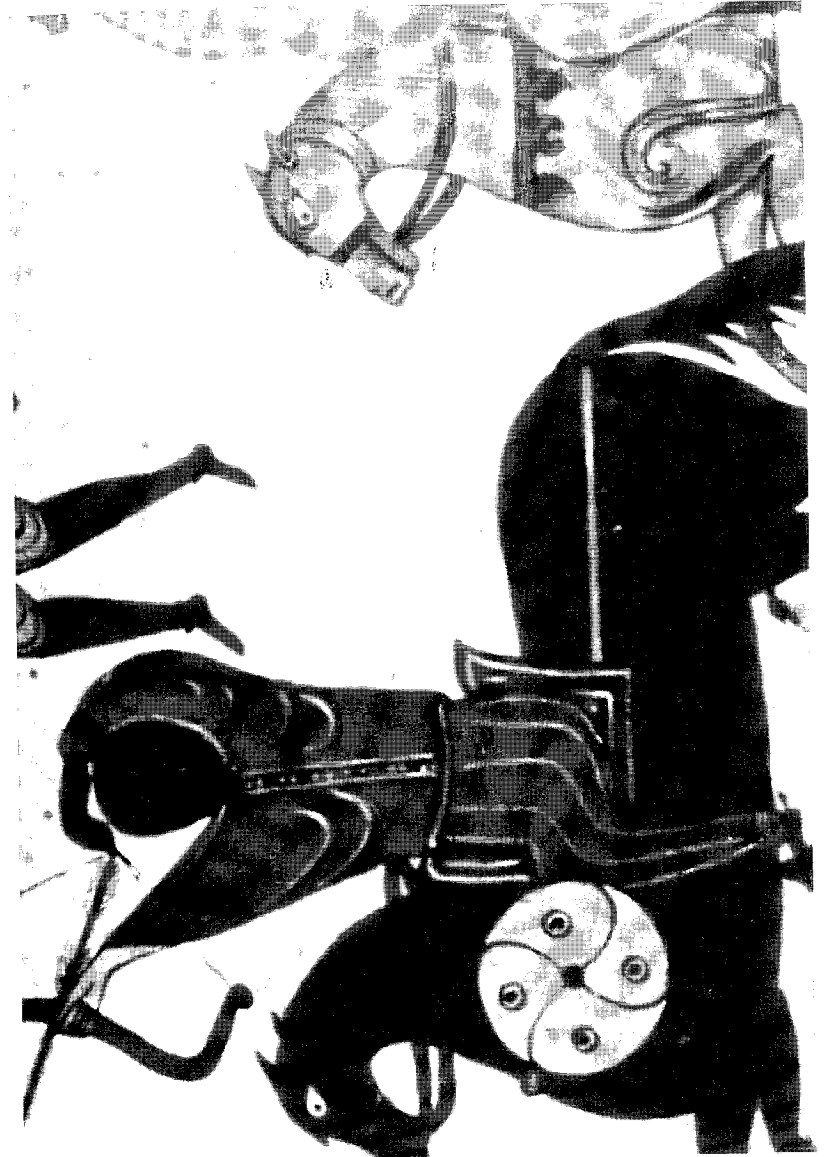

Figure 18. Black Christian soldier of Spain fighting invading Moors of 710-711. Date: 1150.

chieftains, he also mentioned a number of captives that were as “black as crows.”⁵⁷ One Moorish ruler, however, Garmul (king of Mauretania), engineered the crushing of the Byzantine army in 571. Such events established the situation in North Africa prior to the Arab invasions late in the seventh century.

The Moorish Conquest of Spain

Early in the eighth century, after a grim and extended resistance to the Arab invasions of North Africa, the Moors joined the triumphant surge of Islam. Following this, they crossed over to the Iberian peninsula where their swift victories and remarkable feats soon became the substance of legends. The man chosen to lead the probe into Iberia was Tarif, son of Zar’a ibn Abi Mudrik. Tarif was one of the young generation of Islamized Berbers imbued with the military thinking of Hassan ibn al-Nu’man and Musa ibn Nusayr — the two men who had just commanded the Arab conquest of northwest Africa. In July 710, Tarif, with four-hundred foot soldiers and one-hundred horse, all Berbers, successfully carried out a reconnaissance mission in southern Iberia. Tarifa, a small port in southern Spain, is named after him.

It is clear, however, that the conquest of Spain was undertaken upon the initiative of Tarik ibn Ziyad. Tarik ibn Ziyad ibn ‘Abd Allah ibn Walghu was a member of the Warfadjuma branch of the Nafza Berbers. Musa ibn Nusayr had previously appointed him governor of the far western Maghrib, which covered what is today the southern part of the kingdom of Morocco. Tarik was in command of an army of at least 10,000 men, mainly Sanhadja Berbers.

In 711, with a Berber expeditionary force and a small number of Arab translators and propagandists (some say three-hundred), Tarik crossed the straits and disembarked near a rocky promontory which from that day since has born his name: Djabal Tarik (Tarik’s mountain), or, Gibraltar. In August 711, he won a decisive victory over the Visigoth army. It was during this conflict that Roderick (the last Visigoth king) was killed. On the eve of the battle, Tarik is alleged to have roused his troops with the following words: “My brethren, the enemy is before you, the sea is behind; whither would ye fly? Follow your general: I am resolved either to lose my life or to trample on the prostrate king of the Romans.”⁵⁸

Wasting no time to relish his victory, Tarik pushed on with his seemingly tireless Berber cavalry to Toledo and seized the Visigoth capital. Within a month’s time, Tarik ibn Ziyad had effectively terminated Visigothic dominance of the Iberian peninsula.

Musa ibn Nusayr joined Tarik in Spain, and helped complete the conquest of Iberia with an army of 18,000 Arab and Berber troops. The two commanders met at Talavera. Here, Tarik and his Berbers were given the task of subduing the northwest of Spain. With vigor and speed they set about their

mission, and within three months they had swept the entire territory north of the Ebro River as far as the Pyrenees, and annexed the turbulent Basque country. There they left a small detachment of men under Munusa, a Berber lieutenant who was later to play a decisive role in the Muslim campaigns in southern France.

In the aftermath of these brilliant struggles, Berbers by the thousand flooded into the Iberian peninsula. So eager were they to come that some are said to have floated over on tree-trunks. Tarik himself, at the conclusion of his illustrious military career, retired to the distant East, we are informed, to spread the teachings of Islam.

While many modern historians refer to Tarik’s garrison as Berbers and Arabs, primary sources, such as Ibn Husayn (ca. 950), recorded that these troops were “Sudanese,” an Arabic word for Black people.⁵⁹ Arab writers Ibn Hayyans and Ibn al-Athir (1160–1234), the authors of the *Dhikr Bilad al-Andalus* and the *Akbar Majmu’a* respectively, both refer to Tarik’s invading force. The author of the *Dhikr Bilad al-Andalus* specifically refers to a force of at least seven hundred Sudanese in Tarik’s garrison. This suggests that some modern writers have attempted to place an artificial wedge between these early Berbers and Blacks.

References to these Blacks have so puzzled some modern scholars that there have been vain attempts to explain away and discredit their very existence. For example, Norris writes:

When some of the accounts tell of Negroes in Tarik’s army, that army which ascended the Rock of Gibraltar with its pack beasts, built a wall for defense and mastered the plain of Algeciras, then it is improbable that they were Nubians or Ethiopians.⁶⁰

In discussing the status of these Blacks, Taha suggests that they were probably slaves.⁶¹ An Arab legend describes these Blacks as pseudo-cannibals: “The Sudanese (Blacks) took captive some of the Goths. They slew them and *pretended* to eat them and this added to the fear and terror of them.”⁶² There is really no need to speculate on the ethnicity of these early invaders of the conquest period. Primary Christian sources relating to the conquest, particularly the *Primera Cronica General* of Alfonso X, make the following observation on the Moors: “Their faces were as black as pitch, the handsomest amongst them was as black as a cooking pot.”⁶³

With the conquest and settlement of Spain, the Arabs developed patterns of racial bias towards the Berbers. This bias, sometimes blatant and other times more subtle, manifested itself in various ways, including disproportionate tax assessments and poor land allotments. For example, after founding the Almohad dynasty, the Berber ruler *Abd al-Mu’min* offered the Granadan post of “able secretary” to an Arab poet named Abu Ga’far. Scheduled to work with al-Mu’min’s son, Abu Said, the Arab poet hesitated “because the dark-skinned

Berber seemed to him far below his own intellectual standards."⁶⁴ This kind of attitude often led to hostile feelings, open rebellions, and shifting alliances between the Arab, Berber, and Christian factions of the Iberian peninsula.

In the ninth century, in order to achieve commercial dominance in the region, Muslim powers in Tunisia launched an invasion of Sicily. The conquest was facilitated by "large and well organized fleets" coming from the east coast of Spain and the western Maghrib, and manned chiefly by Berbers. It began in 827, and ended ten years later with the storming of Palermo. The occupation of Palermo was followed by the occupation of Messina in 842 and Syracuse in 878. In 937, Ibn Hawkal noted that Blacks were very common in Palermo. Regarding one of the city's main entrances, Hawkal wrote that it was called the "Bab es Soudan," or "Gate of the Blacks," so named after its ebony-hued residents.⁶⁵ Pope Leo III referred to these Blacks variously as Moors, Agareni, and Saracens.⁶⁶

Islamic encroachment on the European mainland took place around 846, when "Saracens" landed at the mouth of the Tiber River and besieged Rome. Of this invasion, the German historian Hincmar (ca. 875) wrote that:

The Arabs and Moors assaulted Rome on the Tiber, and when they laid waste to the basilica of the blessed Peter, the prince of the apostles, and carried off all the ornaments and treasures, with the very altar which was situated above the tomb of the famous prince of apostles, they occupied strongly a fortified hill a hundred miles from the city.⁶⁷

In the invasion of Rome, Pope John VII agreed to pay an annual tribute of 25,000 marks of silver to the Saracens to retreat.

Frederick II (1197–1250), of the Hohenstaufen dynasty, developed especially close relationships with the remaining Blacks in Sicily, and retained a Moorish chamberlain who was constantly in his presence. While admittedly breaking the Islamic powerbase, he also solicited the aid of the Moors from Palermo in his intense struggle with the papacy. After resettling conquered Muslims on the Italian mainland at Lucera, the monarch recruited an elite guard unit of 16,000 Black troops.

One of the independent sovereigns of Moorish descent with whom Frederick II came into contact was Morabit, a name whose attachment may be found with the Sanhadja Berber tribes known as *Murabit*. Growing conflicts and rebellion against the expansionist policies of Frederick II eventually led to the death of Morabit. In 1239, however, another Black man, Johannes Maurus, attained a position of considerable authority at the Hohenstaufen royal court. "In South Italy and Sicily," writes Paul Kaplan, "dark-skinned Moslems had already been visible for several centuries."⁶⁸

The Moorish Occupation of Spain

Among the most substantial Berber groups to occupy Spain were the Hawwara, Luwata, Nafza, Masmuda, Miknasa, Zanata, and Sanhadja. Before participating in the eighth century invasion of Spain, the Hawwara Berbers in Africa occupied the province of Tripolitania and the deserts of southern Tunisia. They worshipped the Libyan sun-god Amun, who was depicted as a bull or ram. After the invasion of Spain, they settled in Cordoba, and established a fortified city near Jaen. A wealthy group of Hawwara also settled in Morida and Medellin. *Abd-al-Rahman* ibn Musa al-Hawwari was a judge in Ecija during the reign of *Abd-al-Rahman* III.

The golden age of the Umayyad dynasty in Spain came during the tenth century. Under the reigns of *Abd-al-Rahman* III (912–61) and Hakam II (961–76), the Umayyad dynasty established sovereignty over the most substantial portion of the Iberian peninsula. At the pinnacle of the Umayyad dynasty the great city of Cordoba possessed 200,000 residences, 600 mosques, and 900 public baths that were patronized by all social classes. Among his many accomplishments, Hakam II added twenty-seven schools for the free instruction of the poor. It should be pointed out that, at least during this era of Islamic Spain, girls as well as boys went to school, and numerous Moorish women became prominent in the literary and artistic fields. Other Moorish women were involved in education, law, medicine and library science.

Both Tarik ibn Ziyad and *Abd-al-Rahman* I—the founder of the Umayyad dynasty in Spain in 756, are said to have belonged to the Nafza Berbers. In fact, one of the most important keys to *Abd-al-Rahman*'s success as a monarch was his recruitment, directly from Africa, of a well-trained army of more than 40,000 Berbers. Many of the Nafza settled in Spain. Rich and numerous, the Nafza Berbers of Osuna, Spain, became civic leaders, writers and theologians. The Nafza also constituted a significant part of the population of Takurunna.

The Masmuda Berbers were described as Blacks by Abu Shama in his *Kitab al-Ravdatayn*.⁶⁹ They settled in several parts of Spain, including Mawrur, Cordoba, Valencia, Guadalajara, and Santaver. Masmuda Berbers also settled in southern Portugal. Neither did wealth and prestige escape the Masmuda. The previously mentioned founder of the powerful Almohad dynasty, *Abd al-Mumin*, was a Masmuda Berber.

Al-Kahina (ca. 690), the woman who led the most determined resistance to the early Arab invasion of North Africa, was a Zanata Berber. With the invasion of Spain, many Zanatas settled near Seville, in Sidonia, Alicante, Murcia, Guadalajara, and in the region of Saragossa. The Marinids, who in 1275 invaded Spain from Morocco and defeated Christian Castile, were Zanata Berbers. Zanata is written several ways in various texts, including Zenata, Znaga and Zenaga. The Zanata used a Libyco-Berber script and spoke



Figure 19. Detail of Moorish, Arab, and Christian allies; from the *Cantigas*. Date: 1254.

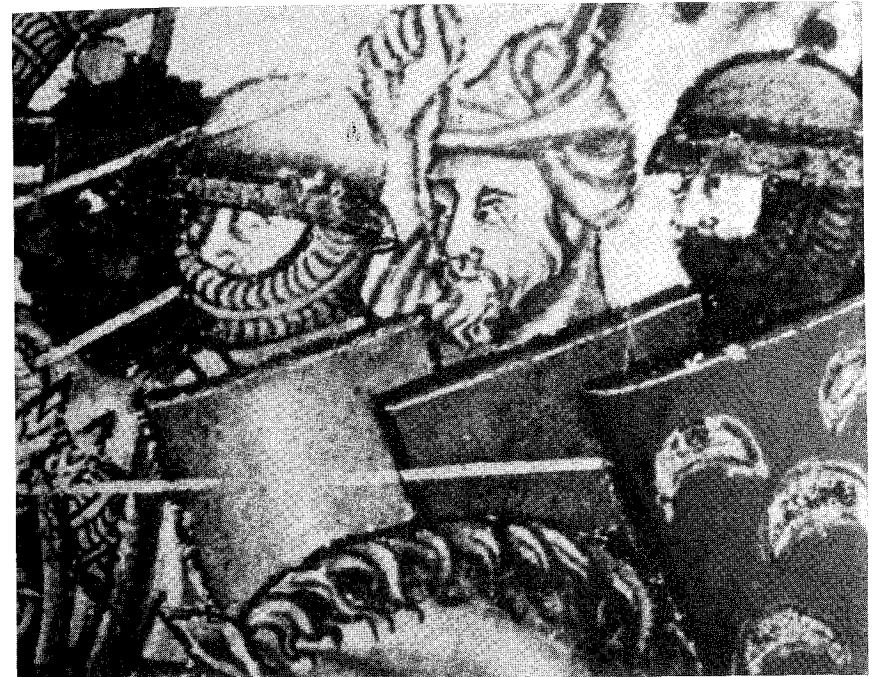

Figure 20. Detail of Moorish, Arab, and Christian allies, from the *Cantigas*. Date: 1254.



Figure 21. Moors and Arabs confronting Christians. Date: 1350.

Zenega, a Kushito-Hamitic language. This seems to be the basis for the name Senegal. The Zanata are also credited with having introduced the camel into the Maghrib.

The Sanhadja Berbers of the western Sahara were composed of both sedentary peoples and nomads. Included among the nomad Sanhadja were the Lamta and Lamtuna Berbers. The Sanhadja, known as the *Mulaththamun* (people of the veil), were responsible for the second significant Moorish invasion of *al-Andalus* (the Arabic name for Islamic Spain). In 1095, the Sanhadja Berbers initiated the Almoravid dynasty. The Almoravid dynasty was called the "Empire of the Two Shores." It lasted a hundred years and stretched from the Senegal River in West Africa to the Ebro River in northern Spain.

There has been much discussion and speculation about the Sanhadja face mufflers. In Islamic Spain the veil was considered a privilege of the true Almoravids, and its wearing was forbidden to all but the Sanhadja. It was something like a uniform or distinctive dress of the ruling class. According to Ibn Hawkal, "Since the day they were created their faces ... have never been seen, unless it be their eyes. This is because they muffle their faces when they are young and they grow up with that custom."⁷⁰

According to al-Bakri (d. 1078), there were among the Sanhadja Berbers Blacks "professing Judaism."⁷¹ These Blacks are referred to as the *Bafour*. The *Bafour* practiced Judaism before they were overcome and absorbed by the Almoravids. The *Bafour* and Sanhadja are both linked, by the way, through their association with the early rulers of the Ghanaian Empire.

A prototype of the warrior-king, both as priest and potentate, the Almoravid emperor Yusuf ibn Tashfin led veiled fighting men into *al-Andalus* beginning in 1086, at the request of the hard-pressed Muslim residents of Spain. Yusuf, a Sanhadja Berber from the Sudan, had his physical features described by the Arab chronicler al-Fasi as brown-skinned, small-framed and hook-nosed, with heavy eyebrows and woolly hair.⁷²

Among Yusuf's troops was a personal retinue of 4,000 Blacks carrying Lamti shields (covered in hippopotamus skin), peculiar bows, Yazani spears, Zabian javelins, and moving to the constant sound of drumming. "The bizarre aspect of the African army," writes Norris, "was a valuable psychological weapon."⁷³

The Black St. Maurice: Knight of the Holy Lance

The name *Maurice* is derived from Latin and means "like a Moor." The Black St. Maurice (the Knight of the Holy Lance) is regarded as the greatest patron saint of the Holy Roman Empire. The earliest version of the Maurice story and the account upon which all later versions are based, is found in the writings of Eucherius, Bishop of Lyons (ca. 450). According to Eucherius,

Maurice was a high official in the Thebaid region of Egypt—an early center of Christianity. Specifically, Maurice was the commander of a Roman legion of Christian soldiers stationed in Africa. By the decree of Roman emperor Maximian, his contingent of 6,600 men was dispatched to Gaul and ordered to suppress a Christian uprising there. Maurice disobeyed the order. Subsequently, he and almost all of his troops were martyred when they chose to die rather than persecute Christians, renounce their faith, and sacrifice to the gods of the Romans. The execution of the Theban Legion occurred in Switzerland near Aganaum (which later became Saint Maurice-en-Valais) on September 22, either in the year 280 or 300.

In the second half of the fourth century the worship of St. Maurice spread over a broad area in Switzerland, northern Italy, Burgundy, and along the Rhine. Tours, Angers, Lyons, Chalon-sur-Saone, and Dijon had churches dedicated to St. Maurice. By the epoch of Islamic Spain, the stature of St. Maurice had reached immense proportions. Charlemagne, the grandson of Charles Martel and the most distinguished representative of the Carolingian dynasty, attributed to St. Maurice the virtues of the perfect Christian warrior. In token of victory, Charlemagne had the Lance of St. Maurice (a replica of the holy lance reputed to have pierced the side of Christ) carried before the Frankish army. Like the general populace, which strongly relied on St. Maurice for intercession, the Carolingian dynasty prayed to this military saint for the strength to resist and overcome attacks by enemy forces.

In 962, Otto I chose Maurice as the title patron of the archbishopric of Magdeburg, Germany. By 1000 C.E. the worship of Maurice was only rivalled by St. George and St. Michael. After the second half of the twelfth century, the emperors were appointed by the pope in front of the altar of St. Maurice, in St. Peter's Cathedral in Rome.

In Halle, Germany, a monastery with a school attached to it was founded and dedicated to St. Maurice in 1184. In 1240, a splendid Africoid statue of St. Maurice was placed in the majestic cathedral of Magdeburg. The facial characteristics of the statue are described as follows:

The relatively small opening in the closely fitting mail coif was sufficient for the Magdeburg sculptor to produce a convincing characterization of St. Maurice as an African. The facial proportions show typical alterations in comparison with European physiognomy. The broad, rounded contours of the nose are recognizable although the tip has been broken off.

The African features are emphasized by the surviving remains of the old polychromy. *The skin is colored bluish black*, the lips are red, and the dark pupils stand out clearly against the white of the eyeballs. The golden chain mail of the coif serves, in turn, to form a sharp contrast with the dark face.⁷⁴

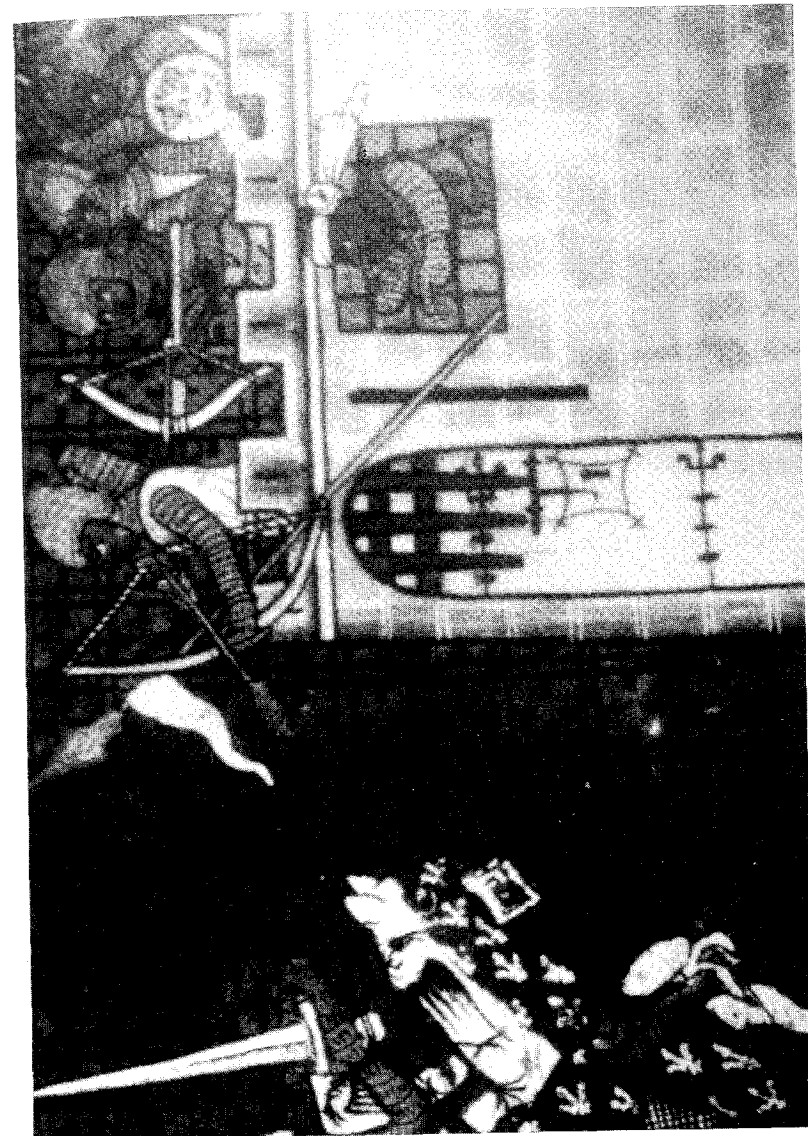

Figure 22. Detail of depiction of Kingdom of Agen defended by Moors against Charlemagne. Date: 1335.



Figure 23. Detail of conquest of Majorca, Spain. Note Black Moor and flag with so-called Star of David. Date: 1250.

A center of extreme devotion to St. Maurice was developed in the Baltic states, where merchants in Tallin and Riga adopted his iconography. The House of the Black Heads of Riga, for instance, possessed a polychromed wooden statuette of St. Maurice. Their seal bore the distinct image of a Moor's head.

In 1479, Ernest built several castles, one of which he named after St. Maurice – the Moritzburg. Under a banner emblazoned with the image of a Black St. Maurice, the political and religious leaders of the Holy Roman Empire battled the Slavs. The cult of St. Maurice reached its most lavish heights under Cardinal Albert of Brandenburg (1490–1545), who established a pilgrimage at Halle in honor of the Black saint. Between 1523 and 1540, people from throughout the empire journeyed to Halle to worship the relics of St. Maurice.

The existence of nearly three hundred major images of the Black St. Maurice have been catalogued, and even today the veneration of St. Maurice remains alive in numerous cathedrals in eastern Germany.

Sir Morien: Black Knight

Few documents portray the ethnicity of the Moors in medieval Europe with more passion, boldness and clarity than *Morien*. *Morien* is a metrical romance rendered into English prose from the medieval Dutch version of the *Lancelot*. In the *Lancelot*, it occupies more than five thousand lines and forms the ending of the first extant volume of that compilation. Neither the date of the original poem or the name of the author is known. The Dutch manuscript is dated to the beginning of the fourteenth century. The whole work is a translation, and apparently a very faithful translation, of a French original. It is quite clear that the Dutch compiler understood his text well, and though possibly somewhat fettered by the requirement of turning prose into verse, he renders it with uncommon fidelity.

Morien is the adventure of a splendidly heroic Moorish knight (possibly a Christian convert), supposed to have lived during the days of King Arthur and the Knights of the Round Table. *Morien* is described as follows:

*He was all black, even as I tell ye: his head, his body, and his hands were all black, saving only his teeth. His shield and his armour were even those of a Moor, and black as a raven.*⁷⁵

Initially in the adventure, *Morien* is simply called “the Moor.” He first challenges, then battles, and finally wins the unqualified respect and admiration of Sir Lancelot. In addition, *Morien* is extremely forthright and articulate. Sir Gawain, whose life was saved on the battlefield by Sir *Morien*,⁷⁶ is stated to have “harkened, and smiled at the black knight’s speech.”⁷⁷ It is noted that *Morien* was as “black as pitch; that was the fashion of his land—*Moors are*

black as burnt brands. But in all that men would praise in a knight was he fair, after his kind. Though *he were black*, what was he the worse?"⁷⁸ And again: "his teeth were white as chalk, otherwise was he altogether black."⁷⁹

"Morien, who was black of face and limb"⁸⁰ was a great warrior, and it is said that: "His blows were so mighty; did a spear fly towards him, to harm him, it troubled him no whit, but he smote it in twain as if it were a reed; naught might endure before him."⁸¹ Ultimately, and ironically, Morien came to personify all of the finest virtues of the knights of medieval Europe.

According to Gerald Massey, "Morion is said to have been the architect of Stonehenge.... Now, as a negro is still known as a Morien in English, may not this indicate that Morien belonged to the black race, the Kushite builders?"⁸² "It should be noted that for a very long period the Dutch language used *Moor* and *Moriaan* for Black Africans."⁸³ Among the Lorma community in modern Liberia, the name *Moryan* is still prominent.

The Expulsion from Spain and the Dispersal of the Moors

In Iberia, Christian pressures on the Moors grew irresistible. Finally, in 1492, Granada, the last important Muslim stronghold in al-Andalus, was taken by the soldiers of King Ferdinand and Queen Isabella, and the Moors were expelled from Spain. In 1496, to appease Isabella, King Manuel of Portugal announced a royal decree banishing the Moors from that portion of the peninsula. The Spanish king Philip III expelled the remaining Moors by a special decree issued in 1609. Fully 3,500,000 Moors, or Moriscos, as their descendants were called, left Spain between 1492 and 1610.

Over a million Moors settled in France. Others moved into Holland. A very curious story in the Netherlands is that of *Zwarte Piet* (Black Peter). By some accounts *Zwarte Piet*, the companion to *Sinterklaas* (Santa Claus), was a Moorish orphan boy whom *Sinterklaas* adopted and trained as his assistant.⁸⁴

By 1507, there were numerous Moors at the court of King James IV of Scotland. One of them was called "Helenor in the Court Accounts, possibly Ellen More, who reached Edinburgh by way of the port of Leith and acted a principal role in 'the tournament of the black knight and the black lady,' in which the king of Scotland played the part of the black knight."⁸⁵ There were at least two other Black women of the royal court who held positions of some status, and they are stated as having had maidservants dress them in expensive gowns.⁸⁶ There is also a reference, in 1569, to the payment of clothes for *Nageir the Moor*.⁸⁷

In 1596, Queen Elizabeth, highly distressed at the growing Moorish presence in England, wrote to the lord mayors of the major cities that "there are of late divers blakamores brought into this realm, of which kinde of people there are already too manie, considering howe God hath blessed this land with great increase of people of our nation as anie countrie in the world." Her

instructions were that "these kind of people should be sent forth from the land." She repeated this later in the year saying that "these kind of people may be well spared in this realme, being so populous."⁸⁸

Appendix: *The African Presence in Early Arabia*

A summary account of the Moors in antiquity would be incomplete without at least a brief overview of the African presence in early Arabia. The Arabian peninsula, first inhabited more than 8,000 years ago, was early populated by Blacks. Once dominant over the entire peninsula, the African presence in early Arabia is most clearly traceable through the Sabeans. The Sabeans were the first Arabians to step firmly within the realm of civilization. The southwestern corner of the peninsula was their early home. This area, which was known to the Romans as *Arabia Felix*, is today called Yemen.¹ In antiquity this region gave rise to a high degree of civilization because of the fertility of the soil, the growth of frankincense and myrrh, and the close proximity to the sea and consequently its importance in the trade routes. The Sabeans have even been called "the Phoenicians of the southern seas."

We hear of the Sabeans in the tenth century B.C. through the fabled exploits of its semi-legendary queen. This woman had all the qualities of an exceptional monarch, and appears to have ruled over a wealthy domain embracing parts of both Africa and Arabia. She is known as *Bilqis* in the Koran, *Makeda* in the *Kebr Negast*, and the Queen of Sheba in the Bible. The three of these documents provide a relatively clear picture of a highly developed state distinguished by the pronounced overall status of women. *Bilqis/Makeda* was not an isolated phenomenon. Several times, in fact, do we hear of prominent women in Arabian history; the documents they are mentioned in providing no commentary on husbands, consorts, or male relatives. Either their deeds or inheritance, perhaps both, enabled them to stand out quite singularly. The Sabeans apparently possessed a dedicated matrifocal culture and society.

Around the beginning of the first millennium B.C., the period in which *Bilqis/Makeda* is thought to have lived, we find the emergence of a number of large urban centers characterized by elaborate irrigation systems. With the domestication of the camel, the southern Arabians could effectively exploit the region's greatest natural resources — frankincense and myrrh — which from the earliest historical periods were much prized and sought after. The purest and most abundant sources of frankincense and myrrh were in southern Arabia and Somalia (*Punt?*), just across the Red Sea.²

We hear of the Sabeans during the reign of the powerful Assyrian king Sargon II (721–705 B.C.). In a series of inscriptions detailing Assyrian military successes, there is specific mention of:

Pir'u, the king of Musru, Samsi, the queen of Arabia, It'amra, the Sabean,—the(se) are the kings of the seashore and from the desert—I received as their presents gold in the form of dust, precious stones, ivory, ebony-seeds, all kind of aromatic substances, horses (and) camels.³

It was during the seventh century B.C. that the Sabean rulers became known as *mukarribs* (priest-kings). This new form of government may well represent the accelerating Semitization of Arabia. The earliest known Sabean construction projects, including the mighty Marib Dam (South Arabia's most enduring technical achievement) were initiated during this period. Two mukarribs, Sumuhu'alay Yanaf and Yithi'amara Bayyim, cut deep water-courses through the solid rock at the south end of the site. The Marib Dam, which served its builders and their descendants for more than a thousand years, was traditionally believed to have been conceived by Lokman, the sage and multi-genius of pre-Islamic South Arabia.⁴ In effect, the Dam was an earthen ridge stretching slightly more than 1700 feet across a prominent wadi. Both sides sloped sharply upward, with the Dam's upstream side fortified by small pebbles established in mortar. The Marib Dam was rebuilt several times by piling more earth and stone onto the existing structure. The last recorded height of the Marib Dam was slightly more than forty-five feet.

Although the Marib Dam has now practically disappeared, the huge sluice gates built into the rocky walls of the wadi are very well preserved. They continue to stand as silent but effective witnesses to the creative genius of the South Arabian people. When the periodic but powerful rains did come, the mechanism divided the onrushing waters into two channels, which ultimately sustained the area's inhabitants. Such was the force generated by the turbulent waters, however, that the Marib Dam was periodically washed out. Reconstruction was a formidable task. In one such operation 20,000 workmen were employed, some of them coming from hundreds of miles away.

At some point during this period, perhaps even earlier, there is evidence of South Arabian settlement in Ethiopia's Tigre province. The remains of actual South Arabian settlements have been found principally at Yeha, Matara, and Haoulti. The resulting co-mingling of Ethiopian and Sabean cultures led to the development of the powerful African kingdom of Axum. The earliest Ethiopian alphabet is of a South Arabian type. The Axumite script itself is apparently a derivative of Sabean. Even the name Abyssinia is thought to have been taken from the *Habashan*, a powerful southwestern Arabian family that eventually settled in Africa. From this period Ethiopia became known in Arabic scripts as *Habashat*, and its citizens *Habshi*. This early Ethiopian-Sabean era, beginning during the early fifth century B.C., lasted a century.

As the scepter of South Arabian supremacy passed from Saba's grasp, and also Ma'in (an early rival of Saba and apparently governed by a grand council), Qataban (another regional state) emerged as the area's foremost power. Timna, one of the more archaeologically explored sites in South

Arabia, was Qataban's capital and its major urban center. Qataban reached its zenith around 60 B.C., and right afterwards went into a period of rapid eclipse. The power in South Arabia then shifted back towards Saba, in the west, albeit in a lesser form, and Hadramaut in the east, which occupied and destroyed Timna. The kingdom of Ausan, a lesser known state, also became distinct at this time. Ausan had such extensive commercial ties with Africa, that in the *Periplus of the Erythraean Sea* (ca. 75) the entire East African seaboard is known as the "Ausanitic Coast."

Following the rise of Axum, Africans assumed a highly aggressive role in Ethiopian-South Arabian relations. Around 195, for example, the Ethiopian king Gadara appears as the most dominant figure in South Arabia. A century later, the Ethiopian king Azbah dispatched military contingents to South Arabia, and afterwards sent Ethiopian soldiers as actual settlers.

Saba was again occupied by Ethiopia from 335 to 370. The effects of this occupation were perhaps more significant than those preceding it, in that this one firmly implanted Christianity on South Arabian soil, with the Sabean rulers themselves adopting the Christian faith. Christianity had already made considerable inroads in Arabia, as is evidenced by the attendance in 325 of six Arabian bishops at the historic Council of Nicea. Christianity was to play a critical role in the remaining years of pre-Islamic Arabia. Initially, for example, the Christian church suppressed the burning of incense during religious rituals by deeming it a pagan tradition, and consequently an impediment to Christianity itself.

After a brief resurgence of Sabean power under the leadership of Malikkariyb Yuhad'in, South Arabia, which in addition to its Christian population had attracted large numbers of Jews, witnessed an increasingly antagonistic relationship between the two religions and their adherents. The result was a violent period of Christian persecutions and church burnings. This especially virulent epoch of Christian martyrdom provoked a strong response in Ethiopia, then headed by Ella Asbeha—known as a formidable advocate of "Christian enlightenment." It is said, in fact, that a total of seven different Christian saints lived under Ella Asbeha's generous patronage.

In 524, a powerful coalition composed of the Eastern Roman Empire, Christian refugees from South Arabia, and the Kingdom of Axum, was organized for the specific purpose of invading South Arabia and unseating its ruling class. Byzantium supplied the ships, South Arabian refugees the advance guard, and the Axumites the bulk of the fighting forces. The coalition soon achieved its goals, and in the *Book of Himyarites* and the *Martyrdom of Arethius*, we read of a decisive battle along the southern Arabian coast where the South Arabian king literally lost his head.

After a period of seven months Ella Asbeha returned to Africa, leaving behind him a joint government of the South Arabian nobility and the Ethiopian military. This arrangement lasted until 532 when Abreha, a junior

Ethiopian military officer, seized the South Arabian throne. The 3,000 man Ethiopian army sent to suppress the revolt quickly defected to Abreha. A second expeditionary force was rapidly and soundly smashed. Abreha's stunning success was apparently facilitated by the deep class contradictions within Ethiopian society (including the military), creating a base from which a junior officer could rise to become one of the major personalities in early Arabian history.

Although officially acknowledging Ethiopia's overall supremacy, Abreha worked unceasingly to strengthen South Arabia's autonomy; helping extend its influence into the northern and central portions of the Arabian peninsula. After his death in 558, Abreha's exploits were recorded and embellished in Arabian, Byzantine and Ethiopian literature, and no history of pre-Islamic Arabia is complete without him.

One of the most illustrious single figures in pre-Islamic Arabia was Antar (ca. 525–615). Graham W. Irwin notes that:

There has always been a considerable population in Arabia of African origin. Perhaps the most famous of these people was Antara. He had an Arab father and an Ethiopian mother and became in time the national hero of the Arabs. That's not too strong a statement. There was nobody to equal the valor and strength of Antara. He's rather like King Arthur in the English tradition but, in fact, more important, because he was a more historical figure.⁵

Before the advent of Islam, southern Arabia already possessed, as we have emphasized, large and influential Christian and Jewish communities. She also possessed the sacred Kaaba sanctuary, with its black stone, at Makkah. Makkah was considered a holy place and the destination of pilgrims long before Muhammad. At the same time Allat, the Arabian goddess supreme, was worshipped at Ta'if, in Makkah's immediate proximity. Allat may have been regarded as the ultimate reality in female form. She was worshipped in the form of an immense uncut block of granite, as firm as the earth she represented. The most solemn oaths were sworn to Allat beginning with the words, "By the salt, by the fire, and by Allat who is the greatest of all." Another significant Arabian deity, Dhu-al-Shara, was represented by a quadrangular block of black stone.

It was in this rich religious tradition that the prophet Muhammad, who was to unite the whole of Arabia, was born. The seeds of Islam were already ripe and Africa was instrumental in its growth. According to tradition, the first Muslim killed in battle was Mihdja — a Black man. Another Black man, Bilal, was such a pivotal figure in the development of Islam that he has been referred to as "a third of the faith." Many of the earliest Muslim converts were Africans, and a number of the Muslim faithful sought refuge in Ethiopia because of Arabian hostility to Muhammad's teachings:

Five years after the proclamation of Islam (615), a number of Muslims sought refuge in neighboring Ethiopia in order to escape the persecutions of the Kurayshites in Mecca.... Their sojourn in Ethiopia greatly impressed these early Muslim migrants and influenced the future development of their new faith. Muslim biographical sources (*tabakat*) enumerate not a few Ethiopian converts to Islam who migrated to Medina and ranked amongst the Prophet's companions. They were referred to as the 'Ethiopian monks' (*ruhban al-habasha*).⁶

It was this relationship which caused Muhammad to declare that, "Who brings an Ethiopian man or an Ethiopian woman into his house, brings the blessing of God there."⁷

Another eminent Black man, Ata ibn Abi Rabah (ca. 700), became a mufti at Makkah. He was born in southern Arabia of Nubian parents. Eventually he moved to Makkah and became a famous teacher and jurisconsult there. In his later years his reputation spread far and wide. According to some accounts, including the brilliant black writer and historian Uthman Amr ibn-Bahr al-Jahiz, the prophet Muhammad himself was partly of African lineage. According to al-Jahiz, the guardian of the sacred Kaaba — *Abd al-Muttalib*, "fathered ten Lords, Black as the night and magnificent." One of these men was Abdallah, the father of Muhammad.⁸

Notes

1. Philip K. Hitti, *History of the Arabs* (New York: St. Martin's Press, 1970), 555. "Mauretania is the ancient name of the northwestern angle of the African continent, and under the Roman empire also of a large territory eastward of that angle. The word Mauretania or Maurusia as it was called by the Greek writers, signifies the land of the Mauri which is still retained in the modern Morocco. Since 1904 the French have used the term to apply to the territory north of the lower Senegal under French protection." Glora M. Wysner, *The Kabyle People* (n.p.: Wysner, 1945), 18.
2. Frank M. Snowden, *Before Color Prejudice* (Cambridge, MA: Harvard University Press, 1983), 9.
3. Procopius, *History of the Wars*, bk. 4, trans. and ed. H.B. Dawing (Cambridge, MA: Harvard University Press, 1954), x. 13.
4. J.B. Friedman, *The Monstrous Races in Medieval Art* (Cambridge, MA: Harvard University Press, 1981), 89.
5. *The Compact Edition of the Oxford English Dictionary*, vol. 2 (London: Oxford University Press, 1979), 3244.
6. Paul Edwards and James Walvin, "Africans in Britain, 1500–1800," in *The African Diaspora: Interpretive Essays*, eds. Martin L. Kilson and Robert I. Rotberg (Cambridge, MA: Harvard University Press, 1976), 172–73. "An Irish Gaelic saga of the 900s (copied in 1643) states that Danish-Irish raiders attacked Spain and Mauritania in the 800s. From the latter place they 'carried off a great host of them as captives to Erin, and these are the blue men [of Erin], for Mauri is the same as black man, and Mauritania is the same as blackness.... Long indeed were these blue men in Erin.'" Jack D. Forbes, *Black Africans and Native Americans* (New York: Basil Blackwell, 1988), 68.

7. "A rich source of information about medieval Spain is the illuminations which illustrate the *Cantigas*, a collection of narrative didactic-religious poems, which recount the miracles of the Virgin Mary. Written in Portuguese by Alfonso the Wise, king of Christian Spain, these poems and their miniatures are a veritable sociological study of thirteenth-century Spain. The illustrations portray individuals of all strata of Spanish society from Christian kings and Moorish knights to humble peasants and pregnant women. The artistic representation reflects the social reality, for Spain in the thirteenth century was an ethnic *potpourri*, blending the culture of the Jews and the Moors of Al-Andalus (southern Spain) with that of the Latinized and Christianized kingdoms of the north." Miriam DeCosta, "The Portrayal of Blacks in a Spanish Medieval Manuscript," *Negro History Bulletin* 37, No. 1 (1973), 194.

8. "Christian thought had come to equate sin and death with the color black, and concluded that evil and the devil's works were associated with blackness. To Christians, the Muslim invaders were infidels, and the black Moors in their ranks were fearsome symbols of living evil. Thus, in art of the period illustrating tales of Christ and the saints, the executioners and torturers are often depicted as Blacks." *The Image of the Black in Western Art: Smithsonian Institution Traveling Exhibition Service* (Washington, D.C.: Smithsonian Institution Press, 1980), 5.

9. Miriam DeCosta, "The Portrayal of Blacks in a Spanish Medieval Manuscript," *Negro History Bulletin* 37, No. 1 (1973), 194.

10. Colin Smith, *Christians and Moors in Spain, Volume 1: 711-1150* (Warminster: Aris & Phillips, 1988), 55.

11. Jean Devisse, "The Appeal to the Ethiopian," *Image of the Black in Western Art*, vol. 2, pt. 2, trans. W.G. Ryan. (New York: Morrow, 1979), 88.

12. Richard Hakluyt, *The Principal Voyages, Traffiques and Discoveries of the English Nation*, vol. 4 (Glasgow: James MacLehose & Sons, 1905), 143. "By the sixteenth century the English and Scots were referring to the people of Africa as Moors ..." Forbes, 83.

13. Elmer E. Stoll, *Othello, An Historical and Comparative Study* (Minneapolis: University of Minnesota, 1915), 46.

14. "The term *more* and its equivalents were widely used in late-medieval and early modern Europe. According to Simonet in his study of the language spoken by the Mozarabes (Christian Spaniards under Muslim rule before 1492) *mauro* meant *negro* and corresponded to Castillian usage in which *moro* was applied to horses whose color was *negro*. The corresponding *more* (French), *maurus* (Hispanic Latin), and *moro* (Valencian) were derived from Latin *morus* (*negro*) and ultimately from a Greek word meaning *oscuro*. Similarly, Mozarabic *mauro* (*negro*) was related to *moro* (Spanish and Italian), *mouro* (Portuguese and Gallego), *mor* (Provençal), *maure* and *more* (French), meaning 'Moro; negro; hombre de color'. These forms stemmed from Latin *maurus* (also from Greek), 'for the dark (*oscuro*) color of the *Mauritanos* o' *Moros* (peoples of northwest Africa)'.

The use of moor in the Dutch language will be discussed below, but here it is useful to note that the medieval Dutch understood by that term a very dark color, so that the color of coal was compared with that of a moor. Also it was said: 'scijnt swaert ghelike den more,' "he is as black as a moor." Forbes, 67-68.

15. Thomas Glick, *Islamic and Christian Spain in the Early Middle Ages* (Princeton: Princeton University Press, 1979), 14-15. "The Maghriban Arab historian and sociologist of the fourteenth century, Ibn Khaldun, distinguished three major groups amongst the Berbers: Zanata, Sanhaga, and Masmuda.... The Zanata Berbers, whose original home was in Tripolitania and southern Tunisia, were predominately nomadic during the first centuries after the Arab conquest of the Maghrib. They cooperated with the Arab invaders more than the other major Berber groups, and consequently

they have become more Arabized. Their close association with the Arabian tribes that invaded the Maghrib in the eleventh century, especially in the conflict for power at the end of the Almohad period, made some of the Zanata tribes claim Arabian descent. The dialect of the Zanata, Znatyya, is now spoken on the eastern fringes of the desert, in small islands in the central Maghrib, in the Rif, and in the northern parts of the Middle Atlas. The Sanhaga are as widely dispersed in the Maghrib as are the Zanata. They are split into two main branches: the Kabylia Berbers, who are sedentary, and the nomadic Zanaga (the name being a corruption of 'Sanhaja'), whose traditional home has been the western Sahara from Senegal to the southern parts of the Anti-Atlas. The Masmuda are the sedentary Berbers of Morocco, whose original home is in the western part of the High Atlas. They are now also spread over the area from the surroundings of Rabat to Azru (Azrew) and Khanifra." Jamil M. Abun-Nasr, *A History of the Maghrib* (London: Cambridge University Press, 1971), 8-9.

"Gsell points out that in Maghreb the term *Berber* is not racial dating from an earlier period, that it is simply the Latin word *barbarus*, or as was said in Roman Africa, *barbar*. Before the invasion of the Arabs it designated the indigenous population which remained resistant to the Latin civilization.

Ibn Khaldoun says that when Ifricas invaded Maghreb and saw the people and heard them speaking a language in which the varieties and the dialects struck his attention, he gave way to his astonishment by crying, 'What *berbera* is yours!' Thus they were called Berbers. The word *berbera* signifying in Arabic, 'a mixture of unintelligible cries.'

Ancient historians and geographers mention the Berbers under various names: the Nasamones and Psylli in Cyrenaica and Tripolitania; the Garamantes leading a nomadic life in the Sahara, the Makyles and Maxices in the Tunisian Sahel, the Musulani and the Numidians in the eastern Maghreb, the Gaetuli on the borders of the desert and the high tablelands, and lastly the Mauri occupying central and western Maghreb." Wysner, 19.

Cheikh Anta Diop offers another perspective on the Berbers. He notes that, "The confusion over the term *Berber* must be pointed out ... The root of this word, used during Antiquity, was probably of Negro rather than Indo-European origin. In reality, it is an onomatopoeic repetition of the root *Ber*. This kind of intensification of a root is general in African languages, especially in Egyptian." Cheikh Anta Diop, *African Origin of Civilization*, ed. and trans. Mercer Cook (Westport: Lawrence Hill, 1974), 55.

16. Lloyd Thompson, *Romans and Blacks* (Norman: University of Oklahoma Press, 1989), 63.

17. Harold A. MacMichael, *A History of the Arabs in the Sudan*, vol. 1 (New York: Barnes & Noble, 1967), 32.

18. F. DeMedeiros, "The Peoples of the Sudan: Population Movements," in *UNESCO General History of Africa. Vol. 3: Africa from the Seventh to the Eleventh Century*, ed. M. El Fasi (Berkeley: University of California Press, 1988), 125.

19. Quoted by E.W. Bovill, *The Golden Trade of the Moors*, 2d ed. (London: Oxford University Press, 1970), 48. Tenth century Arab geographer Ibn Hawkal was a native of Baghdad. He spent twenty-five years in travel, and claimed that his *Book of Ways and Provinces* contained all that had "ever made geography of interest to either princes or peoples." He visited Audoghast and Kumbi, the capital of Ghana, and saw the Niger flowing eastwards, which led him to believe it to be the Nile of Egypt. He may have been the first Arab writer to voice an unmistakable contempt for Black people, of whom he wrote: "I have not described the country of the African blacks and the other peoples of the torrid zone: because naturally loving wisdom, ingenuity, religion, justice and regular government, how could I notice such people as these, or magnify them by inserting an account of their countries." Bovill, 61-62.

The Tunisian born Ibn Khaldun (1332–1406), “considered the greatest of Arab historians” expressed a similar disdain for Black people. In his *Muqaddimah* (An Introduction to History), in which he treated history as a science and outlined a philosophy of history, Ibn Khaldun wrote that, “We have seen that Negroes are in general characterized by levity, excitability, and great emotionalism. They are found eager to dance whenever they hear a melody. They are everywhere described as stupid.” Ibn Khaldun, *The Muqaddimah*, trans. Franz Rosenthal (Princeton: Princeton University Press, 1967), 63.

20. Bernard Lewis, *Race and Slavery in the Middle Ages* (London: Oxford University Press, 1990), 124. “Ham was the middle child of Noah’s three sons, Shem, Ham, and Japheth. The name ‘Ham’ means ‘hot,’ ‘heat,’ and by application, ‘black ...’ The name ‘Ham’ is patronymic of his descendants.” Walter Arthur McCray, *The Black Presence in the Bible*, vol. 1 (Chicago: Black Light Fellowship, 1990), 54. The four sons of Ham were: Cush (Ethiopia), Mizraim (Egypt), Phut (Libya), and Canaan (Phoenicia). Genesis 10:6.

21. ‘Uthman ‘Amr ibn-Bahr al-Jahiz, *The Book of the Glory of the Black Race* (Los Angeles: Preston, 1981), 55–56. Al-Jahiz was born in Basra, Iraq in 778. A brilliant scholar and a prolific writer, he lived during an era marked by a visible increase in racial hostility directed by Arabs against Blacks in the Islamic world. One of the most extreme reactions to this policy was the massive slave insurrection launched in 868 (the year of al-Jahiz’s death), known in Arab histories as the Revolt of the Blacks. For a concise overview, see *The Life and Works of Jahiz*, trans. and ed. Charles Pellat (Berkeley: University of California Press, 1969). For a more African-centric perspective on al-Jahiz, see J.A. Rogers’ *World’s Great Men of Color*, vol. 1 (New York: Collier-Macmillan, 1972).

22. Lewis, 248.

23. H.T. Norris, *The Berbers in Arabic Literature* (London: Longman, 1982), 20.

24. Quoted by Norris, 20.

25. *Oxford English Dictionary*, 2639.

26. Smith, viii.

27. D.M. Dunlop, *Arab Civilization to 1500 A.D.* (New York: Praeger, 1971), 271.

28. *Oxford English Dictionary*, 2639.

29. “The *Kaaba* was reputed to have been constructed by Ishmael, son of Abraham and Hagar the Egyptian (a Negro woman), historical ancestor of Mohammed, according to all Arab historians.” Diop, 127. “In Egypt he [Abraham] had married a Negro woman, Hagar, mother of Ishmael, the Biblical ancestor of the second Semitic branch, the Arabs. Ishmael was said to be the historical ancestor of Mohammed.” Diop, 136.

The name Semite comes from Shem, the eldest of the three sons of Noah. The Bible identifies Shem as the father of Ashur, Aram and Heber, and alleged ancestor of the Arabs, Assyrians, Aramaeans and Hebrews. In Greek and Latin versions of the Bible, Shem becomes Sem, since neither Greek nor Latin has any way of representing the initial sound of the Hebrew name. The Bible tells us that everyone on earth was drowned except for Noah and his family and that all mankind are descended from his three sons, Shem, Ham, and Japheth. The lines of descent from the three of them, described in the tenth chapter of Genesis, represent a kind of mythologized ethnology, enumerating the peoples of antiquity whose names were known when this chapter was written, and setting forth the relationships between them.

The adjective Semitic is thought to have been introduced in 1780 by a German scholar, August Ludwig Schlozer, to qualify a series of closely related languages. According to Schlozer, “The Syrians, Babylonians, Hebrews and Arabs ... spoke this language, which I might call the Semitic.” Eventually the people who spoke these languages were called Semites. As the word race is used at the present time, the

Semites were never a race. The earliest accounts and pictures show them to have been of diverse racial origins and types. Bernard Lewis, *Semites and Anti-Semites* (New York: W.W. Norton, 1986), 43–45.

30. Jean-Paul Clebert, *The Gypsies* (New York: Penguin, 1970), 69–70.

31. Clebert.

32. J. Devisse, “From the Demonic Threat to the Incarnation of Sainthood,” *The Image of the Black in Western Art. Vol. 2, From the Early Christian Era to ‘The Age of Discovery.’ Pt. I*, trans. W.G. Ryan (New York: Morrow, 1979), 88.

33. Dorothee Mitlitzki, *The Matter of Araby in Medieval England* (New Haven: Yale University Press, 1977), 193.

34. Mitlitzki.

35. H.T. Norris, *The Berbers in Arabic Literature* (London: Longman, 1982), 14.

36. *The Song of Roland*, trans. F. Goldin (New York: W.W. Norton, 1978), 99.

37. *The Song of Roland* (New York: Heritage Press, 1938), 58.

38. *The Song of Roland*, trans. F. Goldin (New York: W.W. Norton, 1978), 107.

39. Devisse, 88.

40. 116.

41. Mitlitzki, 194.

42. It is interesting to note that while perhaps not Saracens, “The legends and the history of the Scottish Highlands are both witnesses to the existence of purely black people. The Welsh traditions bear a similar testimony. The hero Peredur, Son of Evrawc, discovers a company of ‘bald, swarthy youths,’ sitting at the hall-door of a black giant, playing at chess. This giant is styled the Black Oppressor, and seems to have been of the same genial nature as the ‘black knight’ of Ashton-under-Lyne. He very frankly informs Peredur that ‘for this reason I am called the Black Oppressor, that there is not a single man around me whom I have not oppressed; and justice have I done unto none.’

Kynon, the son of Clydno, encountered another of those black people, a black giant with an iron club, — and such giants swarm throughout the Welsh tales. ‘The *Mabinogion* (says Mr. Wirt Sikes) ... are full of black men, usually giants, always terrible to encounter.’ David MacRitchie, *Ancient and Modern Britons*, vol. 1 (London: Kegan Paul, Trench, Trubner, 1884), 153–54.

43. *Orkneyinga Saga*, trans. H. Palsson (London: Hogarth Press, 1978), 157.

44. 157.

45. Paul Edwards and James Walvin, *Black Personalities in the Era of the Slave Trade* (Baton Rouge: Louisiana State University Press, 1983), 4.

46. B.H. Warmington, “The Carthaginian Period,” in *UNESCO General History of Africa. Vol. 2: Ancient Civilizations of Africa*, ed. G. Mokhtar (Berkeley: University of California Press, 1981), 462.

47. Livy, *The War with Hannibal*, trans. Aubrey De Selincourt (Harmondsworth: Penguin, 1965), 45; see also Wayne B. Chandler, “Hannibal: Nemesis of Rome,” in *Great Black Leaders*, ed. Ivan Van Sertima (New Brunswick: Journal of African Civilizations, 1987), 282–321.

48. B.H. Warmington, *Carthage* (New York: Praeger, 1969), 46.

49. Graham Webster, *The Roman Imperial Army of the First and Second Centuries* (London: Adams & Charles Black, 1969), 46; see also Sallust, *Jugurthine War*, trans. S.A. Handford (Harmondsworth: Penguin, 1965).

Dacia was a Roman province north of the Danube, roughly present-day Romania. It was chiefly valuable for its gold and silver mines, which had probably been used since prehistoric times. The main cities of the province were Sarmizegethusa and Apulum.

50. F.H. Eterovich and C. Spalatin, eds, “The Roman Colonization of Moors in

the Balkans and in Other Regions of Europe," in *Croatia: Land, People, Culture*, vol. 2. (Toronto: University of Toronto Press, 1970): 384.

51. M. Rostovtzeff, *The Social and Economic History of the Roman Empire* (Oxford: Clarendon Press, 1926), 390.

52. A.H.M. Jones, *The Later Roman Empire 284-602*, vol. 1 (Norman: University of Oklahoma Press, 1963), 643. "Numidia was the name given in ancient times to a tract of country in the north of Africa extending along the Mediterranean from the confines of Mauretania to those of the Roman province of Africa. Numidia comes from the word *nomad* and was given by the Greeks. The limits of Numidia varied at different epochs of North African history. Finally under the new organization of the empire by Diocletian, Numidia became one of the seven provinces of Africa, being known as Numidia Cirtensis, closely corresponding in extent to the modern French province of Constantine." Wysner, 18.

53. Will Durant, *Caesar and Christ: A History of Roman Civilization and of Christianity from their Beginnings to A.D. 325* (New York: Simon & Schuster, 1944), 431.

54. Abdallah Laroui, *The History of the Maghrib*, trans. Ralph Manheim (Princeton: Princeton University Press, 1977), 17.

55. W.T. Arnold, *Studies of Roman Imperialism* (Manchester: Manchester University Press, 1906), 80.

56. Procopius, 321.

57. Snowden, 8.

58. Quoted by Edward Gibbon, *The Decline and Fall of the Roman Empire, Vol. 3: 1185 A.D.-1453 A.D.* (New York: Modern Library, n.d.), 195. The Visigoths were a major division of the Goths — one of the chief groups of ancient Germans. Separated from the Ostrogoths (East Goths) around 376 C.E., the Visigoths moved into Roman territory under pressure from the Huns. Eventually the Visigoths expanded north to the Loire, made Toulouse their capital, and seized the lands of the Vandals (another Germanic group) in Spain. They became Christians and gradually merged with the Spanish population.

59. Abdulwahid Dhanun Taha, *The Muslim Conquest and Settlement of North Africa and Spain* (London: Routledge, 1989), 86.

60. Norris, 63.

61. Taha, 103.

62. Bernard Lewis, *Islam, Vol. 1: Politics and War* (New York: Walker, 1974), 110-12.

63. Smith, 19.

64. A.R. Nykl, *Hispano-Arabic Poetry* (Baltimore: J.R. First, 1946), 318.

65. Lewis, 91.

66. Ferdinand Gregorovius, *History of Rome, Vol. 3: 800-1002 A.D.* (London: George Bell, 1903), 66.

67. Norman Daniel, *The Arabs and Medieval Europe* (London: Longman, 1979), 58.

68. Paul Kaplan, *The Rise of the Black Magus in Western Art* (Ann Arbor: University of Michigan Press, 1985), 10.

69. Bernard Lewis, *Islam, Vol. 2: Religion and Society* (New York: Walker, 1974), 217.

70. Norris, 106.

71. H.T. Norris, *Saharan Myth and Saga* (London: Clarendon Press, 1972), 65.

72. DeCosta, 194.

73. Norris, 135.

74. Gude Suckale-Redlefsen, *The Black Saint Maurice* (Houston: Menil Foundation, 1987), 19.

75. *Morien*, trans. Jessie L. Weston (London: Nutt, 1901), 29.

76. "How warmly Sir Gawain thanked Morien, that he had saved his life that day on the field, where he had of a surety been slain had not God and that good knight come to his aid." *Morien*, 109.

77. 35.

78. 38-39.

79. 41.

80. 98.

81. 31.

82. Gerald Massey, *A Book of the Beginnings*, vol. 1 (1881; rpt. Secaucus: University Books, 1974), 218.

83. Forbes, 79.

84. Allison Blakely, "Santa's Black Aide: A Glimpse at Race Relations in Holland," *New Directions* (Jan 1980), 26.

85. Paul Edwards and James Walvin, "Africans in Britain, 1500-1800," in *The African Diaspora*, eds. Martin L. Kilson and Robert I. Rotberg (Cambridge, MA: Harvard University Press, 1976), 173. "The spread of *maurus* to the north can also be seen in Scotland where, in 1504-5, several references to 'More lasses' (Moor lassies) are found. At that time a child was born, referred to as 'Moris barne' (*a maurus born*). Late in 1512-13, one finds 'Elen More' and 'Blak Elene' used (one assumes) interchangeably. By 1527 'Helenor, the black moir' is referred to, while in 1567-9 there are references to 'Nageir the More.' " Forbes, 67-68.

86. "It is possible to go further back than the middle of the sixteenth century and find historical documents to prove that even as early as 1501 there were blacks at court in Scotland. That year one of the King's minstrels was "Peter the Moryen or Moor," and three years later two blackamoor girls arrived and were educated at court where they waited on the queen. They were baptized Elen and Margaret, and in June, 1507, a tournament was held in honor of the Queen's black lady, Elen Moore "which was conducted with great splendour." Edward Scobie, *Black Britannia* (Chicago: Johnson, 1972), 8.

87. 8.

88. Even Britain's "Morris" dances are thought to have derived from Moorish models. "The so-called Morris Dance which sometimes accompanies the play has a much deeper meaning still to be elucidated.... Such a dance is not the exclusive property of any one nation, and therefore when Crusading armies met it among their allies, and their enemies, they might attach the name of 'Morris' and 'Morisco' to it. Probably, too, when attempting to dramatize current events, they would black their faces and pretend to be Moors. This may explain the curious Morris Dances of Bacus in Lancashire and Provence, where the dancers wear half coconuts on their knees, waists, and hands, and clap out intricate rhythms as they dance energetically, in much the same way that young men in certain Turki tribal rituals slap themselves with their bare hands. The use of the coconut reinforces the suggestion that this dance was a copy of Moorish antics, for the coconut is of African origin, just as the floating ostrich plumes of the Basque Morris dancers also originated in Africa." J. Lawson, *European Folk Dance*, rev. ed. (London: Pitman, 1955), 14-15.

David MacRitchie, author of *Ancient and Modern Britons*, was convinced that the Moors were Black people who played an important role in the early settlement of Britain: "For although it may not be easy to trace their route hither, and the date of their arrival, a branch of this family did inhabit Britain, and are not only known as

Mauri and Moors, but also as *Moravienses*, *Morienses*, *Murray-men*, and people of *Moray* or *Moravia*." MacRitchie, 50.

"The 'Moors' are still largely represented throughout the British Islands; although of course the crossing and re-crossing of thirty generations, while increasing the number of descendants, has lessened the intensity of the resemblance to the ancestral stock. But the swarthy hue asserts itself still, though in a modified degree. Last century, when Martin described the *Western Islands of Scotland*, he remarked that the complexion of the natives of Skye was 'for the most part black,' of the natives of Jura he said that they were 'generally black of complexion,' and of Arran that they were 'generally brown, and some of black complexion.'" MacRitchie, 122.

Notes to Appendix: The African Presence in Early Arabia

1. As long ago as 1871 Francois Lenormant (1837–1883), a prominent French archaeologist and member of the Academy of Inscriptions and Belles-Lettres, stressed that, "We may perceive the remembrance of a powerful empire founded by the Cushites in very earlier ages, apparently including the whole of Arabia Felix, and not only Yemen proper.

Circumcision established in Yemen from remotest antiquity, and several other pagan usages, still practiced in our days, appear to be of Cushite origin. Lokman, the mythical representative of Adite wisdom, resembles Aesop, whose name ... seems to indicate an Ethiopian origin." Francois Lenormant, *A Manual of the Ancient History of the East to the Commencement of the Median Wars*, vol. 2 (Philadelphia: J.B. Lippincott, 1871), 296.

2. Both frankincense and myrrh occupied tremendously vital places in the pharaonic civilization of Africa's Nile Valley. Frankincense, for example, while extensively utilized for its perfume-like fragrance, was equally valued for its medicinal properties. It was used both in the stoppage of bleeding and as an antidote for poisons. Myrrh was employed for cosmetics and ointments, and formed an essential element in the mummification process.

3. James B. Pritchard, *Ancient Near East* (London: Oxford University Press, 1958), 196–97.

4. "Lokman is the most celebrated sage of the East. So great is his fame there that there is still a saying, 'To teach wisdom to Lokman,' which is the equivalent of 'Carrying coals to Newcastle.' In Islam his fame equals that of Solomon in the Christian-Jewish world. Mohammed quoted him as an authority and named the thirty-first chapter of the Koran after him.

Much that is said about him is legendary. The Arabs say that he lived about 1100 B.C., was a coal-black Ethiopian with woolly hair, and was the son of Baura, who was a son or a grandson of a sister of Job. Lokman is often confused with Aesop, who was also a Negro, and who, it appears, adapted some of Lokman's fables to his own use." J.A. Rogers, *World's Great Men of Color*, vol. 1 (New York: Collier, 1972), 67.

5. Graham W. Irwin, "African Bondage in Asian Lands," *African Presence in Early Asia*, eds. Runoko Rashidi and Ivan Van Sertima (New Brunswick: Journal of African Civilizations, 1988), 146. "The name of 'Antarah ibn-Shaddad al'Absi (ca. 525–615), evidently a Christian, has lived through the ages as the paragon of Bedouin heroism and chivalry. Knight, poet, warrior and lover, Antarah exemplified in his life those traits greatly esteemed by the sons of the desert. His deeds of valor as well as his love episodes with his lady, 'Ablah, whose name he immortalized in his famous Mu'allaqah, have become a part of the literary heritage of the Arabic-speaking world." Philip K. Hitti, *History of the Arabs*, 6th ed. (London: Macmillan, 1956), 96.

"His fame as a literary character transcends that of the modern authors of black

blood, such as Pushkin in Russia, and the elder Dumas in France. After his death the fame of Antarah's deeds spread across the Arabian Peninsula and throughout the Mohammedan world. In time these deeds, like Homeric legends, were recorded in a literary form and therein is found that Antarah, ... has become the Achilles of the Arabian Iliad, a work known to this day after being a source of wonder and admiration for hundreds of years to millions of Mohammedans as the 'Romance of Antarah.' The book, therefore, ranks among the great national classics like the 'Shah-nameh' of Persia, and the 'Nibelungen-Lied' of Germany. Antarah was the father of knighthood. He was the champion of the weak and oppressed, the protector of women, the impassioned lover-poet, the irresistible and magnanimous knight. 'Antarah' in its present form probably preceded the romances of chivalry so common in the twelfth century in Italy and France." A.O. Stafford, "Antarah, The Arabian Negro Warrior, Poet and Hero," *Journal of Negro History* 1, No. 2 (1916), 155.

6. Y. Talib, "The African Diapora in Asia," in *UNESCO General History of Africa. Vol. 3, Africa from the Seventh to the Eleventh Century*, ed. M. El Fasi (Berkeley: University of California Press, 1988), 710–11.

7. E. Cerulli "Ethiopia's Relations with the Muslim World," in *UNESCO General History of Africa. Vol. 3, Africa from the Seventh to the Eleventh Century*, ed. M. El Fasi (Berkeley: University of California Press, 1988), 576

8. 'Uthman 'Amr ibn-Bahr al-Jahiz, *The Book of the Glory of the Black Race*, trans. Vincent J. Cornell (Los Angeles: Preston, 1981), 50.

THE MOORS IN ANTIQUITY: A SELECTED BIBLIOGRAPHY

- Abercrombie, Thomas J. "When the Moors Ruled Spain." *National Geographic* 174, No. 1 (1988): 86–119.
- Abun-Nasr, Jamil M. *A History of the Maghrib*. London: Cambridge University Press, 1971.
- Allen, Alma C. "Literary Relations Between Spain and Africa." *Journal of Negro History* (Apr 1965): 97–105.
- Altamira, Rafael. *A History of Spain from the Beginnings to the Present Day*. Translated by Muna Lee. Princeton: D. Van Nostrand, 1949.
- Bendiner, E. *The Rise and Fall of Paradise: When Arabs and Jews Built a Kingdom in Spain*. New York: Dorset, 1983.
- Blakely, Allison. "Santa's Black Aide: A Glimpse at Race Relations in Holland." *New Directions: The Howard University Magazine* (Jan 1980): 26–29.
- Bovill, E.W. *The Golden Trade of the Moors*. 2d ed. Revised and with additional material by R. Hallet. London: Oxford University Press, 1970.
- Chandler, Wayne B. "The Moor: Light of Europe's Dark Age." *African Presence in Early Europe*. Edited by Ivan Van Sertima. New Brunswick: Journal of African Civilizations, 1985: 144–75.
- Chandler, Wayne B. "Hannibal: Nemesis of Rome." *Great Black Leaders: Ancient and Modern*. Edited by Ivan Van Sertima. New Brunswick: Journal of African Civilizations, 1987: 282–321.
- Cobb, Martha. "Afro-Arabs, Blackamoors and Blacks: An Inquiry into Race Concepts Through Spanish Literature." *Black World* 21 (Feb 1972): 32–40.
- Cox, George O. "The Umayyad Empire and Caliphate of Cordoba." Chap. in *African Empires and Civilizations: Ancient and Medieval*. Washington, D.C.: African Heritage Studies, 1974: 133–58.
- Cutler, A.H., and H.E. Cutler. *The Jew as Ally of the Muslim: Medieval Roots of Anti-Semitism*. Notre Dame: University of Notre Dame Press, 1986.
- Davidson, Basil. "The Ancient World and Africa: Whose Roots?" *Race and Class* 29, No. 2 (1987): 1–15.
- DeCosta, Miriam. "The Portrayal of Blacks in a Spanish Medieval Manuscript." *Negro History Bulletin* 37, No. 1 (1974): 193–96.
- DeCosta, Miriam, ed. *Blacks in Hispanic Literature: Critical Essays*. Port Washington: Kennikat Press, 1977.
- DeGraft-Johnson, J.C. *African Glory: The Story of Vanished Negro Civilizations*. Afterword by John Henrik Clarke. Baltimore: Black Classic Press, 1986.
- DeMedeiros, F. "The Peoples of the Sudan: Population Movements." *UNESCO General History of Africa. Vol. 3: Africa from the Seventh to the Eleventh Century*. Edited by M. El Fasi. Berkeley: University of California Press, 1988: 119–39.
- Devisse, J. *The Image of the Black in Western Art. Vol. 2, From the Early Christian Era to 'The Age of Discovery.'* Pt. 1: *From the Demonic Threat to the Incarnation of Sainthood*. Translated by W.G. Ryan. New York: Morrow, 1979.
- Edwards, Paul, and James Walvin. "Africans in Britain, 1500–1800." *The African Diaspora: Interpretive Essays*. Edited by Martin L. Kilson and Robert I. Rotberg. Cambridge, MA: Harvard University Press, 1976: 173–204.
- Eterovich, F.H., and C. Spalatin, eds. "The Roman Colonization of Moors in the Balkans and in Other Regions of Europe." Chap. in *Croatia: Land, People, Culture*, Vol. 2. Toronto: University of Toronto Press, 1970: 383–86.

- Hitti, Philip K. *History of the Arabs from the Earliest Times to the Present*. New York: St. Martin's Press, 1970.
- Hrbek, I., and J. Devisse. "The Almoravids." *UNESCO General History of Africa. Vol. 3: Africa from the Seventh to the Eleventh Century*. Edited by M. El Fasi. Berkeley: University of California Press, 1988: 336–66.
- Jackson, John G. "Africa and the Civilizing of Europe: The Empire of the Moors." Chap. in *Introduction to African Civilizations*. Secaucus: Citadel, 1974: 157–95.
- Jackson, John G. Introduction to *The Story of the Moors in Spain*, by Stanley Lane-Poole. Baltimore: Black Classic Press, 1990.
- Jackson, John G. *Ages of Gold and Silver*. Austin: American Atheist Press, 1990.
- Johnson, Rosalind. "African Presence in Shakespearean Drama: Parallels Between Othello and the Historical Leo Africanus." *African Presence in Early Europe*. Edited by Ivan Van Sertima. New Brunswick: Journal of African Civilizations, 1985: 276–87.
- Kaplan, Paul. *The Rise of the Black Magus in Western Art*. Ann Arbor: University of Michigan Press, 1985.
- Lane-Poole, Stanley. *The Moors in Spain*. With the collaboration of A. Gilman. London: T. Fisher Unwin, 1887.
- Lawson, J. *European Folk Dance*. Rev. ed. London: Pitman, 1955.
- Livy. *The War with Hannibal*. Translated by Aubrey De Selincourt, Harmondsworth: Penguin, 1965.
- The Mabinogion*. Translated with an Introduction by Gwyn Jones and Thomas Jones. London: Dent, 1957.
- MacRitchie, David. *Ancient and Modern Britons: A Retrospect*, 2 Vols. London: Kegan Paul, Trench, Trubner, 1884.
- Massey, Gerald. *A Book of the Beginnings: Containing an Attempt to Recover and Reconstitute the Lost Origines of the Myths and Mysteries, Types and Symbols, Religion and Language, with Egypt for the Mouthpiece and Africa as the Birthplace. Vol. 1, Egyptian Origines in the British Isles*. 1881; rpt. Secaucus: University Books, 1974.
- Mones, H. "The Conquest of North Africa and Berber Resistance." *UNESCO General History of Africa. Vol. 3: Africa from the Seventh to the Eleventh Century*. Edited by M. El Fasi. Berkeley: University of California Press, 1988: 224–45.
- Morien*. Translated from the Medieval Dutch by Jessie L. Weston. London: Nutt, 1901.
- Norris, H.T. *The Berbers in Arabic Literature*. London: Longman, 1982.
- Rashidi, Runoko. "Ancient and Modern Britons." *African Presence in Early Europe*. Edited by Ivan Van Sertima. New Brunswick: Journal of African Civilizations, 1985: 251–60.
- Ricard, Tarik, and Nijel Binns. Review of *The Story of the Moors in Spain*, by Stanley Lane-Poole. In *Community* 2, No. 8 (1990): 7–8.
- Rogers, Joel A. *Nature Knows No Color-Line: Research Into the Negro Ancestry in the White Race*. 3rd ed. New York: Rogers, 1952.
- Rogers, Joel A. "St. Maurice of Aganaum, Roman General and Saint of the Catholic Church." In *World's Great Men of Color*, Vol. 2. New York: Collier, 1972: 10–15.
- Sallust. *Jugurthine War*. Translated by S.A. Handford. Harmondsworth: Penguin, 1965.
- Sampson, Margaret. "Africa in Medieval Spanish Literature. Its Appearance in El Caballero Cifar." *Negro History Bulletin* (Dec 1969): 14–18.
- Scobie, Edward. *Black Britannia: A History of Blacks in Britain*. Chicago: Johnson, 1972.
- Scobie, Edward. "The Black in Western Europe." *African Presence in Early Europe*.

- Edited by Ivan Van Sertima. New Brunswick: Journal of African Civilizations, 1985: 190-202.
- Seiferth, Wolfgang S. "Saint Mauritius, African." *Phylon* 4th qtr. (1941): 370-76.
- Shakespeare, William. *Othello: The Moor of Venice*. Edited by G.E. Bentley. Baltimore: Penguin, 1970.
- Smith, Colin. *Christians and Moors in Spain, Vol. 1: AD 711-1150*. Warminster: Aris & Philips, 1988.
- Suckale-Redlefsen, Gude. *The Black Saint Maurice*. Foreword by Ladislav Bugner. Houston: Menil Foundation, 1987.
- The Song of Roland*. Introduction by Hamish Miles. New York: Heritage Press, 1938.
- The Song of Roland*. Translated with an Introduction by Frederick Goldin. New York: W.W. Norton, 1978.
- Valdes, Mario. "The Black Wiseman in European Symbolism." *Journal of African Civilizations* 3, No. 1 (1981): 67-85.
- Van Sertima, Ivan. "The African Presence in Early Europe: The Definitional Problem." *African Presence in Early Europe*. Edited by Ivan Van Sertima. New Brunswick: Journal of African Civilizations, 1985: 134-43.
- Warmington, B.H. "The Carthaginian Period." *UNESCO General History of Africa, Vol. 2: Ancient Civilizations of Africa*. Edited by G. Mokhtar. Berkeley: University of California Press, 1981: 441-64.

THE AFRICAN PRESENCE IN EARLY ARABIA: A SELECTED BIBLIOGRAPHY

- Brunson, James E. *The Black Canaanites from the Earliest Times*. DeKalb: Kara, 1990.
- Brunson, James E. *Image of the Black in West Asian Art*. DeKalb: Kara, 1990.
- Doresse, J. "Ethiopia and Southern Arabia During the III and IV Centuries According to Recent Discoveries." *Kush* 5 (1957): 59-60.
- Fleming, Beatrice J., and Marion J. Pryde. "Antar of Arabia." Chap. in *Distinguished Negroes Abroad*. Washington, D.C.: Associated Publishers, 1946: 10-20.
- Fleming, Beatrice J., and Marion J. Pryde. "Bilal, Black Muezzin." Chap. in *Distinguished Negroes Abroad*. Washington, D.C.: Associated Publishers, 1946: 21-30.
- Houston, Drusilla Dunjee. *Wonderful Ethiopians of the Ancient Cushite Empire*. 1926; rpt. Baltimore: Black Classic Press, 1985.
- Houston, Drusilla Dunjee. "Ethiopians in Old Arabia." *African Presence in Early Asia*. Edited by Runoko Rashidi and Ivan Van Sertima. New Brunswick: Journal of African Civilizations, 1988: 54-57.
- Irwin, Graham W., ed. *Africans Abroad: A Documentary History of the Black Diaspora in Asia, Latin America, and the Caribbean During the Age of Slavery*. New York: Columbia University Press, 1977.
- Irwin, Graham W. "African Bondage in Asian Lands." *African Presence in Early Asia*. Edited by Runoko Rashidi and Ivan Van Sertima. New Brunswick: Journal of African Civilizations, 1988: 146-51.
- al-Jahiz, Uthman Amr ibn Bahr. *The Book of the Glory of the Black Race*. Translated by Vincent J. Cornell. Los Angeles: Preston, 1981.
- Keith, Arthur, and M. Krogman. "The Racial Character of the Southern Arabs." Chap. in *Arabia Felix*, by Bertram Thomas. London: Jonathan Cape, 1932: 301-33.
- Kobishchanov, Yuri M. *Axum*. Edited by J.W. Michels. Translated by L.T. Kapitanoff. University Park: Pennsylvania State University, 1979.
- Kobishchanov, Yuri M. "Aksum: Political System, Economics and Culture, First to Fourth Century." *UNESCO General History of Africa, Vol. 2, Ancient Civilizations of Africa*. Edited by G. Mokhtar. Berkeley: University of California Press, 1981: 381-400.
- Lenormant, Francois, and E. Chevallier. *A Manual of the Ancient History of the East to the Commencement of the Median Wars, Vol. 2, Medes and Persians, Phoenicians, and Arabians*. Philadelphia: J.B. Lippincott, 1871.
- al-Mansour, Khalid Abdullah Tariq. *The Destruction of Western Civilization as Seen Through Islam, Christianity and Judaism*. San Francisco: First African Arabian Press, 1982.
- The Periplus of the Erythraean Sea: Travel and Trade in the Indian Ocean by a Merchant of the First Century*. Translated from the Greek and annotated by Wilfred H. Schoff. New York: Longmans, Green, 1912.
- Potts, D. "The Road to Meluhha." *Journal of Near Eastern Studies* (Oct 1982): 279-88.
- Rashidi, Runoko. "Ancient Blacks in Southern Arabia." Chap. in *Kushite Case-Studies*. Los Angeles: Know Thyself, 1983: 44-51.
- Rashidi, Runoko. "Dr. Diop on Asia: Highlights and Insights." *Great African Thinkers, Vol. 1: Cheikh Anta Diop*. Edited by Ivan Van Sertima and Larry Williams. New Brunswick: Journal of African Civilizations, 1986: 127-45.
- Rashidi, Runoko. "Africans in Early Asian Civilizations: A Historical Overview."

- African Presence in Early Asia*. Edited by Runoko Rashidi and Ivan Van Sertima. New Brunswick: Journal of African Civilizations, 1988: 15–52.
- Rashidi, Runoko. "Black Bondage in Asia." *African Presence in Early Asia*. Edited by Runoko Rashidi and Ivan Van Sertima. New Brunswick: Journal of African Civilizations, 1988: 144–45.
- Rogers, Joel A. *Sex and Race, Vol. 1: The Old World*. New York: Rogers, 1967.
- Rogers, Joel A. *World's Great Men of Color*, 2 Vols. Edited with an Introduction, Commentary, and New Bibliographical Notes by John Henrik Clarke. New York: Collier, 1972.
- Stafford, A.O. "Antar, The Arabian Negro Warrior, Poet and Hero." *Journal of Negro History* 1, No. 2 (1916): 151–62.
- Talib, Y. "The African Diaspora in Asia." *UNESCO General History of Africa. Vol. 3, Africa from the Seventh to the Eleventh Century*. Edited by M. El Fasi. Berkeley: University of California Press, 1988: 704–33.

THE EMPIRE OF THE MOORS

John G. Jackson

Compiled, with an Appendix, by Runoko Rashidi

The Moors were people who lived in Morocco. That's the reason they called it that. The word *Moor* meant *Black*. It meant Black people. In ancient times all Africans were called *Ethiopians* or *Kushites*. And in the Middle Ages the Africans were called *Moors*.¹ The word *Moor* literally means *Black*, so the Moorish people were the Black people. In medieval times the name *Moor* was not restricted to the inhabitants of Morocco, but it was customary to refer to all Africans as *Moors*. The highly ambiguous word *Negro* had not yet been invented. This word *Negro* came up when the slave-trade came in. In other words, you have a lot of little fish floating around in the ocean. They're little fish and they have various names. But if you put them in cans they all become sardines. So when they put the Black man in slavery he became a *Negro*. We know from the contemporary records which have come down to us from the era of medieval Moorish supremacy that the Moors did not consider themselves as white men.¹

The Moors in North Africa were converted to Islam during the seventh century. An army of twelve thousand Africans was recruited and placed under the leadership of the Moorish general, Tarik. Tarif was an officer in Tarik's army. He led the first expedition to Spain to find out what the Moors had to face. The army landed at a place later named Tarifa in honor of Tarif. He set up a custom house there. He found out that they had no serious opposition to face in Spain. Tarif and his small detachment plundered Algericas and other towns and returned to Africa with their boats loaded with spoils.

There was a kingdom of the Visigoths — the western Goths. There was a Greek governor in a place called Ceuta on the African coast. The story is that Count Julian (the Greek governor) sent his daughter on a vacation to visit King Roderick and he raped his daughter. Julian persuaded the Moors to invade Spain because he said it was unprotected. All they had to do was walk in and take it.

General Tarik and his army landed on an isthmus between an encarpment, then called Mons Calpe, and the continent of Europe. After that, Mons Calpe

¹This essay was compiled from an interview with John G. Jackson in September 1990. Quotes from the interview are combined with excerpts from John G. Jackson's, *Introduction to African Civilizations*. It is dedicated to Willis N. Huggins, J.C. deGraft-Johnson and J.A. Rogers, on whom notes are given at the end of the piece.

was renamed Gebel Tarik — The Hill of Tarik — or, as we now call it, Gibraltar. Tarik's African army captured a number of Spanish towns near Gibraltar, among them, Heraclea. Then he advanced northward into Andalusia. The Visigothic King Roderick learned of the invasion and raised an immense army for the defense of Spain. The two opposing armies met in battle near Xeres not far from the Gaudalete River.

After overrunning most of the Iberian Peninsula, the Moors pushed on through to France, where they were repulsed with heavy losses at Poitiers by the Franks under Charles Martel — the grandfather of Charlemagne. After this significant setback, they retired into Spain and there laid the foundations of a new civilization. The country was immeasurably enriched by their labors. They, for instance, introduced the silk industry into Spain. In the field of agriculture they were highly skilled, and introduced rice, sugar cane, dates, ginger, cotton, lemons, and strawberries into the country.

The Spanish city of Cordova, in the tenth century, was very much like a modern city. Its streets were well paved and there were raised sidewalks for pedestrians. At night, one could walk for ten miles by the light of lamps, flanked by an uninterrupted extent of buildings. This was hundreds of years before there was a paved street in Paris, France, or a street lamp in London, England. The population of Cordova was over a million. There were 200,000 homes, 800 public schools, and many colleges and universities. Cordova possessed 10,000 palaces of the wealthy, besides many royal palaces, surrounded by beautiful gardens. There were even 5,000 mills in Cordova at a time when there was not even one in the rest of Europe. There were also 900 public baths, besides a large number of private ones, at a time when the rest of Europe considered bathing as extremely sinful, and to be avoided as much as possible. Cordova was also graced by a system of over 4,000 public markets. The Great Mosque of Cordova, another grand structure, had a scarlet and gold roof, with 1,000 columns of porphyry and marble. It was lit by more than 200 silver chandeliers, containing more than 1,000 silver lamps burning perfumed oil.

The marvellous cities of Toledo, Seville, and Granada were rivals of Cordova in respect to grandeur and magnificence. According to De Fontenelle:

The Moors of Granada, a small black people, burned by the sun, full of wit and fire, always in love, writing verse, fond of music, arranging festivals, dances, and tournaments every day.²

Education was universal in Moorish Spain, being given to the most humble, while in Christian Europe ninety-nine percent of the people were illiterate, and even kings could neither read nor write. You had Moorish women who were doctors and lawyers and professors. Jewish scholars studied under the Moors, and then went to England and set up a scientific school at what later

came to be Oxford University. The Moors furnished the knowledge and the Jews collected it. The Jews were intermediaries. The Moors and Christians were fighting each other and the Jews formed a bridge between them.

The Omayyad dynasty survived in Spain until 1031, but it was obviously in a state of decline by the year 1000. Abd-er-Rahman III, one of the greatest of the Moorish monarchs, reigned for fifty years (911-961), and both stabilized and expanded the territories of his dominions. The Moors were a very tolerant people. The Moorish rulers lived in sumptuous palaces, while the monarchs of Germany, France, and England dwelt in big barns, with no windows and no chimneys, and with only a hole in the roof for the exit of smoke.

In the year 1048, the Emir Yahia of Morocco visited Mecca. Here he met a religious reformer, Ibn Yasin, whom he persuaded to return home with him to teach his doctrines to the Moors. Ibn Yasin with a few followers set his headquarters on an island in the Senegal River in West Africa. The new movement proved to be popular, and the leader named his disciples Morabites (Champions of the Faith), which in time was changed to Almoravides. A crusade was urged by Ibn Yasin, the purpose of which was to maintain the truth, to repress injustice, and to abolish all taxes not based on law. The leadership of the Almoravides, which started in Upper Senegal, was assumed by the Emir Yahia.

After consolidating his position in southwestern Morocco, Yahia died in 1056, and was succeeded by his brother, Abu Bekr, who led his armies to further victories. Abu Bekr retired to southern Morocco and turned over the northern part of the country to his cousin, Yusuf Tachefin, who soon became the master of northwest Africa.

In the year 1062 Yusuf laid the foundation of the town of Morocco with his own hands.... By the year 1082 he had long been the supreme ruler of that portion of the world.... When therefore he consented to cross over to Spain, and in the course of time drove back the Christians and established once more a supreme Sultan upon the throne of Andalusia, his conquest and the dynasty which he founded must be regarded as an African conquest and an African dynasty.³

When Yusuf I crossed over to Europe, he was in command of an army of 15,000 men, armed mainly with swords and poinards; but his shock troops were a 6,000-strong detachment of Senegalese cavalymen mounted on white Arabian horses, said to be fleet as the wind. Once in Spain, Yusuf was met by the chief rulers of Spain: the kings of Almeria, Badajoz, Granada, and Seville. The Moorish army, only 10,000 men in all, joined the African forces of Yusuf and marched northward to join battle with King Alphonso VI, who headed a Christian army of 70,000. The opposing armies battled each other at Zalakah in October, 1086, and at first the Christian hosts seemed to be winning. Al Mutammed, leading the Moslems, had three horses killed under him and,

though wounded, kept his men in line until Yusuf came up with reinforcements and attacked the Christians from the rear.

In the early part of the twelfth century another religious reformer, calling himself the Mahdi, appeared in Morocco. He named his followers Almohades (Unitarians). After the conquest of Morocco in 1147, when the last Almoravide king was dethroned and executed, the Almohades seized the reins of government, and then invaded Europe. By 1150 they had defeated the Christian armies of Spain and placed an Almohade sovereign on the throne of Moorish Spain; and, thus, for the second time a purely African dynasty ruled over the most civilized portion of the Iberian Peninsula.

Under a great line of Almohade kings, the splendor of Moorish Spain was not only maintained but enhanced; for they erected the Castle of Gibraltar in 1160 and began the building of the great Mosque of Seville in 1183. The Giralda of Seville was originally an astronomical observatory constructed in 1196 under the supervision of the mathematician Geber. The Almoravides had established a Spanish court in Seville. The Almohades set up an African court in the City of Morocco; and Ibn Said in the thirteenth century describes Morocco as the "Baghdad of the West," and says that under the early Almohade rulers the city enjoyed its greatest prosperity.

In the early part of thirteenth century, the Moorish power in Spain began to decline. Unfortunately, the Moslems, due to religious and political differences, began to split into factions and wage war among themselves. At the same time the Christians of Europe, having absorbed the science and culture of Moors, which enabled them to bring to an end the long night of the Dark Ages, began to form a united front in order to drive the Moors back into Africa. The dominions of the Almohades were slowly but surely captured by the Christian armies, and after almost a century of brilliant achievement the Almohade dynasty was ended when their last reigning sovereign was deprived of his throne in the year 1230. Moslem Spain declared independence under the rule of Ibn Hud, the founder of the Huddite dynasty. The Christian forces, in the meantime, conquered one great city after another, taking Valencia in 1238, Cordova in 1239, and Seville in 1260.

By 1492, the Moors had lost all Spain except the kingdom of Granada. The Christians, although not free from internal disputes, were finally united by the marriage of Ferdinand and Isabella, which joined in peace the formerly hostile royal houses of Aragon and Castile. The united Christian forces surrounded the city of Granada and blockaded it for eight months. The Moorish king, Abu Abdallah (also known as Boabdil), finally surrendered. The Moors lingered in Spain for a little more than a century. By 1610, through expulsion and migration, a million, among them many Jews, had returned to northern Africa and western Europe. The expulsion of the Moors from Andalusia was a serious setback to modern civilization.

The true greatness of the Moorish culture is not generally known even to

the educated classes of the Western world. The standard work on the Moors is the three volume *History of the Moorish Empire in Europe* by S.P. Scott. One of the very best studies of the contributions of the Moors to world history is the one-volume edition, *The Story of the Moors in Spain*, by Stanley Lane-Poole. It was published in London and New York in 1886. Lane-Poole was English, and was professor of Arabic at the University of Dublin. Of the conquest and expulsion of the Moors, Lane-Poole wrote:

In 1492 the last bulwark of the Moors gave way before the crusade of Ferdinand and Isabella, and with Granada fell all Spain's greatness. For a brief while, indeed, the reflection of the Moorish splendour cast a borrowed light upon the history of the land which it had once warmed with its sunny radiance. The great epoch of Isabella, Charles V, and Philip II, of Columbus, Cortez, and Pizarro, shed a last halo about the dying moments of a mighty State. Then followed the abomination of desolation, the rule of the Inquisition, and the blackness of darkness in which Spain has been plunged ever since.⁴

Some anthropologists have assigned the Moors to an arbitrary Brown race, and others have labeled them *Dark-Whites*. Joseph McCabe once observed that perhaps an African anthropologist would call the same people *Pale-Blacks*. Even the Arabs, who were always a minority in the so-called Arab Culture of the Middle Ages, regarded a dark complexion as a badge of honor. Arnold J. Toynbee noted that: "The primitive Arabs who were the ruling element of the Ommayad Caliphate called themselves 'the swarthy people,' with a connotation of racial superiority, and their Persian and Turkish subjects 'the ruddy people,' with a connotation of racial inferiority, that is to say, they drew the distinction that we draw between blonds and brunets, but reversed the value."⁵ The curious idea that a great white race has been responsible for all the great civilizations of the past is nothing more than a crude superstition propagated mainly by European-oriented racist historians.

Appendix:

Notes on Black Scholars of the Moors in John G. Jackson's Life

In addition to Stanley Lane-Poole and Joseph McCabe, John G. Jackson, in studying the Moors, has relied heavily upon a cadre of extremely dedicated and highly capable scholars. Foremost among these men (unfortunately all deceased) are J.C. deGraft-Johnson, Willis N. Huggins, and J.A. Rogers.

J.C. deGraft-Johnson

The author of the classic work, *African Glory: The Story of Vanished Negro Civilization*, John Coleman deGraft-Johnson noted that, "The conquest of

Spain was an African conquest. They were Mohammedan Africans, not Arabs, who laid low the Gothic kingdom of Spain.”⁶ DeGraft-Johnson was born in Accra, Ghana, on March 21, 1919. Educated initially at Mfantshipim School, Ghana, deGraft-Johnson attended the University of Edinburgh, Scotland, where he was a student from 1937 to 1946. After spending his first two years at Edinburgh studying medicine, he discontinued his medical training to study Commerce and Economics. He graduated Bachelor of Commerce in June 1942, Master of Arts with Honors in Economic Science in June 1944, and Doctor of Philosophy in December 1946. *African Glory*, originally published in 1954, has recently been reprinted by Black Classic Press with an afterword and supplemental bibliography by John Henrik Clarke.

Willis N. Huggins

A brilliant writer and an ardent Pan-Africanist, Willis Nathaniel Huggins was born February 7, 1886, in Selma, Alabama. Willis N. Huggins was one of the paramount figures in John G. Jackson's life. Huggins was the founding father and leading figure of the Blyden Society in Harlem, New York, beginning in 1932. Huggins received a B.A. from the University of Chicago, an M.A. from Columbia University, and a Ph.D. from Fordham University. He conducted further research at Oxford University. In 1934 Jackson co-authored with Willis N. Huggins *A Guide to the Study of African History*, and in 1937 — also with Dr. Huggins — *An Introduction to African Civilizations*. The latter work may contain Jackson's first substantial writings on the Moors.

J.A. Rogers

Joel Augustus Rogers' work on the Moors is perhaps more weighty, certainly more thorough and comprehensive, than any other African-American writer. His finest work on the subject, contained in *Nature Knows No Color-Line*, has yet to be surpassed. A real giant, Rogers probably did more to popularize African history than any single scholar of the twentieth century.

Rogers was born in Nagril, Jamaica, September 6, in either 1880 or 1883. In 1906 he moved to the United States, and spent the major portion of his life in Harlem, New York. Largely self-trained, Rogers was an anthropologist, historian, journalist, and a prolific writer. He covered the Marcus Garvey trial, and though never a member of the Universal Negro Improvement Association, wrote for Garvey's *Negro World*. In 1930 Rogers was elected to membership in the Paris Society of Anthropology. Also in 1930, in Ethiopia, he attended the coronation of Haile Selassie as a correspondent for the *Amsterdam News*. He was also a featured columnist for the *Amsterdam News*.

In 1925 Rogers went to Europe for research in the libraries and museums there. In 1927 he returned to Europe for research lasting three years. He also

went to North Africa during this period. Between 1930 and 1933 he continued his studies in Europe. Beginning in 1935, Rogers served as war correspondent for the *Pittsburgh Courier* during the Italian aggression in Ethiopia. He contributed to such publications as the *Crisis*, *American Mercury*, *Survey Graphic*, and the *Journal of Negro History*. He wrote and published at least fifteen books and pamphlets. Rogers was a field anthropologist; he travelled to sixty different nations. W.E.B. DuBois wrote that, “No man living has revealed so many important facts about the Negro race as has Rogers.”⁷

Acknowledgements

1. James E. Brunson for the photographs in “The Moors in Antiquity,” and also for his assistance and collaboration in several interviews with John G. Jackson.
2. Mr. James Cage for arranging the John G. Jackson interviews.
3. John G. Jackson and the Citadel Press for excerpts from *Introduction to African Civilizations*.
4. Karen A. Johnson for production assistance and proofing in “The Moors in Antiquity” and “The Empire of the Moors.”

Notes

1. Chancellor Williams is perhaps even more blunt about the ethnicity of the Moors. He writes, “Now, again, just who were the Moors? The answer is very easy. The original Moors, like the original Egyptians, were Black Africans. As amalgamation became more and more widespread, only the Berbers, Arabs and Coloureds in the Moroccan territories were called Moors, while the darkest and black skinned Africans were called ‘Black-a-Moors.’ Eventually, ‘black’ was dropped from ‘Blackamoor.’ In North Africa — and Morocco in particular — all Muslim Arabs, mixed breeds and Berbers were readily regarded as Moors. The African Blacks, having had even this name taken from them, must contend for recognition as Moors.” Chancellor Williams, *The Destruction of Black Civilization*, revised edition (Chicago: Third World Press, 1976), 221.
2. Quoted by John G. Jackson, *Ages of Gold and Silver* (Austin: American Atheist Press, 1990), 140.
3. Lady Flora Shaw Lugard, *A Tropical Dependency* (New York: Barnes & Noble, 1964), 55-56.
4. Stanley Lane-Poole, *The Moors in Spain* (London: T. Fisher Unwin, 1887), viii.
5. Arnold J. Toynbee, *A Study of History*, vol. 1 (London: Oxford University Press, 1934), 226.
6. J.C. deGraft-Johnson, *African Glory* (Baltimore: Black Classic Press, 1986), 69-70.
7. W.E.B. DuBois, *The World and Africa* (New York: International Publishers, 1965), xi.

Selected Bibliography

- DeGraft-Johnson, J.C. *African Glory: The Story of Vanished Negro Civilizations*. Afterword by John Henrik Clarke. Baltimore: Black Classic Press, 1986.
- Huggins, Willis N., and John G. Jackson. *A Guide to the Study of African History*. New York: Federation of History Clubs, 1934.
- Huggins, Willis N., and John G. Jackson. *An Introduction to African Civilizations*. New York: Avon House, 1937.
- Jackson, John G. *Introduction to African Civilizations*. Introduction and additional Bibliographical Notes by John Henrik Clarke. Secaucus: The Citadel Press, 1970.
- Jackson, John G. *Man, God, and Civilization*. New Hyde Park: University Books, 1972.
- Jackson, John G. *The Golden Ages of Africa*. Austin: American Atheist Press, 1987.
- Jackson, John G. *Ages of Gold and Silver and Other Short Sketches of Human History*. Foreword by Madalyn O'Hair. Austin: American Atheist Press, 1990.
- Jackson, John G. Introduction to *The Story of the Moors in Spain*, by Stanley Lane-Poole. Baltimore: Black Classic Press, 1990.
- Lane-Poole, Stanley. *The Moors in Spain*. With the collaboration of Arthur Gilman. London: T. Fisher Unwin, 1887.
- Lugard, Lady Flora Shaw. *A Tropical Dependency*. New York: Barnes & Noble, 1964.
- McCabe, Joseph. *The Splendour of Moorish Spain*. London: Watts & Co., 1935.
- McCabe, Joseph. *The Golden Ages of History*. London: Watts & Co., 1940.
- Rogers, J.A. *Nature Knows No Color-Line: Research Into the Negro Ancestry in the White Race*. 3rd ed. New York: Rogers, 1952.
- Rogers, J.A. *Sex and Race, Vol. 1: The Old World*. New York: Rogers, 1967.
- Rogers, J.A. *World's Great Men of Color*, 2 Vols. Edited with an Introduction and Commentary, and new Bibliographical Notes by John Henrik Clarke. New York: Collier, 1972.
- Scott, S.P. *History of the Moorish Empire in Europe*, 3 Vols. Philadelphia: J.P. Lippincott, 1904.

**THE AFRICAN HERITAGE & ETHNOHISTORY
OF THE MOORS:
(Background to the emergence of early Berber and Arab
peoples, from prehistory to the Islamic Dynasties)**

Dana Reynolds

Introduction

Most of us are not aware that the peoples whom the classical Greek and Roman historians called *Berber* were "black" and affiliated with the then contemporary peoples of the East African area. The word *Berber* in fact was used to refer to peoples of the Red Sea area in Africa as well as North Africans. Similarly there was an ancient belief that the nomads dwelling in the same latitudes in the deserts of Arabia were peoples whose ancestors had in times far distant roamed the deserts of East Africa. It was such populations that in large measure comprised the *Moorish* people, but because of the attribute of blackness which sharply distinguished them from the bulk of the European people, the word came to be generally used by Europeans to describe persons of black complexion in general.

The inhabitants of present day Northern Africa are considered ethnically and culturally distinct from the people dwelling south of the Sahara. If this is so, it has only come about in relatively recent times. The 700 years that the Moors dominated the Iberian peninsula was an era during which many people, mostly of European descent, either migrated or were brought to the lands of Arabia and North Africa. Although large numbers of blacks were brought from the Sudan during that era, studies of the slave traffic of that time show that the numbers of people of Slavic and European descent placed into servitude far exceeded the number of Sudanese or other blacks bought and sold by the Moors. The slave trade did not acquire a color until the Portuguese.

This part played by the European captive or slave in the making of the modern North Africans and "Middle or Near Easterners" has been ignored by historians to such an extent that most people are not even aware that such an era ever existed. This is partly the fault of the successors of the Orientalist school. The early "Orientalist" explorers, mainly living and writing in the 18th and 19th centuries and the early part of the 20th, were basically European adventurers. They were usually of the upper-classes, trained in the Arabic language, and familiar with such things as the ancient writings of the classical Roman and Greek historians, the old Hebraic texts and some of the

traditions of Islam. Many of them wanted to believe and tried to prove that the ancient Arab world and "the Orient," especially Egypt, was a primitive form of European civilization and that North African Berbers and the Arabs of Arabia were "noble savages," whose European strain had been reduced by intermingling with ignoble, enslaved "Negroes." Most of them were anthropologists and ethnohistorians.

Some of the later European writers have been a bit more objective in their historical depictions of the ancient world and the world of Islam. According to James Wellard, author of *Lost Worlds of Africa*, Muslim Africans brought millions of European slaves over the centuries into the North African ports of Sale, Tangier, Algiers, Tunis, Tripoli, Fez and Marrakesh and the Northern Egyptian towns. Literally millions were documented as being freed in North Africa by various Christian organizations in Europe.¹ Philip Curtin points out in Ajayi and Crowder's *History of West Africa*, that the majority of slaves being traded throughout the Mediterranean, including North Africa and the Levant (modern Lebanon, Palestine/Israel, West Syria), centuries before the fall of Constantinople when the Black Sea trade was cut off, were of European descent. It is also known that indigenous Bedouin used to come in to slave markets of the coastal cities of Northern Africa and Arabia by way of the desert to secure concubines who were often of European descent.

In 1150 the religious order, the Trinitarians, was founded in France to free Christian Europeans by purchase and, according to J.A. Rogers, "for the next three centuries or more, collections were taken up in the churches for that purpose."²

In *Nature Knows No Color Line*, Rogers also cites notes of Sir Walter Scott on Spanish Chronicles which say that European Christians in Spain were forced to pay tribute to the Moors in the form of women.³ According to another historian, "a veritable terror reigned in the Mediterranean." They ravaged the coasts of Spain, Portugal and Southern France, capturing many. There is apparently documentation of the periodic landing of corsairs along the coastal areas of Europe to take off the entire population of villages. Even in 1721, King George I spoke of "the great number of his subjects" that had been "delivered" into slavery in North Africa. One rather famous Moorish Sultan, Mulai Ismail of Meknes in Morocco, a few centuries ago, had as many as 25,000 European slaves who participated in the building of his colossal stables. Many of the same Europeans brought by the shipload to Africa were then sent to America where they remained in indentured servitude. Scottish mariners, who were often the object of the North African pirates, incidentally, referred to these corsairs as "niggers."⁴ Grafton Elliot Smith, who lived and wrote in the 19th century and early part of the 20th, remarked that "Moor" is often used in Morocco to suggest "Negro" influence.⁵

According to at least a dozen different Greek and Byzantine (neo-Roman) writers, from the first to the sixth century A.D., the indigenous Berber

populations whom they called Mauri or "Moors" were a "black-skinned," war-like, nomadic and predatory population stretching from the borders of Egypt to Morocco. They often lived on the borders of the desert and at the foot of mountains and were said to be accustomed to the usage of horses and camels in battle. At the time of their Islamicization they were bedecked in gold and long robes, armed with javelins, iron implements, swords and shields. (But these are traits which were in fact possessed by many of the nomads of the deserts East and West of the Nile and it is such people who were also known as "Berbers.")

In one of Martial's writings (Satire VI) around the same era we read the phrase "woolly hair like a Moor."⁶ Silius Italicus, an early writer around the beginning of the Christian era, describes the Maures as "Nigra" or black. Corrippus, a 6th century historian in his *Johannid* comedy speaks of their "facies nigroque colorus" and of their blackness as "horrida" or "horrifying"⁷ Procopius, another 6th century Byzantine historian, says the Moors (Maurusioi) were a people composed of a number of "black-skinned" tribes who had gained domination over all of North Africa after the period of the Vandals' ascendancy in Africa.⁸

In that pre-Islamic era, the "Moorish" peoples who were later to invade Spain were, in fact, noted for their skin color. They are described with such descriptive phrases as "black as melted pitch" and "blacker than ink" in certain well-known European epics and histories.⁹ The word Moor had, in fact, come to be used during the Middle Ages for a man of a very dark or black hue, for which reason several authors and playwrights of the period, including Shakespeare and Voltaire, used the term for individuals they otherwise designate as "Negro."¹⁰

The phrase "black as a Moor" was used from Roman times until the Middle Ages. In one manuscript of the 14th century quoted by J.A. Rogers, we read "though men of Nubia be Christians they be as the Moors for the great heat of the sun." The same 14th century observer also refers to the Ethiopians as "Moors."¹¹ The black and woolly-haired Christs sometimes seen in the Iberian peninsula, according to the famous traveler James Mitchner, were referred to as "Moors" rather than as Negroes, which is derived from the Latin *Niger* or *Nigra*.

In modern times it has often been suggested that when the earlier Europeans said "black" or "Ethiopians" in reference to North Africans, they did not actually mean "black" but a dark or swarthy man like certain modern-day North African "Berbers" and many people living in "Arab" countries. This interpretation does not explain the hundreds of jet black men with woolly-hair who appear later in European coat-of-arms and heraldry under the dozens of variations of the term *Moor* in almost every European country. Some of the names under these variants that J.A. Rogers uncovered include such names as Moorhead, Blackmore, Morrison, Murray, Maurice, Mor, Mohr, Morocco,

Moritz, Moran, Maurois, Morini, Moreau, Morelli, Mormand, Moorman, Morenkopf and Swarthmore to name but a few.¹²

Germans even today eat "Morenkopf" candies, dark chocolates shaped vaguely in the form of heads. The word Morenkopf means a Moor's head. All of this is evidence that before the 15th century and the Atlantic slave trade, the word Moor meant more than just a Muslim, Mauretanian, or Moroccan, and was associated more specifically with people of a brownish-black or absolutely black color.

During the Middle Ages masqueraders used to blacken their faces "so they might better pass as Moors" and they would dance such dances as the Morris dance of England and the Moresca (dances apparently named after and derived from the Moors). Another of their legacies in dance is known as *Flamenco Moro*, a dance from which today's Flamenco is derived. The renown of the Moors in the arts was such that a Frenchman wrote in the 1600's, "I can tell from here what the inhabitants of Venus are like; they resemble the Moors of Granada; a small black people, burned by the sun, full of wit and fire, always in love, writing verse, fond of music, arranging festivals, dances and tournaments every day."¹³

The Moors are thought to have introduced the earliest versions of several instruments, including the lute or *el oud*, the guitar or *kithara*, and the lyre. The arts and letters flourished among the Moors in Spain, and they were renowned for their skills and contributions to the sciences and philosophy as well. Rogers mentions certain books, one published in 1610 in which the Spaniards are described as a "white" people being ruled by a "black" one.¹⁴

The word "Moor" signified a black man and the people who were called "Moors" were the North African ancestors of the dark-brown and brown-black peoples of the present-day Sahara and the Sahel, mainly those called Fulani, Tuareg, Zenagha of Southern Morocco, Kunta and Tebu of the Sahel countries, as well as "Moorish" and other "black" Arabs who live in Mauretania and throughout the Sahel. They include the Trarza of Mauretania and Senegal, the Mogharba as well as dozens of other Sudanese Arab tribes, as well as the Chaamba of Algeria. The long, lanky dark-brown men called Tuarek or Tuwareg who can still be seen, veiled and armed with sword and shield, striding through the desert with their camels, are still involved in the desert commerce they were in charge of during the Middle Ages. The copper-black Arab "Moors" are descendants of the Yemenite and Hejazi Arabians, the main bringers of Islam to Africa. They still trace their ancestry to the Yemen (or southern Arabia) and like their kinsmen in Yemen, they can be seen playing "Moorish" melodies with stringed, percussion and wind instruments under shade trees in Mauretania.

The turbaned Tibbu and Zaghawa, jet black and wiry men, once known for their sorcery and their skill in metallurgy, are still spread across the hottest areas of the Sahel and southern parts of the Sahara. The "red" or pastoral

Fulani, renowned for their holy wars, which converted so many Sudanese tribes to Islam can still be seen performing acrobatic dances, the steps and turns of which mirror the "breakdancing," revived by Afro-Cubans in America in the early years of this century.

The haunting music of some of the desert dwellers like the Tuarek and the so-called "Moorish" Arabs are strongly reminiscent of the traditional harmonies heard in the music of Spain and Portugal and has left a characteristically beautiful, equally haunting quality in the traditional folk music of Mali and Islamic Africa in general. Listening carefully, one can discern in their melodies the early blues tonalities of blacks of the American south, and still found in the rhythms and melodies of modern blues.

The Moors founded and constructed many industrious and prosperous towns and cities, in the Iberian peninsula, and all over Northern Africa and as far south as Timbuktu, and other areas of the Sudan, to which many students from other parts of Europe came to study and through which many of the arts and sciences of Africa and Asia were transplanted onto European soil. The remnants of their many castles can be seen in Northern Africa as in Spain and Portugal.

This being said, one does not have to wonder why there has been very little focus in European history on the legacy of the Moors or their influence on Europe's emergence from the Dark Ages. This is unfortunate, for these men and women belonged to a "black" population whose dominance extended from the borders of Egypt to Morocco and the Atlantic, even before the time of the Muslim invasion of North Africa. They are a people whose documented history goes back in North Africa to the time of the Pharaohs and the phase of Carthaginian history that produced Hannibal. Most books that attempt to speak of "Berber" origins (though the Moors were not just the Berbers) claim that they were "whites" affiliated biologically with Europeans like those who live in the Atlas Mountains and close to the Mediterranean today.

The prestige and growing power of Western Europe did much to change the perception of North Africa's original ethnic relationship to groups in the sub-saharan areas. In the 15th century, with the coming of Portuguese and Spanish slave-traders, the earliest of the European slavers (along with the Turks), the slave trade was gradually transformed so that Africans became the vast majority of slaves in Mediterranean Europe, North Africa, and the so called Orient, including the Arabian peninsula. After the fall of Constantinople the Black Sea slave trade was cut off. Turkish rulers in North Africa were inclined to depend on middlemen of the Sahara to bring slaves from the Sudan, rather than to look to Europe where growing technical and military strength coupled with nationalism made slave importation from Northern provinces a far more difficult proposition.

In earlier periods the Berbers had been subject to the rulers of the Sudanese kingdoms but as the era of the Ottoman Turks and the Atlantic slave trade was

ushered in, both Berber and Arab tribes of the Sahara began battling for control over the established trade routes leading to the Sudan. These routes were being fiercely contested because of increasing demand and the payments given for slaves in the trading towns. In East Africa, where both "whites" and "blacks" had been sold up unto a late period, Europeans established themselves as overseers of the trade and helped to make sure the steady stream of African slaves were available for the traders of Yemen and Oman and other parts of the "Arab world."

Slavery was aggravated by the rather distorted demands of capitalism. Rulers in the Sudan were often ready and willing to comply because of the money involved. Apart from this, they conceived of themselves as possessing ethnicities different from the people they sold.

The 18th century saw not only the economic ascendancy of Europe but a great devaluation of African humanity south of the Sahara. And, according to a recent writer, while the Turks, Arabs and Berbers would marry their daughters off to European slaves, marriage to a man of the Sudan, slave or free, was considered denigrating. On the other hand many of the sultans in North Africa and the Middle East had mothers who were Sudanese. (In Europe, too, African men were beginning to be glamorized as exotic "favorites" of noblewomen and African women as mistresses of noblemen and artists.) But, in general, the peoples from sub-Saharan Africa came to be perceived as not worthy of much respect as human beings. The Northern element in North Africa, which by the 18th century was already more European than African or Arab came to look condescendingly on Africa as a place of uncultured peoples, from whence comes the perennial slave or "*Abd.*" It is a perception which has not entirely disappeared among the Westernized peoples of the North African area and the Middle East. These negative perceptions have recently been intensified because of the way "black Africans" or people of African descent are portrayed in the Western media and in scholarly publications.

It was after the late era of the slave trade that there came to be a penchant for using words other than Moor for the Africans who were then being taken into Europe in servile status, for Moor had previously denoted one of the more admired and markedly empowered peoples of Europe. (In fact General Franco of Spain used troops very black in color who were called "Moorish.")

This necessitated ignoring the ethnic heritage and history of the men called Moors who were in fact people called in ancient times Berbers and Arabians. One is led to believe from recent writings on "Berbers" that they were hordes of tanned "European-looking" men with no affiliation to the "black-skinned," lightly built, Africans that the ancients said they were. Instead we are told they were Africans of the "white" race which "semi-white" men of the "Orient" had converted to Islam and led into Portugal and Spain.

The Arabs of that era were also mostly Bedouin, who brought the language

and beliefs of their ancient desert culture and some of the complex cultural traditions of ancient Arabia and parts of Asia into North Africa. The Berbers were the aboriginal indigenes of Northern Africa (mostly desert and mountain dwellers who belonged to a type that predominated in the same latitudes as those of the Arabian peninsula) as well as further North and East in Asia, centuries before Islam.

Ancient Arabia was occupied by a people far different in appearance than most of its modern-day occupants. These were a people who once occupied Egypt, who were affiliated with the East African stocks, and who now speak the "Hamitic" or Semitic languages. These were the people who, in the days of the Romans, were the majority of the occupants of the Arabian peninsula.

Waves of colonizations by Romans, Greeks, Turks, Iranians, Iraqis and others combined with the Europeans to bring about the gradual modifying of the physical appearance and culture of the people in the areas of North Africa closest to the Mediterranean as well as the people who populated the Arabian peninsula. The West has played down, ignored or completely denied the role of colonization, slavery and concubinage in the creation of the population in coastal cities of North Africa like Cairo, Tunis and Algiers. This population is phenotypically similar in many respects to those areas on the opposite side of the Mediterranean in the southern portions of Europe. European academia has usually preferred to see this demographic phenomenon as testimony to the "Caucasoid" or European origin of such peoples as the ancient Berbers, Moors, and Egyptians.

It is because the original populations have since been overwhelmed by others biologically and culturally, that few Westerners have written of the ethnic heritage or contributions of ancient cultures of North Africa, whether in Egypt or Tunisia or Morocco, in the context or terms of their real or "black" African background. They have chosen to concentrate on the most recent world of the Arab and Berber-speaking peoples and present it as if it is a world that has always been. It is like comparing the Aztecs of five hundred years ago with the ethnic mix of America today. The story of when North Africa was Moorish and Arabia the land of Saracens has yet to be told.

The following essay will try to present the evidence which demonstrates the biological and ethnic ties of the ancient Moors with other indigenous "blacks" of Africa.

* * *

The Arab as Known to the Greeks and Romans

In the days of Mohammed and the Roman colonizations of Palestine, North Arabia and Africa, the term Arab was much more than a nationality. It specifically referred to peoples whose appearance, customs and language were the same as the nomadic peoples on the African side of the Red Sea. In fact, the term included the populations of the Red Sea in Africa. Some now think that the word Arab is a word literally meaning nomad, although the word has never been used to refer exclusively to nomads. (According to ancient southern Arabian inscriptions the word *Arhab* or *Arribi* was a name of one of the Himyarite tribes of the Yemen in the Bab el Mandeb area.)¹ Before the spread of Islam, there lived in the deserts of the Arabian peninsula, Northern Syria, Iraq and Hadramaut, nomads who were nearly as "black" as the Moors they later conquered and converted to Islam. Because the word Mauri had come to signify a man of black or nearly black complexion, the Arabian who invaded Northern Africa came also to be referred to as "Moorish."

These lesser modified occupants of Arabia were and are described in Arabic as "hadhara" or "black."² This word originally signified that which is like the color of a type of iron which was greenish black. Thus, such things that are black or very dark like iron, or like the night, are often described in early Arab writings as "hadhara" which literally means "green" but signifies something black. The peoples of Chad, until the Europeans colonized the area, sang of Tunis, the "hadhara," in memory of the presence of the dark-complexioned Arabs who once ruled there.³

According to Ammianus Marcellinus, Roman general of the 4th century A.D., the Bedouin populations of southern Syria and the Arabian peninsula, whom the Romans called Saracens (derived from Sarah or Sahra meaning desert nomads), were peoples "whose primary origin was derived from the cataracts of the Nile on the borders of the Blemmyes." The Blemmyes or Bedja are a people located then and now in the deserts east of the Nile in Sudan.⁴ They rode on camels and like the Moors were particularly notorious for their hit and run raids from the desert fringes. They were lightly clad, dressed in tunics only to the waist, and were experts at pillaging for which reason Ammianus claimed they were "not good to have as friend or foe."

A stratum of peoples of relatively recent African origin extended into Asia. The evidence of linguistics, archaeology, physical remains and ethnohistory support the observations and descriptions we find in the histories of the Greeks and Romans and in later Iranian documents about the nomadic Arabians of that early era. The Arabs were the direct progeny and kinsmen of the dark-brown, gracile and kinky haired "Ethiopic" peoples that first spread over the desert areas of Nubia and Egypt. Before the middle of the 2nd millennium they were located along the Mediterranean coast in Turkey, Europe and the Arabian peninsula. In their least modified form they may be found now settled in the Horn of Africa, the southern Sahara and remote parts of Arabia.⁵

These people spoke languages belonging to a group that linguists now call Erythraean or Afro-Asiatic (formerly called "hamito-semitic"). The dialects are spoken predominantly in the Horn of Africa, North Africa and the Middle East. They include the dialects called Cushitic, Omotic, Ethiopic or Ethio-semitic. The latter grouping is descended from ancient dialects of Arabia which in turn have their roots in Africa. In North Africa the dialects include the Berber and *Arabic* (which is a late comer to Africa and the last evolved of the African-Asiatic dialects). They also include the ancient Semitic dialects of Syria and Mesopotamia as well as the language of ancient Egypt which some scholars considered to be "proto-semitic."⁶

The early Semitic dialects include those called Akkadian, Amorite, Aramaean, Canaanite, Hebrew and South Arabic. The language of the original Semitic speakers, however, was also adopted by other North Syrian peoples indigenous to Asia. These latter seem to have been predominantly fair-skinned, broad-headed, prominent-nosed people who came to predominate in Northern Syria, Northern Armenia and Mesopotamia, especially those populations of the areas anciently called Assyria and Ebla. They were in custom and origin much different from the people of the desert, who could claim an African origin when the Romans fought them in Syria and Arabia centuries after Christ.

Some of the most prominent linguists today have suggested that the Semitic languages and culture originated in Ethiopia and spread from there to South West Asia.⁷ It was long ago pointed out that Egyptian seemed to be a proto-Semitic dialect and that the Cushitic languages of the area of Sudan and Ethiopia possessed the seeds for the Semitic dialects. And although modern Ethio-semitic dialects seem to be descended from those of the Abyssinian, Sabaeen and Himyaritic immigrants who colonized parts of Ethiopia and Somalia about 500 B.C., recent studies show that Semitic languages have been spoken in Ethiopia for at least four thousand years.⁸

Rock art and the stone or lithic industry of the Rub-al Khali or Empty Quarter (Central desert in Saudi Arabia) seem to point also to Somalia and the Horn of Africa as the area from which a wave of sheepherding people emigrated to Arabia during the period between 5,000 and 4,000 B.C.⁹ The people portrayed in this art have been described by Emmanuel Anati, an archaeological specialist (who has written on the drawing) as "Negroid." The extent of this rock art, however, stretched to the Persian Gulf area in the east and has some affiliation with certain early cultures of Mesopotamia. The art also shows some elements of similarity with rock art of the Chalcolithic period in the south Syrian desert and the Gerzean paintings in Southern Egypt.¹⁰ One early specialist in Egyptian rock art and glyphs suggested they were essentially the same as the art of peoples dwelling in the hills and deserts East of the Nile.¹¹ Similar depictions of dark-skinned men and other elements reminiscent of the early predynastic Egyptian culture appear in the Jebel Kara

area where several of the tribes still resemble the peoples of the Nubian desert called Beja as well as other Cushitic and Ethiopic-speaking peoples in Ethiopia, Sudan and Eritrea.¹² The Shahara or Sheheri whose name was made famous through the story of Sheherazade still live in Jebel Kara and the hills of Dthufar in Oman. These Afro-semitic people, according to Sir Richard Burton the famous "Orientalist" explorer, are a people with low brows and black skins, with frail and slender frames. According to Bertram Thomas these people, who speak some of the oldest living Arab dialects, resemble the Cushites called Bedja, now living in the deserts east of the Nile in Sudan and Ethiopia. Such people appear in isolation further to the North of the peninsula as well as in Iran where they apparently called themselves Lam.

The men in the Arabian rock art wore small beards like those in Sahara rock art. They also wore headdresses and used throwing sticks. The ostrich, the shield, the staff and the phallus are often portrayed. These were apparently sacred symbols which often have totemic significance today among pastoral people in Africa especially in the Sahel and Cushitic areas. They carried on ceremonies, associated with the ox and the phallus. They practiced mock battle similar to that of the Cushitic and the Nilo-saharan peoples of east Africa. The men portrayed in the art of the Arabian desert, in fact, bear great resemblance to the slender and lightly bearded nomads which appeared in the same epoch in the Sahara.¹³

G. Elliot Smith, who early recognized the ancient prevalence of the "Erithraean" or "Abyssinian" type of man in the Near and Middle East which he named the "brown race" was a specialist in physical anthropology and had studied the osteological remains of the Middle East and Africa. Smith asserted that there was good reason to believe that the early inhabitants of Arabia and southern Syria were essentially the same, osteologically speaking, as the A-group population of Nubia. He was also adamant about his belief that the modern Cushitic speakers of Ethiopia and the early inhabitants of ancient Egypt were genetically related.¹⁴ Though still inhabiting the southern deserts and some of the mountainous areas of Oman, these slender "dark-brown" pastoral tribes are not very numerous in Arabia today. It is this small, African type that Kramer, the founder of Sumerian studies, talked about when he spoke of the "brown" man that occupied Sumer.

In Jebel Djezan, in modern day Saudi Arabia people indistinguishable from modern Eritreans live. The houses they build are also similar to those found in Eritrea. In modern day Yemen live the Murad mentioned as a Himyarite tribe in early inscriptions. Several other tribes of this ancient Afro-semitic stock still dwell in the desert and coastal areas of the peninsula. Their customs in many cases are like those of the Abyssinians.

Such types in Arabia are represented in tribes like the Harb who dwell North of Mecca. Not long ago Sir Richard Francis Burton in his travels to Arabia met men from the Harb tribe, who were the ruling clan of the Hejaz.



Figure 1. Girls of Yemen in Arabia, the ancient home of Sheba (Saba) and the Himyarites.

He describes them in the personal narrative of his pilgrimage to Mecca and Medina as having attenuated limbs, a "chocolate brown" color and "bushy hair" with "screaming voices." He called them the ruling clan of the Hejaz area which is the area of Mecca, the early Muslim town. The Harb, who dwelt in the Northern Hejaz when visited by explorer Burton, are by tradition the descendants of the Ghassan or Assanite Saracens described by Roman writers like Ammianus Marcellinus. The Hamida, the largest clan of the Harb, are mentioned in ancient South Arabic inscriptions. Hamida are also found in modern Sudan.

The Beni Harb, according to Arab genealogy, were also related to those Arabs that invaded North Africa in the 11th century called Qays, Ailan, Suleim and Hilal. Thus it was that a few centuries after Ammianus Marcellinus wrote, men of this sort proclaiming themselves followers of Mohammed left the Arabian peninsula, the area of the Hejaz and Yemen, lands which they had inhabited for some 4,000 years. They invaded the countries to the North and North East of them, turning the speech of those lands to the speech that is called Arab, and the culture of those lands in part to the Afro-Semitic culture. Ever since then most Muslims who speak the language of the "hadhara" Mohammedans have been referred to as Arab.

In the 1500s, Jews called Anaiza lived in the hills of Khaibar (ancient capital of Judaism in Arabia). They are now found in both North and South Arabia and were described by an Italian explorer as "black, though some are blacker than others," with voices like women. They "flayed alive" any Muslim who came within their midst.¹⁵ They are by tradition descendants of those who fled Judaea at the time of Bukht al-Nasur or Nebuchadnezzar, the Chaldaeo-Babylonian king who invaded their land.

The early desert populations of Arabia and Africa were for the most part derived from Africans who seem to have undergone a specialized physical development having evolved in hot, dry regions in the late stone age. Many of the Eritrean-looking men of Arabia and those in Africa, inappropriately named "hamites" by European academia, are often found in areas where temperatures soar above 120 degrees. They tend to be very slender with gracile bones and attenuated limbs. The skin, though dark-brown or black-brown, tends to have a strong reddish hue, which is thought, also, to be due to the ecological pressures of the environment in which they evolved. Long and narrow pentagonal-shaped faces are common. Narrow noses and little or no prognathism are typical and associated with the modified aspect of their facial and cranial morphology. These characteristics, once presumed to be a legacy of a non-Negroid or Caucasoid intermixture, are now attributed, by some population biologists and geneticists, to the ancient adaptation of Africoids to certain specific, ecological factors including the change to a neolithic diet in combination with dwelling in exceedingly hot, dry habitats.¹⁶

Thus the indigenous or "black" tribes of Arabia were those who in ancient

times emigrated from Africa during the neolithic era, approximately four to five thousand B.C., and were the earliest purveyors and dispersers of the semitic dialects especially of the early semitic which prevailed in the area of Syria and Mesopotamia as well. This is to say, the "Saracens" that Ammianus Marcellinus saw were dwelling in Arabia for at least three to four thousand years before he encountered them. They were not only familiar with the desert but had been involved in the creation of some of the earliest so-called "semitic" civilizations.

Some like the Thamudeni or Temai are mentioned as desert dwellers in Assyrian texts of the 7th century B.C. They are mentioned along with a tribe called Sabaai, who were in fact the Sabaeans of southern Arabia and Macae who were perhaps the Macae Saracens of Mesopotamia mentioned by the Romans of centuries later. Their cattle and camels were "without number."

The Agareni or Hagar whom Ammianus, St. Jerome and others spoke of, were probably the same tribe mentioned thousands of years earlier in an inscription of the Persian Gulf area on an island called Dilmun. There were those of the Saracens who had emigrated North from the southern parts of Arabia after some ecological catastrophe had caused the breaking of the dam in the Sabaean civilization. Such people were the Assanites or the "hadhara" Ghassanids and Lihyanites of early texts. Others like the Nabataeans of Petra were in fact known as Amorites until a late period. By Arabic historical tradition they were descendants of Nimrod and Kush who were said to have come to Jordan after having left the Chatt el Arab area of present day Iraq or what was then known as Babylon.

It must be said here that early Greeks and Romans did not usually distinguish ethnically between the people called Saracens and the inhabitants of southern Arabia (the Yemen) which was called India Minor or Little India in those days, nor southern Arabians from the inhabitants of the Horn of Africa. What differences there were between them were more cultural and environmental than anything else. Strabo, around the 1st century B.C., Philostratus and other writers, speak of the area east of the Nile in Africa as "Arabia" and the people are persistently and indiscriminately and sometimes simultaneously referred to as either Arabs, Indians or Ethiopians, just as native Americans in Central and North America are characteristically grouped under a single term as "Indians." Strabo even went so far as to say that the peoples called "Trogodytes" the indigenes of the ancient Horn should not be called "Ethiopians" as they were really "Arabs."

Although the ancients were aware of the movement of peoples like the Habeshan (Beshmat) and Sabaeans from the Arabian peninsula to the Horn a few centuries before the Christian era (a movement fairly well-documented by archaeologists), it is clear from the ancient writings on the "Arabs" that the peoples of the Arabian peninsula and the nonimmigrant, indigenous nomads of the Horn were considered ethnically one and the same and thought to have

originated in areas near the cataracts of the Nile. Trogodytes (Bedja) were said to have lived on both sides of the Red Sea.

Several southern Arab peoples like the Himyarites of Yemen who are sometimes referred to as Ethiopians and the Maddeni or Madiei of the Hejaz Asir were considered Saracens by Procopius. Such people had strong commercial ties with Africa through the Red Sea trade. It is hard to imagine that the people on the Arabian coast on the eastern side of the Red sea called in ancient inscriptions *Madiei* were not in some way related to those men called in ancient times *Madjai* or *Madjayu* (the Egyptologists' rendering of the name) on the western or African side of the Red Sea. The Medjayu are mentioned before 2,000 B.C. and appear as late as Roman times in Egyptian texts as truculent desert nomads. They are presently considered to be ancestral to modern Bedja or Cushites. The latter (Madjai) carried on a great caravan trade with Egypt as late as the days of the Romans and the former (Madiei) were considered incense traders. According to Josephus, Cleodemus and later writers, a Madan gave birth to the founders of tribes called Afran or Afra, and Abida and Hevila, Iudadas and Raama whose descendants crossed over into Libya. In fact, these could be none other than the Abida, Afren, sons of Midian of Genesis fame. Josephus makes Madan, the brother of Midian, father of the two tribes.

According to later traditions, Afra also known as Ifrikus or Fariq crossed over the Nile and conquered the indigenes of North Africa, founding many tribes of Berbers and naming Africa. Interestingly enough, the tribe of Abida inhabits the south Arabian area and directly across from Yemen in the Horn of Africa, a Cushitic tribe called Afar dwells in Djibouti and Erithraea. Avalis or Hevila was known as the country of the Trogodytes and is now known as Zeila. It is located in modern Somalia. (More will be said about these traditions and the Trogodytes and the Bedja later.)

The Berbers of the Romans

The word Berber is utilized to describe present day inhabitants of North Africa who speak a pre-Islamic North African dialect. They represent a highly amalgamated peoples varying in appearance and morphology. Modern day "Berbers," however modified by racial intermixture, still speak a language related to other indigenous dialects of Northern and Eastern Africa. Their language has been suggested to have some Semitic elements and Indo-European words as well. But while many of the modern day tribes denoted by scholars as "Berbers" have a strong "Caucasoid" element biologically-speaking (especially those in the northern regions of North Africa), the ancient Berbers were evidently more African than they were European and as such, were often spoken of as "Ethiopian."

Words like "hamite" and "brown" or "gracile Mediterranean" have been

employed by anthropologists to describe both the indigenes of Ethiopia as well as the very hybrid populations of modern day North Africa. Such terms, besides tending to hide the fact that modern Berber-speakers are a product of amalgamation mostly recent, also belie the fact that the original Berber and Arab populations in North Africa were biologically and ethnically affiliated with modern day peoples to the south of Egypt especially those who now speak languages of the Ethiopic and Cushitic groupings.

The name *Maure* as has been said was first used for one of the several dozen "black" tribes that occupied North Africa even before the Christian era. The tribe itself included several clans including Mauri Mazazeces, Mauri Baueres, Mauri Bagoda and Mauri Gentiani.¹⁷ It is one of these clans—the Baueres or Bavares—whose name was frequently amended to Barbares or "Berbers" in the ancient Roman texts.¹⁸

Claudian, a prominent Roman of the 4th century A.D. complained about Gildo, the Moorish ruler in Algeria, claiming that in handing over Roman matrons of Sidon to his fellow Moorish countrymen, he made "hideous Ethiopian hybrids" affright the cradles of Roman provinces of North Africa. One of the culprits he names in this regard are the Berbers. (Gildo himself was one of the Baueres).¹⁹ The use of the term Berber in this paper will thus be for the original indigenes of North Africa known simultaneously as "Moors" and "Ethiopian" who were the "wandering Libyans" spoken of by Herodotus and the descendants of Danaus and the "black Danaaides" of other early Greek writers.

On the Origins of the term Berber

There are many instances in ancient classical literature where names of foreign tribes "were caricatured into punning words intelligible to Greek audiences." The word *Berber* seems to be one of these. The term has often been considered to mean "barbarian," but, as G. Camps points out, the word *Barbares* or *Berber* in manuscripts was different from the normal plural meaning "barbarian" which was *Barbari*.²⁰ This is one of the main reasons for considering the word Berber indigenous to the Africans themselves. G. Camps and others have also mentioned that the term *Berber* appears sporadically in the toponyms of the "hamitic-speakers." The linguistic grouping formerly called "Hamitic" by scholars included various dialects of the Cushitic and Omotic branches in East Africa besides the Berber and Chadic dialects and ancient Egyptian. The term Erythraean and Afro-Asiatic is now utilized for these and the related semitic languages.

If, as is now presumed, this linguistic grouping had its beginnings in the eastern Sudan, then we can assume that the root *bar*, *ber* or *bur* signified what it does now among such peoples as the Berbers and Cushites in Africa which is the phallus, young man or a warrior. In modern Cushitic and Tamashek

(Berber), and other groups of the Afro-Asiatic dialects—the word and roots pronounced *barbariyiha*, *bur* or *bar* mean a male youth or warrior or sometimes the phallus. It reflects the importance of the warrior caste or age-set among such peoples, as seen in the importance of mock ritual battle and ancient phallicism in Cushitic, Semitic (Canaanite) and Berber culture. Otherwise, the more likely significance is that it has something to do with the word for wells and water sources which are so important in the lives of pastoralists. This would more adequately explain why the word appears in “hamitic” regions as a place name. Berber was the name for the people and region of the Red Sea coast. Part of this region is now called *Behera* or *Bahr Ge'ez*. The word *Behera* refers to the sea.

A man named Berr, according to one tradition, was ancestor of the Berbers. The name of the hero-ancestors of the Berbers, the 7 Iyyabaran or Jabarran (otherwise called Argulen), like the Jababirah of Arab tradition is probably affiliated to this name.²¹ Many Cushitic and Berber tribes, ancient and modern, had names prefixed or suffixed by variants of the root *ber* or *bar*, *bur*, *war*. (In ancient times we have such tribes as the Sababares, Megabari, Adiabari, Nahabari, Sambaridae in the area of Nubia and North Africa). The language of certain “hamitic” peoples now living in Chad of Cushitic origin is called Barituki meaning belonging to the Baribari. In Arab writings we have the Berber names Warfejun, War Satafa, Wargla and Warith.

It was just mentioned that the term Berber was also used by the Romans for the people of the Somali coast and certain nomadic peoples of Nubia and the eastern desert. Large areas around the Red Sea are called in ancient maps Berbera or Barbarioi. The area extending between Berenice and down to Adulis in Ethiopia was Berber country and the Somali coast was called the other country of the Barbarioi.²² The term was seemingly always employed in East Africa for these nomadic and desert peoples otherwise called “Trogodytes.” It was never used for the peoples of other sorts of African cultures whom Strabo and other ancients assure us were in the area. All this makes it by no means improbable that the word stems from the Africans themselves and that the appropriation of the term by the ancient Greeks and Romans led to its coming to be imbued by modern scholars with the significance of “barbarian.” This is not to say such people were not considered barbarian by the Greeks and Romans.

The Libyans and Moors (as seen by the Greeks and Romans)

The early ethnohistory of the North Africans and the emergence of the Islamic Moorish dynasties has been fairly well-documented by the works of Arab historians and earlier manuscripts. The tribes who comprised the Moors were apparently in many cases identified by the same clan names as they were known in the area of Carthage and Numidia in the centuries before the

Christian era. Although some modern Berbers are neither fully African nor European in appearance, several tribes have changed very little and the adjective “Ethiopian” can just as well suit them today as it did in ancient times. (See below)

The word Lebou or Libyan was one of the earliest terms for the black or dark-skinned indigenes in North Africa before the time of the European colonizations. Oric Bates, a scholar familiar with the archaeology and ethnohistory of ancient Northern Africa, noted in his book, *The Eastern Libyans*, that all of the oldest representations of the Libyans in Egyptian iconography show dark brown-skinned men.²³ Only in later times, after the 12th dynasty, do the paintings show other types under the same terms. Among the most common names for the Libyans in ancient Egypt are Tehenou, Temehou and Lebou. Another scholar more recently places the first appearance of blond Libyans under the name of Temehou during the time of Seti of the 19th dynasty. The name Temehou previously referred to a land located to the west of the Nile in what is now called Libya and Sudan.²⁴

It seems the migrations of “the peoples of the sea” coming from areas to the North of the Mediterranean sea and the isles of that sea had led to the settlement of people related to Scythians or the later Hellenic Greeks in the areas of the African Libyans.²⁵ The Egyptians came to utilize the terms Lebou (Libyan), Tamehou and other originally ethnic terms in the sense of “westerner” and thus many types of peoples of differing origin who came to inhabit the area of modern Libya were represented under terms formerly denoting the “Ethiopic” or “Hamitic” indigenes.

For the Greeks and Romans Libya became the ancient name of the whole of North Africa. They were well aware of the presence of foreigners or colonists in North Africa from Asia Minor who were descended from Scythians and Phoenicians. However, they recognized an indigenous and relatively homogeneous group of Libyans whom they spoke of in their allegories as the descendants of Danaus and the Danaides and a “Nile-born” Epaphus, described as black in ancient writings. It was this sort of North African who was most often referred to as “Libyan” by the Greeks and Romans and it is they who were the ancestors of the “Maurusioi” or “Moors,” among whom were the *Berbers*.

Being Africans and closely affiliated with pastoral groups further east, they were a people whose customs and religion were almost entirely African at the time of the first encounter with Roman colonists. They scarred and painted their faces like other Africans. They wore their hair in totemic styles and braids. They did not eat of the flesh of cows as is the custom of many of the more traditional Cushitic peoples today.²⁶

Some of the “Libyan” tribes that are mentioned by Herodotus are the Nasamones, Gindanes, Machlyes, Gamphasantes, Gilligammae, Psylli, Atlantaeans, Lotophagii, Macae, Adyrmachidae and Auseans. The

Adyrmachidae were directly West of the Egyptian Delta in Herodotus' day although they are described a few centuries later as a people along the Nile in Northern Nubia, the Nasamones were in Syrtis Major (see map) across the southern slope of Cyrenaica in modern Libya. The Nasamones controlled the Augila oasis in Libya, the Macae were directly West of the Nasamones, Machlyes were in the Lesser Syrtis on the Libyan coast, the Lotophagii were in the west of Libya and the Gamphasantes were considered a section of the Garamantes who were more or less agriculturalists and pastoralists in the Fezzan area. The Ammonians were a sedentary people in the Siwa oasis in Libya and partly Egyptian.²⁷

Later ancient writers mention many other tribes. They include people like the Marmaridae, Zigritae, Maures, the Lagwathes or Levathes who were a tribe of the Maurusioi (Moors), Mazikes another Maurusioi people, the Pharusii of southern Morocco, the Erebidae, Tedamansii, Asbstae, Hesperidae, Nigritae, Gaetuli and a host of other peoples. According to Strabo of the 1st century, the Marmaridae lay along the shore next to Egypt extending west to Cyrenaica and south to Ammoniam (Siwah). The Hesperidae lived in the fertile part of Cyrenaica. According to Philistus, the Erebidae and Gindanes were part of the Lotophagii. The Levathes Maures were in Leptis Magna at the time of the Emperor Justinian of the 4th century. Salluste a few centuries earlier calls the Maures a people in the area closest to Spain.

A people called Gaitules were said by Eustathius to be the greatest or largest of the Libyan tribes. According also to Strabo they were the most numerous. They extended along the south Atlas slopes eastward to the Syrtis Major. They composed a number of sub-tribes including Nigize, Baniurae, Bagigaitules, Darae and others. It is possible that they were also the Atlantaeans of earlier writers.

Pliny and Tacitus mention tribes like the Mussulini or Massyli, and the Masaesyli who were possibly the Macae Libyans mentioned by Herodotus. Ptolemy mentions the Seli, a tribe next to the Nasamones. Bates thought that the root Sel was an ethnic term preserved in the names like Psylli, Massyli and Masaesyli.²⁸ (Zel, Jel or Kel is a modern Berber root meaning clan.). Procopius implies that these Masaesyli, and Massyli who lived in the ancient kingdom of Numidia were Moors and Gaitules trained by a leader named Massinissa to be soldiers.²⁹

The Luwata were a prominent tribe mentioned in Arab writings. They were the Levathes or Ilagwathes and Leucada spoken of by Procopius and Corippus and others. Corippus of the 6th century A.D. who speaks of the Lagwathes says that among them were a pitiless tribe called Ausuriani otherwise called Astures or Astacures.²⁹ They also lived in Ethiopia.³⁰ The Luwata had several sub-tribes, including Mazikes. Procopius says that they were a tribe of the Maurusioi who occupied the area of Tripoli and Tunis while other Maures lived in Byzacium and Numidia. *The Moors were said by Procopius to have*

colonized parts of the Iberian peninsula over a thousand years before.

The Libyan races shared various customs some of which were admirable while others inspired less appreciation. They were, like the men and women of Arabia, accustomed to raiding and pillage especially from the desert fringes. The historian Diodorus in the 1st century B.C. spoke of the Gaitules as a people who made robbery their constant practice, attacking unexpectedly from the desert. Nonnus calls the Maures a people of the desert "stung with mad lust of robber welfare." Tacitus describes the Garamantes as an ungovernable tribe "always engaged in practicing brigandage on their neighbors."

Another custom shared by the Libyans was the penchant for dwelling in caverns and grottos. Pausanius said that the Libyans lived in huts and in natural caverns and in man-made grottoes. Such people were found among the Gaitules and Pharusii. Strabo said that certain of the Pharusii, then in southern Morocco lived in grottoes that they built. Such people in "Arabia" and "Ethiopia" east of the Nile were named Trogodytes. Herodotus mentions that the Ethiopian Trogodytes also lived in the Fezzan area of Libya. The Mauri Mazazeces or Mezikes in the area of Tripoli and Tunis were called "Ethiopians" in an ancient roman document entitled the *Exposition Totius Mundi*.³⁰ It is these Maures who composed the African or Ethiopian luxury slaves as Rome, where they were called Amazegzeg and Amazik.

The lifestyle of the Libyans and their appearance apparently differed little from those nomadic peoples east of the Nile. Strabo who lived between 63 or 64 B.C. and 23 A.D. spoke of the Maurusians as a people who braided their hair, grew beards, wore hair ornaments, paired their nails, fought mostly with javelins, rode bareback and wore skins of leopards and lions. He said that they dressed like their neighbors, the Masaesyli of Numidia, and like most of the Libyan tribes in general.³¹

Later the Moors are described by Procopius as a people "who lived in huts and wear a thick cloak and a rough shirt at all times. They also had camels, shields, javelins and swords." The men wore earrings in one ear. They dwelt in Byzacium, Tripolitania and Numidia and their women uttered oracles in trance-like states and foretold the future.

Mauri Gensani or Quinquegentiani are mentioned as nomadic tribes between Barka in Libya and the Shotts region of Algeria. The later name for the Maures of Barka are Luata (Levathes or Ilagwathes). Corripus mentions them in the 6th century as carrying a long sword with a short sword attached to the arm.³² It is the custom of modern Beja and other Cushitic and Nilo-saharan speaking tribes of the Eastern Sudan to carry these arm or wrist daggers and at times long swords.

The Maures are also known to have been ruled by female chiefs, holy women or queens even in the time of the Islamization of North Africa. Procopius mentions that they often rode in chariots into battle with the men, helping them with their arms of iron. The original Amazons were said to have



Figure 2. The Tamahou portrayed here in an ancient Egyptian tomb painting are one group of early Libyans. The first mention of them was in the northern part of the country now called Sudan near the area still called Tama Wadi Howar). The early Libyans controlled a caravan route running from Darfur in modern Sudan to Northern Libya passing through the different oases in the Libyan desert west of the Nile. Men in Northern Sudan still wear the famous Libyan sidelock.

been Libyan women and the war Goddess Athena was supposedly from Libya. Diodorus Siculus wrote about the Amazons in the area of Hespera "it was the custom for women to practice the arts of war and to serve in the army for a fixed time...and if it happened that a girl was born, its breasts were seared that they might not develop at the time of maturity; for they thought that the breasts, as they stood out from the body, were no small hindrance in warfare."³³ Two different European missionaries in 16th century Ethiopia describe this same custom among certain tribes there. Of the young girls it was said the elders seared off one of the breasts with a hot iron while they were young, in order not to impede drawing the arrow. They rode on camels and were great archers.³⁴

Saharan rock drawings seem to display women with a single breast. Herodotus had spoken of a custom of the women of the Libyans called Auseans who had a kind of ritual fight with stones and clubs in honour of Athena or Minerva. The girdle of Athena, according to him, was taken from the goat skin or aegis worn by the Libyan women. This is worn by Ethiopian women to this day.³⁵

Between the sea and the Gaitules, extending from the Atlas mountains to the Syrtis Major in Libya were men "with many wives and children" who "in many respects were like the nomadic Arabians." They are described as plaiting their hair, polishing their teeth, filing their nails, wearing gold ornaments and they rarely touched one another as they walked "so that they wouldn't disturb the arrangement of their hair which held totemic sanctity. "They followed horse breeding with exceptional interest."³⁶ A very similar description is given of the Nasamonians in Libya by Gabrinius within the same century. "They wear gold ornaments, they polish their teeth and file their nails. We very seldom see them touch one another as they stroll around for they do not like their hair dressing disturbed. Their horse-borne warriors have spears and swords, they wear unbelted robes and some use war chariots. They have many wives and children and resemble the wandering shepherds of Arabia."³⁷ But instead of "plaiting" their hair, "they curled it." (Curling the hair with hot irons was a practice of the Nubians as well). The Nasamonians foretold the future by going to lay on the graves of their ancestors.

The semi-nude and completely nude state was a mark of the Libyans at the time of Christ. Nasamonians were seen nude as often as they were seen in robes. Garamantes and Pharusii were described as a people wandering about half-nude and nude which is how the Libyans were often portrayed in early Egyptian iconography and Saharan rock art. The Garamantes, Nasamonians, Pharusii and Maurusioi were accustomed to using small war chariots as well as four-horsed chariots.

Thus the early demographers in the first few centuries A.D. commented on several facets of the lifestyle common to tribes located in North Africa under various names. These traits included their preoccupation with desert raids,

horse rearing, hygiene and hair dressing, their access to gold and its usage in accessorizing their dress, their “polygamous” social relations which the Greeks interpreted as a form of promiscuity and the social status and liberty of Libyan women and their resemblance to the wandering tribes of Arabia.

The last but certainly not the least important of the distinguishing features which the early Greeks and Romans ascribe to the Libyans is a black complexion which was sometimes said to be accompanied by a reddish cast. All of the most important Libyan tribes are described as black-skinned. Martial, Corripus, Procopius, Juvenal and Silius Italicus refer to the Maures as black-skinned.³⁸ Polemon in his *Physiognomical Scriptures* and Admantius “confused” the Libyans with the Ethiopians because of their like color.³⁹ They were also at times described as “light of build” and “woolly haired.”

The predominant type in ancient East Africa, like those of ancient Nubia, Egypt and Arabia, were basically a lightly built, gracile or lanky type which is typical of the many of the pastoralists of Abyssinia and Erythraea extending to Northern Kenya and some of the tribes of modern Arabia. The description of the wandering tribes of North Africa from the earliest periods to early Medieval times recalls the phenotypical attributes and customs typical of the peoples of the speakers of the Cushitic and Nilosaharan dialects as well as pastoral Fulani and other Sahelian pastoralists. This is borne out by the skeletal evidence found in the Sahara and Fezzan eras dating from the era of the Garamantes and even before.

Libyan Ethnohistory Before the 5th Century A.D.

In the reign of Ramses II (19th dynasty, 13th century B.C.) the name of Libou or the Libyans first appears. The garments of the Libou chiefs were garments which are decorated similarly to those of the Tamehou whose name appears as early as the 6th dynasty several centuries earlier.⁴⁰ *Tjemehu* or *Tamehou*, as I have stated before, occupied the oases adjacent to Nubia in Sudan and presumably Kharga in the western desert in southern Egypt. At Es Sebua in Nubia an inscription tells of the Temehou who in the 5th year of Merneptah (19th dynasty) led a raid against Egypt under the Temehou Maraye, son of Ded, along with other Libyans called Kehek and the “peoples of the Sea.”⁴¹ It was the Libou who, as a branch of the Temehou, launched invasions against the Egyptian dynasty of Merneptah. They did so in alliance with the descendants of the non-African Sea peoples who were of Euro-Asian origin. These Euro-Asians are also represented in Egyptian iconography of the “westerners.”

The name of one king of the Libou of that time was Meshken. It is, according to Bates, the same as the much later name of the Numidian king called Misagenes by the Romans, a son of a ruler named Massinissa of the



Figure 3. Portrayal of ancient Saharan shepherd. This man with throwing stick, painted face, and uraeus before his brow lived in the ancient Tassili region of Algeria, where the Garamantes once roamed.

3rd century B.C., and in Berber, according to him, would mean "son of heaven."⁴²

The existence of kings among the Numidians and Mauri "is first directly attested to at the end of the 5th century before Christ," about the same time Herodotus wrote of the Libyans.⁴³ By the end of the 3rd century B.C. the kingdoms of the Masaesyli (who are one of the Libyans mentioned by Herodotus) and Massyli "had emerged from among the Mauri" in the western part of North Africa.⁴⁴ Some of the names of the rulers of the Maures as named by Procopius and others seem to reflect their ethnic affinity with the so-called "hamitic" stock of Ethiopia and Sudan, especially modern Cushitic speakers. Gaia, Bagoda, Acallis, Baga are reminiscent of the present names for rulers, chiefs and princes not only among modern Tuareg or Berbers but Nilotic and Cushitic tribes of East Africa. *Gaia* was probably *Kaya* among Berbers and Kushites and the same *Qe* means ruler in Meroe (Nubia). Acallis or Agallid, is Aguellid or Okel of the Berbers and Kel of the East African area. Bagoda is prince or religious head as is Bukharis of ancient Nubia and the modern Cushites, a legendary Hausa king and god of the Nilo-saharan Teda.

In the 4th century A.D. the Mauri Bauers or Bavares are mentioned along with the Quinquegentiani or Mauri Gensani and Frexus (Afer or Ifuraces) as breaking into the Moroccan area of ancient Numidia. The Bavares or Baueres are also called Bavares of the Kabyli (or Kabyles). It was one of the Kabyle chieftains, Gildo (whose name is the Berber title Gallid or Aguellid) whom Claudian complained about when he spoke of all the "hideous Ethiopian hybrids" being conceived with the Roman women. Gildo belonged to a family of rebellious rulers of the Kabylian Bavares who were Mauri Baueres of other texts.⁴⁵ He had a brother named Mascezel, which is Amazegzel, the modern Berber or Tuareg tribal name.

In the east were other descendants of the Lebou. Herodotus describes a Libyan contingent in the Persian army 480 B.C. using wooden spears. After the death of Xerxes, the Persian king of the 5th century B.C., Ianheru (Inaros) chief of the Adyrmakidae (or Adyrmalekhidae) in alliance this time with the Greeks, led a revolt against the Achaemenids of Persia who were in control of Egypt.⁴⁶ The Libyan Adyrmachidae had a nymph named Amphithemis as their ancestress, as did the Psylli, and Machyles, according to the ancient writer Agrostus. That name may be connected with that of the Akkadian water goddess Tiamat.

In the 1st century B.C. Diodorus Siculus stated that in northern Tunisia, a lieutenant of a Greek tyrant from Syracuse called Agathocles overcame a people in the 4th century B.C. whose skin color "was like that of the Ethiopians."⁴⁷ In the time of this invasion "Libyans" called Massyles were in control of the Tunisian area. These indigenous Libyan tribesmen were later called Afri or Afer, Afaricani or Frexus by the Romans and Maures or Maurusioi. The writings of Pliny, Josephus, Cleodemus and later Arab tradi-

tion all say that they both came across Africa with Hercules and by way of the Red Sea or Berber region now called Abyssinia and Erithrea and imply that they were associated with the incense-trading peoples on both sides of the Red Sea. Perhaps the name of the present day Afar in Djibouti and Ethiopia is connected. Certain Tuareg tribes especially in Niger still call their ancestors Argulen.

Although Carthage which was in the area of Tunis was a Phoenician (Punic) colony, mostly Libyans like the Afar composed the Carthaginian army; native Carthaginians formed a very small portion of the troops.⁴⁸ The Egyptian portrayal of Carthaginian soldiers leave no question as to the "Ethiopian-like" appearance of the "Libyans" or North Africans of that area and era. Sometimes Greek and Gaulic mercenaries were used as well.

The Afaricani in particular had learned new military techniques serving as heavy infantry in the Punic army and the best light infantry troops were javelin throwers recruited from the Numidians and Mauri... who were the inhabitants of Northern Algeria and what is now called Morocco. "They adopted municipal institutions of Carthage but frequently revolted against Carthaginian rule."⁴⁹ This had happened once after the Carthaginians abandoned a large force of Libyans in Sicily a few centuries before Christ.

Before the rise of the Carthaginian statesman, Hanno, in the 3rd century B.C., Carthage as the Phoenician colony, had been paying tribute to the surrounding Libyans. After this period, during the time of Hamilcar Barca and his son Hannibal, (who incidentally in ancient texts was called Hannibal the Afer), Carthage was holding sway over the area. Numidians and other Libyans went with the Afar or Afra warriors, led by Hannibal, across the Alps to subjugate the Romans who were becoming a formidable and unbearable presence in Africa. Several centuries later after the 6th century A.D., descendants of these tribes under the name of Beni Ifren or Ifuras (Afer), Mazighzel, Luwata, Goddula (Gaitules) and Kitama or Imakitan (Makidae) swept into Europe in the name of Mohammed.

The present day names of the dark-colored Tuareg tribes of Iforas or Kel Faruwan around Ghat in Libya and Asben in Niger and elsewhere are the same as those of the peoples called Beni Ifren in Algeria by the Arabs and are the Ifuraces or Frexus of Pliny, Aferi of Tunisia and the Pharusii of the Atlas in Morocco of the ancient Greeks and Romans. The Beni Ifren mentioned in Arab writings were found in the area of Tlemcen near Oran in northwest Algeria quite close to Morocco and in the Gharian in western Libya. Representations of chariots from Hoggar to southern Oran through southern Morocco and the western High Atlas may be associated with them.⁵⁰

The Iforas, Iforaces or Frexus in the Tunisian area in Pliny's time are the reason why the name *Afrika* originally denoted the Tunisian area. Historians know that one of the earliest mentions of the camel in North Africa first appears in association with a Berber people called Zenata whom were com-

prised of the Ifuras and other tribes. (see below) The Zenata also early occupied the Cyrene area of the country now called Libya during the Roman era. The word Afra and Afer came to be used for a time for black Africans according to Rogers.

Mauri Mezikes are mentioned as a small nation of "Ethiopians" in the area of Tripoli and Tunis in the 4th century A.D.⁵¹ In the 4th and 5th centuries, the Mezikes who were called a fierce "Libyan" people and who had ravaged the oases next to Egypt and the Fezzan area (Libya) were said by Evagrius to be in allegiance with the Blemmyes of Nubia. The word Blemmyes comes from Belhmt, the Coptic word for the Bedja or Bedouin tribes of the Nubian desert. The Mezikes were the people called Levathes by Procopius and Corripus by the 6th century. They are said to have among them the pitiless pillaging Astacures or Astrikes who were mentioned earlier as being inhabitants of both Ethiopia and Libya.⁵²

It is possible that the Austura and Mezikes were the same as the people called Blemmyes in Ethiopia whose rulers were called Ilam Meshi. In any case it is known that the Luwata tribes are in part the ancestors of the modern Tuarek. The people of the Astures or Astrikes are known under similar names today. From their name probably comes the modern name of the Tuarek who are also called Tura or Targi depending on the region. Some suppose, however, that the name Tuarek is the same as the Arab word meaning tribe. The Tuareg are a confederation of Berber tribes whose men wear veils and turbans. They are camel-owners now dwelling in the Saharan and Sahel areas. The description of the Austures as fierce and much feared pillagers is one that was quite appropriate for the Tuareg to the beginning of this century. Their nobles are still called Imoshagh or Amazighen (Mazikes). In fact Imoshagh is a generic term for Berber nobles. Tamashek the language of the Tuareg means belonging to the Mashek or Mezikes.

In their least modified form they are dark-brown in color, tall and lanky, with elongated limbs, long faces and narrow noses and an extreme long headedness which one noted historian felt was due to having migrated from their "hamitic homeland in East Africa."⁵³ The Tuareg women "marry at will, speak in council, serve as heads of encampments, hold property, govern the home." The children take on the name and rank of their mothers. Tuareg women, rather than men, teach their children to write. They are found in areas extending from Mauretania through Mali and Algeria to Chad and Libya. The Tuareg have many customs and features in common with the Bedja Cushites which may speak for a common region of origination. (see section on Bedja ethnicity below).



Figure 4. Chariot drawings from the Air region of Niger. Chariot representations appear throughout the Sahara. They were commonly used by the Libyo-Berbers including Garamantes, Maures and Pharusii.

The Fulani as Gaitules

Probably the best living example in North Africa of those originally nomadic peoples called Libyans are the modern day "red" or pastoral Fulani (as opposed to the settled Fulani) especially belonging to the area of Niger and Mali. Though they themselves are probably descendants of only one of the waves of Libyans from the east, they represent the black Berber or hamitic" prototype which has existed in the Sahara for at least 5,000 years. At Jabbarren the rock art shows cattle transporting the armature of huts which is a practice maintained by the Fulani and the head gear, clothing, and most typical physical characteristics of the human figures of the pastoral period are said to resemble the present day Fulani.⁵⁴ They have, except for their language, many habits of dress and accoutrements in common with Somali and Rendili and at times a strong familial resemblance to Cushitic peoples in general.

These nomads are one of the few tribes whose attire still resembles the long garments worn by the Libyans on ancient Egyptian tomb paintings after the New Empire. On these garments are the same designs that appear on C-group pottery and in Libyan tatoos.⁵⁵ They also wear the same hats and peculiar Libyan side lock and other coiffures shown in representations of ancient Libyans. They still practice the burning of the temples of infants which Herodotus mentions as being common to all Libyans. They often have a hairstyle in which they leave their hair long in the back like the ancient Libyans called Machlyes. Their women wear their hair in a crest like the Cushitic speakers and the other Berbers of the southern Sahara which was said to be typical of Libyan women. This form of hairdress is shown often in ancient rock art now in the Sahara (It was apparently a very ancient practice and of totemic or religious significance: It is found among dark-skinned Yemeni women as well).

The pastoral Fulani are the only people in West Africa who milk their cattle and though they have recently been touched by modernization, rarely did they raise cattle for food. (The ancient Libyans did not eat the cow, considering them sacred). Like many traditional Cushitic and Nilo-saharan peoples they tend to know each of the members of their herds by name and treat them with great affection and respect.⁵⁶

The Fulanis of Takrur were called Beni Warith or Waritan of the Beni Goddala or Jeddala in the *Annales Regnum Mauretanie* (Annals of the Mauretanian Kings) and the writing of el Bekri.⁵⁷ They were said to have once lived in the Mauretanian Adrar. Goddala is the Arab pronunciation of the earlier Gaituli of the Roman historians. The Gaitules were the most populous of the Libyan tribes of Strabo's time (1st century A.D.) Josephus around the same period claimed that they were the same as the Evalioi of Kush or the peoples of ancient Avalis (Hevila) — the Zeila of present-day Somalia, which might explain why the Fulani today resemble so much the people of that region.⁵⁸

The Goddala were considered one of the major Berber tribes by Arab writers and the brethren of the Anbiya (Anbat) and Sanhaja or Berbers of the Maghrib. Furthermore, when the Fulani were first encountered by European colonists, they spoke more than one language. One of these is connected to other West African languages. The other one, however, was considered different enough for the explorers to speculate that it was more related to dialects outside of Africa.

If the Fulani as suggested by El Bekri and the Mauretanian Annals were Goddala, then it is most likely their ancestors are the same as those of the Cushitic speakers who now inhabit the Horn of Africa and that are also the same as the lightly built, Libyan Gaitules who lived further North during the Roman era and took part in the founding of Numidia.

C-groups as Ancestors of the Eastern Libyans

There is a strong resemblance, according to a number of scholars, between the ancient prehistoric culture of the Southern Sahara and those of the ancient pastoral cultures in Nubia especially represented by the C-group population. One specialist in African archaeology, David Phillipson, has relatively recently stated that the affinities of C-group pottery strongly suggest a Saharan origin.⁵⁹ However Gabriel Camps before this had shown that ancient Saharan industries possessed close affinity with the neolithic industries of the Nilotic area. The rock art of the Tassili region of Algeria and also in Ennedi of Chad and the Tibesti region, a pastoral period between the 4th and 3rd millenniums B.C., depicted cattle with horns deformed and with curious pendants typical of those of the Nubian, especially C-group area and further east. Fine sculptured cattle and other anthropomorphic cult figurines appear at the sites as they do East of the Nile. The men are often represented, according to Camps, as men resembling the Fulani, slim with dark complexions and small pointed beards rather like those portrayed in rock art of the Arabian desert spoken of by Anati. Ancient stone tumulus graves in the western part of the Southern Sahara are reminiscent of those built by C-group.⁶⁰

The territory of the Tamehou or Tjemehu has been suggested to have corresponded to the general area of of the C-group populations who occupied the Libyan desert of Sudan and parts of Nubia.⁶¹ Both A. Arkell and Bates had come to conclude that the C-group Nubians represented a Libyan people. A. Arkell and Bates also felt the people of this culture (C-group) were the Libyans whom the Egyptians called Tjemehu, who are mentioned as early as a 6th dynasty inscription in a land to the south of Egypt.⁶² C-Group pottery has been found in the Gilf Kebir in Libya and the Wadi Howar to the west of Nubia in the Libyan desert.⁶³ C-group people were also affiliated with the kingdom of Kerma in Nubia.

The C-group material "affords several representations of the human fig-



Figure 5. Modern Fulani men also called Peul or Fellata. In Arab writings they are considered Waritan Sanhaja of Goddala (Gaitulian) stock. They wear the turbans and hats commonly worn by the ancient Libyans and Saharans.

ure." Some are wearing crossbands which were "so frequent" in Egyptian portrayals of the Libyans. Bates also found correlations between the designs on C-group pottery and ancient Libyan tattoo-marks (both of which he illustrates in his book, *The Eastern Libyans*). He also notes that one of the female figures represented on the pottery was a woman wearing a kirtle like the Libyan women are shown wearing in the ancient Egyptian portrayals.⁶⁴

In addition, the fact that there was a cow cultus in the C-group complex which was "paralleled" by the Libyans; the similarities in "material culture"; and the fact that the C-group cemeteries were in a district geographically connected with the Egyptian oases are factors which he finds to be evidence of the Libyan connection of these remains. C-Group populations skeletally, according to Bates, bore an indubitable resemblance to those of ancient Egypt, but became increasingly mixed with other African populations. The pottery of the later Meroitic period retained resemblances with that of the C-group.

Other modern specialists have come to associate the spread of C-group with the early radiation of Nilo-Saharan speaking peoples.⁶⁵ The huts of Nilo-Saharan speaking tribes living in modern Ethiopia resemble those pictured on a Meroitic vase at Karanog. The Nilotic peoples create small cattle cult figurines and deform the horns of their cattle as do the Cushites. It is likely that the Nilo-Saharans, like the Teda and Zaghawa groups and Masai, who physically have been described as "half-hamites," and whose pastoral culture shows many resemblances to modern day Cushitic or ancient Troglodytes of the Red Sea nations emerged from a confluence of distinguishable African physical types in the Nubian area, and moved at different times westward and then south and eastward carrying religious and ontological notions, customs and varying degrees of technology of the Kerma and Meroitic kingdoms with them.⁶⁶

Archaeological Evidence for the Nubian Affiliation of the Berbers

Just as other nomadic peoples like Nilo-saharans anciently and more recently the Fulani have extended themselves across the Sudan from Senegal to East Africa, it seems ancient Nubian nomads originating east of the Nile ancestral to modern Beja and Afar, had from an early period spread themselves over the North African area between the Atlantic and Red sea, retaining their names. To them may have been due the horse chariot and later the camel and veil in North Africa.

As Oric Bates, writer of *The Eastern Libyans* pointed out, the stone tumulus graves of Nubia typical of C-group and Pan-Grave culture closely resemble the type found in the Western Sahara called by the Tuareg regem or argem.⁶⁷ The tombs regularly measuring 8 to 10 meters in diameter contained burials in

which the bodies are found in a contracted position. Offering niches were outside the super-structure of the tombs in both the Nubian and Saharan tombs. Henri Lhote, had noted that these graves found in the location of Air, Ain Sefrah, Oranais, Cyrenaica in the Adrar n'Iforas and in the Azgar Tassili in Algeria recall the present-day geographical situation of the Tuareg. These tombs are considered rather late in date, later than the pastoralist phase mentioned previously in date, but pre-Islamic.⁶⁸

These tombs were also studied by Camps and described by him as being made of stones of diverse dimensions, circumscribed at the base by a range of larger stones fixed in the earth. They are the most frequent of burial monuments in North Africa, extending from above the Atlas throughout the Sahara to the Niger and from the Nile to the Canary Isles.⁶⁹ They appear in Rio d'Oro, Fezzan, Cyrenaica and Abyssinia. He calls them a type as ancient as the Memphite period in Egypt. The body was found normally in the customary retracted position.

Camps said this type of tomb with niches or chapels was built by the "Equidian" or chariot using Berbers, whom he describes as warriors armed with javelin and arm-dagger, plumed with ostrich feather, and at times associated with crescent shaped monuments.⁷⁰ In fact such men appearing in the rock drawings near the tombs wearing single feather and tunics are curiously reminiscent of the Cushitic-speaking Beja and Danakil (Afar) who wear a single black feather in their hair and arm daggers or wrist knives. An early French Mission to the Central Sahara found ancient pottery there formed on basket-work matrix which showed close similarity to pottery made on baskets in use among the Somali and Danakil rather than on baskets now used in the Sahara.

Iconographic and epigraphic evidence also suggests some connections of Saharans with pre-Christian Nubia. Ancient inscriptions in the Tuareg writing (called Tifinagh) on rock paintings are found in association with depictions of camels which are commonly used now by both the Tuareg and Teda and anciently with representations of what Camps calls the evolved Libyan warriors who are depicted through a bitriangular schematism. The figures are sometimes associated with horses and other triangle configurations. The triangle is representative of the horn. The horn in Saharan parlance, and probably in early Erythraean or Afro-Asiatic culture, in general, is associated symbolically with and signifies the hearth or fire altar. The Tuareg saddle pommel composed of three conical figurines resembles triple pronged altars on Nubian pottery. At Naga'a the deities hold weapons with cruciform handles exactly like the Tuareg saddle pommel. The trident is a symbol for the God of water and for the Kanuri it signified the hearth.⁷¹

In the Tassili, at Ouan Mellen, in the Sahara there are 3 figures with 2 triangles comprising their chests and there are faces with long pointed ears, resembling certain mouthless faces with long ears, on Karanog pottery in

Nubia. At Ouan Bender a hut made of triangles is associated with a camel. Certain of the Adebuni tombs of the desert show horned or antennaed tombs reminiscent of these same mouthless faces.⁷²

The designs on Nubian pottery at Karanog circa the 4th-3rd century A.D. and elsewhere consist of triangles and horned altars and the trident. Rock drawings of horned altars appear in Nubia at Tafa or on pottery. Sometimes they are decorated altars with a pedestal and horns on X-group (Nobataean) pottery. Those that appeared in Southern Egypt, the horned altars, are ascribed to the Blemmyes by Hans Winkler. These altars were considered to be connected with the Table of the Sun of the Macrobian Ethiopians, mentioned by Homer (8th century B.C.) and Herodotus, who had their houses under ground like the later Ethiopian Trogodytes called Megabari mentioned by Strabo, Diodorus and others several centuries later, who were most likely the same people.⁷³

Bedja Ethnicity and Origins

As mentioned previously the group of people called Astures or Astrikes who were said to be native to both Ethiopia and Libya may be the forebearers of those first to be called Tuarek and Tura and Dirku in Africa. It is most likely that the migration that brought the camel and veil came into North Africa from the area East of the Nile long after the introduction of the horse.⁷⁴ J. A. Rogers said that the Berbers claim descent from the tribes who were called the Matzoi (Madjaju) in Nubia. This correlates well with the statement made by Ibn Khaldun, of the origination of the Tuareg of the Maghreb or veiled Berbers in the riff area of Abyssinia.

Even in the rather famous Sudanese work "*Infaq al-Masuri*," Mohamed Bello claimed that the Tuareg or "Beri-beri are the remnant of the Berbers who lived between Zinj and Habash" which was the Afar area. There is a considerable mass of historical evidence to suggest that the Tuareg were in part a westward extension of the "Ethiopian" Trogodytes known in more remote times as Blemmyes, Bedja and Madjaju or Medid and Afar, and that they were the people who brought a type of tomb common to both Abyssinia and the Nile to the Sahara.

Certain archaeologists have identified the Madjaju and Blemmyes with the cultural complex called Pan-Grave in Nubia which showed close affinities to the C-group complex.⁷⁵ The Madjaju (or Medid in late texts) people who occupied Nubia and the desert mainly East of the Nile were the soldier caste or policemen used by the ancient Egyptians. They are considered ancestral to the ancient Blemmyes or modern Bedja who are Cushitic speaking nomadic pastoralists who lived in skin tents. They were matrilineal, had camels and innumerable cattle and sheep. The word Bedja is the same as Bediyat or Bedawi from which comes the word Bedouin. It was a name of the tribes of

the Eastern desert of Sudan in the time of the Arab writers especially.

Modern Bedja, Afar and other Cushites occupy the same areas near the Red Sea as the peoples anciently called Trogodytes. They were a people mentioned by Agatharcides, Diodorus and Strabo. The country of the Beja was called, according to a Saidi (southern Egyptian Arab) lexicon, mentioned by Quatremere in the second volume of his *Memoires sur l'Egypte, Ta-aurek*. This was most probably the area of Twarek, mentioned in the time of Amenophis as a region which had been invaded by an Egyptian army.

And the countries of the Trogodytes were the same as those called Berber by the Romans. These were people whom according to Agatharcides and others called their mothers, sheep and their fathers, rams. They were circumcized and drank milk mixed with blood. They buried their dead under erected mounds of stones capped with the horns of their cattle. At funerals laughing took place. They often made their homes among rocks and ravines or grottos as do some of the present day Afar tribes. It has been surmised that their name came to be a punning homophone for a cave-dweller or one who dwells under ground or in grottos because the word came to be spelled with an 1 as Troglodyte. (Trog in Greek means hole.)⁷⁶

Trogodytes occupied the coastal regions along both sides of the Red Sea. In their country was the land of Punt now identified as the modern day Mersa Gawasis a port town in the horn of Africa. There was another Punt (called Opone) further south around the time of the Christian era and Mogadeshu was said to have been called the "Pearl of the land of Punt." According to Strabo, a major group of Trogodytes lived on the African side of the Red Sea (for Trogodytes inhabited both sides) were called Erembi. There were, however, several Trogodyte or Bedja peoples, the most important being called Megabari and Bolgoi, or Erembi among whom were a people called Belhmt or Blemmyes (who were perhaps the same as the Bolgoi).

The ancient Trogodyte practices recall those of the present day Cushites and Nilo-Saharan speakers especially and to a certain extent the Libyans as the ancient Libyans who were said to have dwelled in caverns and man-made grottos. Modern day Cushites and Nilo-Saharans speakers like the Nandi, Masai, Karamajong, Iraqw, Bari, of southern Sudan drink milk mixed with blood. Bongo, Moro and Zande erect mounds of stones and Nandi laugh at their funerals. Often these people place cattle horns on the tombs as do some of the Cushites.⁷⁷

Most of the speakers of the Eastern Sudanic branch of the Nilo-saharan speakers (the Noba, the Tama and Daju and Nilotic Masai-Samburu, Shilluk peoples) have traditions of dispersal from the Nile valley in or near Nubia. It is interesting that when the Ik, who now inhabit Uganda, were first written about by Colin Turnbull, linguists could only find a relationship of their dialect to the Middle Kingdom Egyptian dialect.⁷⁸

A. Arkell mentioned also colonies of potters who speak a Nilo-Saharan

dialect and are called Tama living in the North of Sudan traditionally said to be from Bir Natrun a place which is now desert. The designs on their pottery "imitate" those of C-Group pottery.⁷⁹ As stated before the huts of Nilo-Saharan speakers in Ethiopia have been noted to bear resemblance to those on a Meroitic vase.⁸⁰

Among the remaining grotto dwellers further west are the Nilo-Saharan Tibbu/Teda. Pliny, Strabo and others refer to Trogodytes of Tassili in Algeria and in the Anti-Atlas range in Morocco. The Pharusii (Iforas) are the Libyans whom Strabo says lived in caves or grottoes and were in this region. They are mentioned in the south of Morocco by Salluste.

The Ancient Fezzanis as a Nilo-Saharan People

The Romans speaking of one of their slaves who happened to be a Garamantian described him as "black as pitch." The Garamantes had a sub-tribe called the Tedamansii who lived south of the Syrtis. Seth Bernadete also gives Gamphasantes as an alternative name for the Garamantes. They claimed to be descendants of the earth born Garama. The Tedamensii, Gamphasantes and Nasamones all of Libya and Fezzan were considered a related people. The Garamantes who were named after their capital were spread to "Lake Nouba." One of the Ptolemies also described the Garamantes as "somewhat black" and "more likely Ethiopians" rather than of Libyan origin.⁸¹ Such descriptions correlate well with the skeletal remains of the Garamantian area.

They had been called by Tacitus invincible. They were involved in the trade in salt and gold across the Sahara and their trading extended far to the east in Nubia and to the Carthaginian area and far to the North in Tunisia. According to Robert Graves, the Garamantes were established in the Djado Oasis in Niger from an early period as well.⁸² Transsaharan trading contacts of the Carthaginians were carried on through the Garamantes who occupied oases connecting the most direct route between their brethren the Nasamones to the North and Central Africa. (The Nasamones and Garamantes were both said to be descendants of the same eponymic ancestor Garamas.)⁸³

The names of the sub-tribes of the Libyans called Garamantes, who occupied the kingdom of Germa, and whom Ptolemy II suspected to be Ethiopians, recalls the names of the modern Zaghawa peoples called Teda and Garawan or Goran. The Nilo-Saharans speakers called Teda, Garawa'an or Zaghawa called ahel Gara by the Tuareg are found in desolate corners of the Sahara. They have a homogeneous, unique, physical type, similar manners and customs, social attitudes and gestures. They inhabit many of the oases in the southern Sahara, including Uweinat, Kufra, the Kawar and Tibetsi the Northern parts of Chad and Sudan, and are accustomed to raiding and trading over great distances.⁸⁴ They seem to be the remnant of the ancient Ethiopian peoples extending between Fezzan and the Nubian kingdoms, who in the desert were

called Trogodytes, and who as town dwellers founded the town of Germa or Garama, which in the Teda-Kanuri dialects means place of the Gara. It is plausible that the name of the town and kingdom of Kerma was an earlier form of the word.

The Zaghawa or Teda dialects are closely related to that of the modern day Kanuri who are partially Teda in origin. Recently a J. Sharman has pointed to some "interesting correspondences" between ancient Meroitic and Kanuri languages.⁸⁵ These people after the destruction of the kingdom of the Garamantes had founded the kingdom of the Zaghawa next to the Nobataean kingdom of Nubia.

It is known that the ancient Nouba, or Nobatae who are probably ancestral to modern Nilo-Saharan speakers, still called Noba, living in southern Egypt and Northern Sudan (not to be confused with the Nuba of the Kordofan hills) were descendants of ancient people of the Kharga oasis in modern-day Egypt. The Annoubades or Noba were imported into Ethiopia or Nubia from the Kharga Oasis to check the movements of the nomads called Blemmyes (Bedja) in the time of the Byzantine control of Nubia.⁸⁶ According to Silius Italicus they were a race "blackened by the sun."⁸⁷

As mentioned by Robert Graves the Garamantes were considered to be a Kushite Berber people. We know the Garamantes traded in precious stones or carbuncles with the peoples of ancient Ethiopia (Nubia). The type of cist burial found in ancient Garamantian towns of the Fezzan which are the most ancient cairn type found and spread throughout the Northern Sahara are associated with roughly "hollowed stone bowls reminiscent of those of the southeastern Sahara."⁸⁸ Hundreds of foggaras have been found in the area of Wadi El Agial testifying to their skill in hydraulics. Pyramids that are typical of the Meroitic tumulii also were built.⁸⁹

The Roman General Balbus in 19 B.C. conquered the tribe. In the second century A.D. a group among the Levathes (Luwata) which had been a perpetual menace to the Roman Empire in Africa, invaded the Garamantian territory and subdued the indigenes of Germa forming a confederation called Zenata. Zenata included the Garawa or Magherawa, the Luwata called Ifuraces (Afer) and Meknes.

By the 600's A.D. the populations from Germa or Jerma — the Magherawa or Jerawa in Arab histories, were scattered in posts from Libya to Algeria including the Gharian, the Wargla oasis and the foot of the Aures. In the 7th century A.D., the Arabs came into contact with the Garawa in the region of the Aures mountains in Northern Algeria who were a subject tribe of the Levathes.

According to one writer, in the Berber world there were several famous examples of supreme authority being attributed to a holy woman.⁹¹ One of the most famous stories is that of a queen of the Magherawa named Dia or Daya Kahena who organized her people to stop the penetration of the Saracen

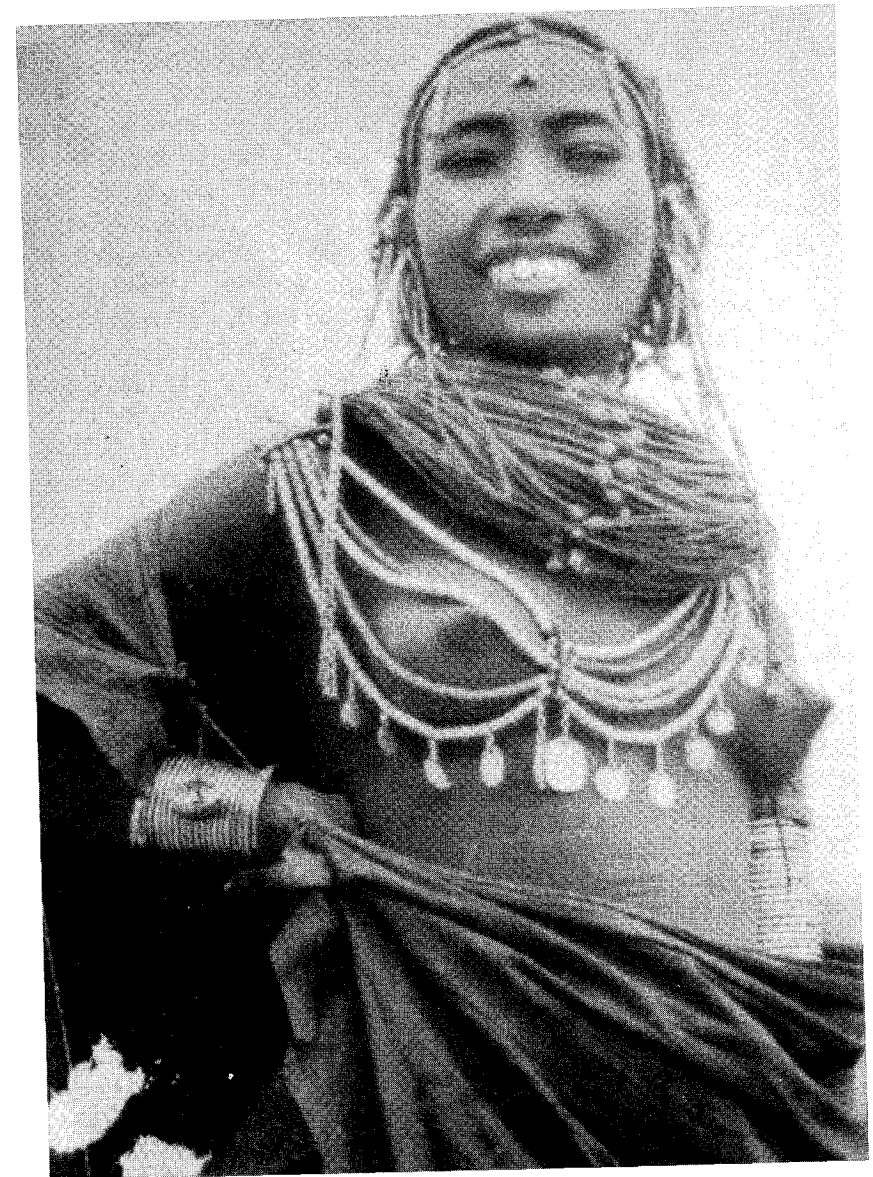

Figure 6. Like the Berbers, the Bedja and other Cushitic and Abyssinian peoples tend to have long, narrow faces and jaws.

Arabs. She was said to be the mother or a close relative of a General Kaiseila of the Luwata in Mauretania (present day Algeria).⁹²

He was able to drive the Mohammedan Arabs North into Tripolitania (in Libya). Later the Saracens succeeded in converting some of the Maures to the laws of Mohammed. The relative of the Dia Kahina was one of the converted, and he participated in the conquest of Spain in the year 711 A.D. with his people. This was after the Dia had been killed in battle with the Arabs.⁹³

These peoples, therefore, were the first of the "Moors" to enter Europe and were peoples closely related to the Garamantes and Levathes or Mauri—the Nilo-saharans and the Tuarek. They ruled as far as the Pyrenees and parts of southern France. About seven years after the capture of Gibraltar or Gebel el Tarik, they invaded France taking Marseilles and Arles in the 800s and capturing Sicily in 837 and seizing Rome in 846. They dominated parts of southern Italy for years.

A famous semi-historical French epic written in 1100's the "Song of Roland" describing this invasion calls them a people "blacker than ink." They remained in France on the western Riviera in the town of Camarque still known as La Petite Afrique or Little Africa.⁹⁴ Early King Arthur stories also describe the Moors as "black as burnt brands." Sir Morien, the Moorish knight is described "as blacker than any son of man a Christian had ever beheld."⁹⁵ The Africans were joined also by some of the Ummayyad Arabs in North Africa and were overtaken only in the 11th century by another Moorish dynasty of Tuarek origin called Al Murabatin or Almoravids.⁹⁶

Remainders of these Zenata, North of the Sahara, still live in Algeria (they are described by one author as a people as "black as Negroes"). They also dwell in the Gharian part of Libya, while other Kel Faruwan or Iforas Tuareg live in Algeria and Niger.

The peoples of Jerma or Garama known as the Jerawa in Arab records of the 6th century had also been migrating, after the invasions of the Vandals and Levathes in Fezzan, into the Sahel and Sudan areas where they later were known as the Ahel Gara, Wangarawa and Garawa'an and even to this day as the Teda are called Gora'an.

The names of the indigenous Nilo-Saharan peoples of the areas directly south of Fezzan today correspond to the names of the ancient tribes of the Fezzan called Tadamansii, Gamphasantes and Garawa. We find tribes in the area of the ancient Zaghawa lands of Bornu and Kanem by the name of Gam of the Kanuri, Gara and Teda. Some of the Zaghawa are called Anu Saman by the Tuarek which Richmond Palmer connects with the name of the Nasamones.

The jet black Zaghawa are still known for their incessant raiding, which was a marked trait of the ancient Libyan culture, including that of the Ethiopian Garamantes. Garamantians grazed their oxen backwards and also rode their oxen just as modern Teda and Kanuri and Nilotes further to the East. The Nilo-Saharan peoples who established the kindgom of Zaghawa

called their kings Kara or Kharkhar (before the Tuareg presence) as was the custom in Nubia. Gora'an Teda occupied the Bayuda desert not far from Meroe as well as the Tibesti area of Chad during the time of Leo Africanus of the 14th century. The desert North of Khartoum was called the desert of Goran in his time. The Zaghawa or Teda peoples have had a strong ethnic and commercial connection with Nubia for thousands of years.

Arab writers attribute the founding dynasties of the earliest known kingdoms of the Sahel and Sudan to Zaghawa. The Tuareg word for Zaghawa people is Izghan and their language is Tazghait. The Kingdom of the Zaghawa still existed and lay next to that of the Nubata (Nubians) in Ya'aqubi's day (9th century). Another dynasty called Zaghwe ruled in Abyssinia near the same epoch. According to the Arab geographer Yaqut Al Mahallebi who lived in the 900s A.D. said that Zaghawa were responsible for Kaukau's existence as a political unit. The Zaghawa of the Sudan mounted horses bareback and their chief wealth was in salt. Yaqu'ubi said that the ruling dynasties of Kaukau were the same as that of Jenne.

Jenne and Kukia (Kaukau) which were ruled by Zaghawa in the time of the Arab writers were said to have existed in the times of the Pharaohs. Kukia was an early terminus of the desert trade and was the ancient home of the Zaghawa called Songhai. Zaghawa were the first rulers of Kanem and Bornu and the Gobirawa of the Hausa kingdoms before the coming of the Tuareg Berber and Arab peoples.

The dialect of the Teda and Kanuri people are connected to that of the Zaghawa of Asben and the Songhai groups. Songhai founded the Gao and Songhai states. Some Songhai regions still preserve the people and place name of the ancient Germa or Djerma in the names Djerma, Zarma and Koroma. Many tribal habitats or place names in the Lake Faquibine area are variants of the name. Some of these Zaghawa in West Africa called Wangarawa, Wakar or Wakore by Arab writers, adopted the dialects of the indigenous peoples of Mali called Mande. These Wangara came to be called the Soninke or Sarakholle and include today Djula and Diallonke and other peoples now speaking dialects called Mande.⁹⁷ Soninke and Sarakholle peoples still consider themselves relatives of the Zarma-Songhai.

Later on other Wangarawa or Wakar merchants related to the Songhai developed the Ghana kingdom in what is now Mali and Burkina Fasso (formerly Upper Volta). They were the early founders of Ghana Empire which was called Wakar or Wagadou. In modern times we find certain Mande-speaking tribes under the name Koromantse on the Upper Niger and the names Gourma-Rarous in Niger and Fada-N'Gourma in Burkina Faso ancient Wagadougou. In the area between Debo and the Faquibene Lakes in Mali were found many diverse names of places more or less approximating the name Djerma. Such names as Dyeram, Dermallah, Ton Dirma in this area of the ancient Zarma-Songhai.

The Nubian affiliation of the ancient Nilo-saharans people explains the adeptness in metallurgy, masonry and sorcery of so many Nilo-saharan and other African groups. From them no doubt were derived many of the legends, myths and cosmology reminiscent of the ancient Egypto-Nubian kingdoms and the traditions of the ruling clans being from the North and Northeast. The metallurgy and masonic skills which led to the pyramids and tumuli in conical and pyramidal shapes spread across the Sudan were no doubt due to the early presence of Zaghawa. Gao was by tradition the home of sorcerers used by the Pharaohs.

To them were due some of the burial customs that once resembled those of ancient Nubia and Egypt and perhaps the megalithic stone circles found in Senegal, Guinea and elsewhere in the Sudan. The spread of this fundamentally Nubian group may have led to the towns named Kerma, Gaourmas, Germa, Djerma found across the Sudan. They would also have brought their astronomical knowledge and highly developed skills in masonry, mathematics and hydraulics into medieval North Africa and Spain.

The Luwata as Tuareg

Tuareg are the direct descendants of the peoples called Maures or Levathes, Mazikes and Pharusii. Their clan names recall also those of the Luwata of the Byzantine period through the time of Arab historians. The names of the Lagwathes or Levathes, known as Maures, like those of the Ifuraces or Pharusii and Mazikes become prominent in literature especially after the Roman colonization in North Africa.

According to D.J. Mattingly the Luwata seem to have been in the process of migrating westward from the area of Egypt in the time of the early Romans. The Levathes or Lagwatin are mentioned in the neighborhood of Leptis Magna in Justinian's time (4th century A.D.)⁹⁸

In Leo Africanus Book VI of the 15th century, the Luwata are mentioned as a people stretching from Aujila to east of the Nile. (Perhaps they are responsible for the present day Lahawi or Lahawiin East of the Nile.) They are the Ilam of Chad epics who by the end of the 12th century had fought the Arab Beni Hilal and lost. After that time the inhabitants of Tripoli, Tunis and Aujila were mostly Arab. By 1269 the Luwata had completely abandoned the Barka (in Libya) area. In the *Infak al Masuri*, Sultan Muhammed Bello wrote of the Bornu and Asben Tuwarek tribes called Kelowi who came from the region of Aujila in Barka (present day Libya). The chief division of the Kelowi is still called Imaslagha corresponding to Ilagwa or the Laguatan of the Romans who were the Luwata of the Arab writers. The Amakitan (Kitama) and Igdalen tribes it is said took Ahir from the Sudanese.

Kelowi belonged to the Uraghen branch of the Tuareg. The Kelowi dialect is still called Aurighaeye. The Uraghen of southern Libya and Algeria be-

tween Ghat and Murzuk in Fezzan are known as Hawara and Ihaggaran. According to Ya'aqubi a 9th century Arab historian, the Hawara abode was in his day from the boundary of the district of Sort to the Tarabolus (Tripoli) and Leptis Magna (Libda). Among the stocks related to them or claiming kinship with them were Luata. They were a very commercial peoples. Another tribe of the Luata that came into the Hoggar land in Algeria he says were called Lamta (Ilam). The Lamta according to Yaaqubi of the 9th century were on north of the road which ran between Kawar in Niger and Aujila in Libya. According to Ya'aqubi they were famous for their shields made from Oryx skin called Lamt. The Tuarek still use these shields.

Cushite Affiliation of the Tuareg

A.D. Maqrissi, a 9th century Arab writer, calls the animal from which the Beja shields were made Aurek (Oryx). Many of the Beja customs of today are in fact the same as the Tuareg. The Tuareg and Beja both have a custom of presenting themselves to a chief and saluting him by putting his hand on the chief's shoulder and doing so several times to show great respect.

The oryx was apparently one of the totemic animals of ancient Nubia. It is seen eating from a table set on an altar (perhaps representing the table of the sun) on Nubian pottery from Karanog. The Oryx bears the totemic designation El Amt which is similar to the name of the female camel the other totemic ancestress of the Cushites — talemt in Tamashek. Silko, king of the Nobatae and the Blemmyae a few centuries after Christ, stated "I am a lion in the South country and an oryx in the North." (The root here *amd* or *mad* is connected with the tamashek word *mad* or *med* which signifies female and earth.) The word for the female lineage or connection is Tamaderechi. At least two ancient kings of Axum were called el Amd or Ella Amida.

The Blemmyes (Bedja) lived on both sides of the Nile in ancient times. They were first known as Madjay or Medid and dwelt in the Eastern desert, but later on Diodorus calls them a Libyan people. Pomponius Mela also said they were a people who dwelt west of the Nile. They are described as black and woolly-haired peoples by Nonnus in his *Dionysica*.⁹⁹ The Blemmyes of Meroe were numerous in the Thebaid 276–282 A.D. operating as far North and East as the Gulf of Aqaba in Southern Palestine. Their nobles or leaders who were the Ilam Meshi, Megabari or Mazikes were considered to have some connection with the rulers of Mauretania (Morocco and Algeria). Certain raiders of the Eastern (Nubian) desert were in fact called Maza to a very late period.

In 380–400 Mazikes ravaged the oases west of Egypt. They also dwelt in Tripolitania. By 545 A.D. the Blemmyes were a considerable power in the deserts of both Upper and Lower Egypt. Heliiodorus said that the Blemmyes anciently had close relations with the Persians during the time of their

conquering and invasion of Egypt and Nubia several centuries B.C., and they followed their method of fighting by shooting arrows from the kneeling position as did the Luata Maures or Mezikes in Procopius time.¹⁰⁰

The Blemmyes were in alliance with the Trogodyte peoples called Megabari who may have been the same as the Mezikes mentioned by Evagrius in contact with the Blemmyes.¹⁰¹ The key to the Tuareg Blemmye connection and the answer to why the Blemmyes are called a Libyan people and the Mezikes called "Ethiopians," may lie in the Bedja connection and that of the Nubian kingdom of the Blemmyes called Makhorrta to the Mezikes. The Blemmyes were a people in contact with Axum, the capital of Abyssinia. The shields of the Bedja were also called the "bucklers of Axum." During the period, approximately the 3rd to the 4th centuries A.D., the Axumite Empire is described in certain documents as the 3rd and 4th world power and in one document Axumite Christians are mentioned as having a victory against Berber indigenes in the Fezzan area of Libya.

The Blemmyes themselves were said to be a people who had been Jacobite Christians since the time the Copts brought Christianity to Nubia. The early Makhorrtae or Makhorra of the kingdom of Makhoria were spread to Algeria, known as Makhorenes around this time. They were converted to Christianity sometime around the 6th century A.D. Today some Tuareg are called Imaghuran and the Hoggar Tuareg were traditionally once a Christian people. Peoples named Magiabara occupy an area near Augila where the Ilam or Luata once roamed and which is the one of the places the fierce Mezikes were known to have ravaged. Late texts speak of people called Mahovera in Nubia.

The name of the Meshi like modern Imoshagh or Mashek of the Tuareg means nobles and is probably related to the name of Mesh or Mash, an ancient Sun god in Nubia usually connected in inscriptions with a God called Med or Mad who was probably the Medir of Abyssinia. Mad is called in an ancient Nubian inscription "he that is great among deserts come from Puani (Punt)." He was chief God at Talmis in Nubia, during the Nobataean and Blemmye period a few centuries after Christ. Mit (Mid, Mad) and Mash are often mentioned as deities in ancient Karanog inscriptions. Med and Mash seem to have been deities associated with fire altars or the hearth as well as the Sun. These deities were derived from the pantheon of the 25th dynasty Libyans according to one scholar.

Fire worship is an ancient Bedja and Tuareg custom. The Tuareg still wear the veil, that was once used to keep them from breathing on the sacred fire. The Titans or Libyan God-ancestors were fire worshippers as Ad of the Koran and Arabic tradition was a "son of the fire mist." Atlas who was Daris or Idris of the Arabs, symbolized in Greek myth by a man holding the four corners of the universe in his hand, was metaphoric of the God called Midilayi or Aman-tar by the Tuareg and Teda who is Lord of the hearth composed of pillars



Figure 7. Women still ride oxen in Chad like the ancient Garamantes of Fezzan.

capped by a rectangular stone which was in some way also representative of the Table of the Sun.

In the writings of Ibn Khaldun, the veiled Lamtuna Berbers, who were and are Tuareg are called Magians worshipping fire. There was a saying among the Tuareg until recently that "fire is an attribute" of a Lord or Noble which is 'Mash.' The word for fire Temsi means belonging to Mash. A chiefdom in Bornu was called "in the fire of" because of the Tuareg descended dynasty there. The manuscripts of that area speak of a sacred fire called Matabar (Mid or Mad). Traces of the Meroeitic Table of the Sun and the fire cult which appears to have once extended past Abyssinia into southern Arabia, Persia and India, are found among the peoples of ancient Bornu. In Kanem (in the Bornu Sudan) a chief used to be installed by lighting a sacred fire under a flat stone superimposed on three hearth stones invoking the God Midilayi Aman-tar. Such ancient stone seats were known to have existed among the ancient Arabian Saracens as far North as Petra (Jordan).¹⁰²

The Bedja were in the time of Maqrisi still adoring the "Pure Fire" which the Arabs called Sheitan (Satan). Sheitan is Arabic and related to the word "Sati" in Amharic Ethiopian and meaning fire. Ibn Selim al Aswani said that most of the people of Alwa in the kingdom of Makhouria, the old center of Blemmye power, sacrifice to the sun, moon and stars and adore the fire and sun as Gods. Every Beja clan "from Alwa to the sea had its priest, who pitches a tent made of feathers in the shape of a dome wherein he practices his adorations." Yaqu'ubi states that the Beja area of Baglin (Bakhoras or Faras) was "an area of many large towns; the inhabitants of which resemble Magians believing in the dual principles of good and evil."¹⁰³ In the 12th century, the Arab author Idrisi mentions the Al Beliu descendants of the Blemmyes as a people wandering in the country of the Beja and Abyssinians, "nomads without settled abode like the Lamtuna of the desert of the Maghrib-el-Aksa." They were composed of sister peoples called Balau and Hafero (Afar).

In fact, the people named Afar who were considered Bedja in the days of the Romans, still inhabit the countries of the horn of Africa (Erythraea, Ethiopia, Djibouti, etc. appears to have some relationship to that of the ancient Iforas, Afer or Pharusii of North Africa. The ahir Tuaregh ancestress Besh, otherwise called T'izki the lame, may be affiliated with the Cushitic Oromo or Galla Goddess named Wesh and the ancient Nilotic God Besh, who was also a lame God and who also appears in very ancient rock engravings in Fezzan.

The Beli of Chad and Sudan or Belin of Ethiopia/Eritrea were a people who were called the Bello of Adal (Adulis) in Abyssinian song. They are probably both Arab and Bedja. The area between Adulis and Suwakin called Kalau Balau was also known as Matat. Today the Beli (also known as Bideyat) in Annadi in Chad, famous for their breed of camels are called Mitmiti by the Kanuri — a name also reserved by them for Tuareg. (This latter name probably

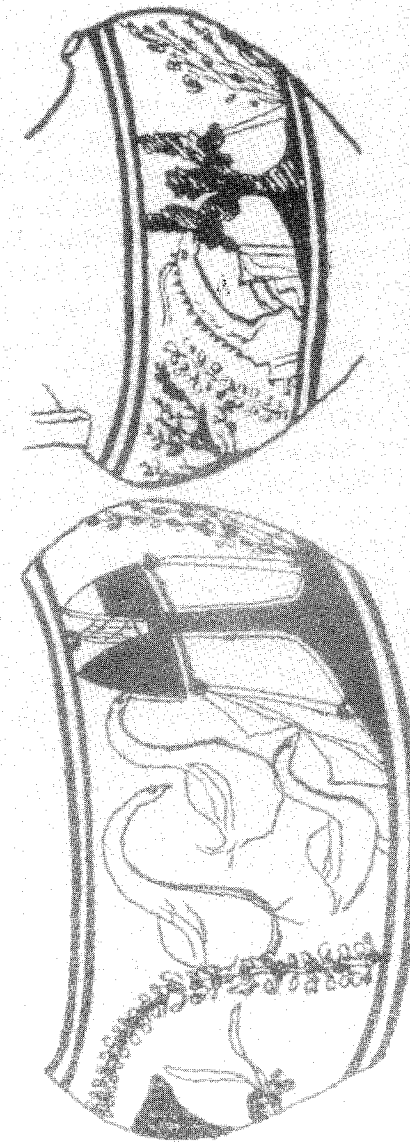

DESIGNS ON BLEMYE POTTERY WHICH PHAROS REPRESENT THE
"TABLE OF THE SUN", 250—545 A.D.
showing the goose of "Amnat" and the oryx (*Ismael*) feeding.

Figure 8. The sacred geese of Ammon and the totemic oryx eat from the Table of the Sun, an ancient altar of the "Ethiopians" of Nubia. Mentioned in Homer's writings several centuries before the era of Christianity.

has affiliation with the name for the early name Madjayu or Matat for Bedja and for the Blemmyes.)

Both the Beli of Ennedi or Annadi in Chad, originally from the Bediyat (Bedja) and the Tuareg have the short arm or wrist swords similar to the Bedja and mentioned by Corripus as being peculiar to the Levathes or Laguatan (Ilam) camelmen of Northern Africa. They call their language Barituki. In Annadi, which is the ancient home of Zaghawa (or Teda) peoples, are traces of mining and working of iron pottery of Nilotic origin. There is also evidence from rock paintings of warriors associated with broad bladed lance "first associated with horses, then later men with camels with pack saddles that enclosed their humps in the Meroitic manner." The Belin of Ethiopia have a tradition that they extend from the House of Tarqe or the Pharaoh Taharqe. The marks worn on this Pharaoh's face in some of his sculptures are still worn by these Eritreans.

Palmer related the name of the Tuareg or Targa to that of the name of the people in Meroitic inscriptions called T'rogu. But this was just a speculation. The latter is probably equivalent to one of the names for rulers or the king ancestor or divine ruler Kar, Ark, Ari or Areg in the "hamitic" and Afro-Semitic dialects. The Tuareg demi-gods are called Argulen, which seemed to Palmer to account for the much recounted tradition of the Hercules who conquered Libya with the Moors and Afarik. The honorific title for Kanuri founders of the (Tuareg) ruling clan called Maghumi was Kurguli. In the tradition of the people called Jukon who traditionally come from Northern Sudan and Nubia, Harkilla was the King of Meroe. Ancient Nubian kings were often named Arkammon or during the Byzantine epoch, Karkar.

The Tuareg, Matat or Madjayu ancestors very probably introduced the veil, and the fire worship or magianism that seems to have been prevalent in the Maghreb until late times into the early Sahara through their contacts with Nubia and/or perhaps during the Byzantine period. The Luata who were the Ilam of the time of the Beni Hilal invasion were said to have worn the veil. An early historical statement that the Blemmyes had no mouths is perhaps explained by the fact that they wore veils. All of this may point to a connection between the peoples called Ilam or Maza (Mazikes) in the Libyan Oases and the Bedja called Megabari and Ilam Meshi of the Blemmyes. These peoples were spread to the Red Sea coast in the East and to Algeria in the West.

The Origins of the Fatimid, Almoravid and Almohad Dynasties

The Berbers by tradition are normally divided into two semi-mythical historical lineages, one called Zenata and the other Sanhaja. The Zenata ancestor Madghis el Botr was identified by Palmer with the names of the areas known as Maris and Pathros which signified the Nubian area south of Egypt

in ancient times. According to Ibn Khaldun the Sanhaja of the Maghreb to whom belonged the veiled Tuareg, Lamta, Lamtuna, Kunta, Gomara and Masmuda of the Medieval period lived in remote times "in the country near the riff of Abyssinia" and "veiled themselves with the litham, a garb which distinguishes them from other peoples." Having multiplied they formed several tribes such as the Godala, the Lamtuna, the Masufa, the Uzla, Targa, Zaghawa and Lamta." According to Khaldun, they lived on the flesh and milk of their camels and never bowed to a foreign yoke.

Eastern branches of the Tuareg fall under the name Imakitan who were called by the Arabs Kitama or Kutama. In the early 10th century Kitama Berbers a people of Sanhaja stock who had occupied the Little Kabyle Mountains of Eastern Algeria, perhaps, since the time of the Romans founded the Fatimid sultanate centered in Egypt under a Shiite leader. They seized Kairouan in Ifriqiyah (which is the old name of Tunisia) in 909 A.D. and established their capital at Cairo in the 970s dissolving the earlier Saracen Abbasid dynasty. The Fatimids are recognized for having reoriented the trade of the Mediterranean. Goods as far away as South East Asia were shipped to the Egyptian region and passed on to Europe.

It is one of their Caliphs that let loose the Beni Hilal Saracens on the Ilam Tuareg who were the Luwata enemies of a then Arabized Egypt. The name Ilam, according to Palmer, is the plural of El or Al which in the Afro-Asiatic dialects (Erythraean) signifies the father or progenitor or God, cognate to Imalhan and Imilli, Tuareg words for nobles. These camel-warriors who figure on the pages of Procopius and Corripus as has been said were described as men "black" in color, who carried a long sword with a short sword attached to the arm like the modern Tuareg in particular. The Zenata were according to one specialist a Luwata people.

The Fatimid dynasty however fell in the 1170's. Control over Egypt passed to slave soldiers of the Fatimids mainly men from Turkey and the Sudan who were actually professional soldiers recruited and trained from childhood. This dynasty called Mamluk ruled Egypt until the era of the rise of the Ottoman Turkish Empire.

In 711 a Berber army led by Tariq put an end to the Visigoth (Germanic) empire in one battle. In the 8th century the site of the town of Tahart in Algeria which traded with the Songhai state of Gao in the same area belonged to the Lamaia (Ilam) and Matmata Tuareg. A few centuries earlier in the 4th century these predatory Maures under the name of Mauri Gensi or Quinquigentiani and Asturikes were nomadised in the Northern part of Algeria extending to Barka in Libya. Other Luata were apparently still present in Northern Libya.

The later "Moorish" dynasties in Spain and North Africa are known to have been founded by the descendants of the Luwata generally called Sanagira or Sanhaja by Arab historians. Many of the famous trading centers and cities of

North Africa were founded by them. In the 9th century, Ya'aqubi says that the Sanagira, a people living near Kairuwan in Tunis were called so because their ancestor had been a native of Singar (Sennar) an area on the Blue Nile. Palmer felt that this was a variant of the name for the Maghreb Berbers called Sanhaja or Zenaga. The Kitama themselves were Sanhaja and according to Ibn Khaldun their brethren were Masmuda and Ghomara. Sanhaja, who made up one-third of the Berbers, after the 10th century occupied mainly the Maghreb al Aksa region extending from Morocco and Algeria and Ifriqiyah Tunis to Niger, Mali and Senegal in the South. Peoples occupying oases in Northern Libya still speak Sanhajan dialects.

These names however reflect the composite nature of the Tuareg confederation of the Middle Ages since the Godala or Gaituli, Afar or Iforas who comprised the Zenata, Zaghawa or Teda were all the names of distinct and separate tribes inhabiting North Africa, and the Sahara since the Roman era and perhaps before. By the time of Ibn Khaldun, other Sanhaja called Lamta lived in the Sahara and in the Sus al Aksa.

The Zaghawa were actually the servile tribes of the Tuareg in charge of caring for the herds or having other agricultural tasks. The Nilo-Saharan castes are known in various regions as Haratin or Ikaradan, Imraden, Inaden or Anbat, they are usually the smith or metal workers who make the knives, swords and jewelry for the noble Tuareg or Imoshagh, and are at times much feared for their sorcery.

The area of which the veil was worn in the 12th century included places as far east as the Red Sea coast. It was worn by the Nubians and by Abyssinian merchants who congregated at Philae.¹⁰³ Today some of the men from the region of Zeila in Somalia still veil their faces. From the area between Tunisia and the kingdom of Tahart, the Berbers generally known as Sanhaja or Zenaga (the Sangira of Yaqu'ubi) radiated over the western Sahara and Maghreb. Certain Fulbe clans are also called Sangirawa, or Shanakora in Hausa. (The majority of the modern day peoples of the Sanhaja to which belonged the Berbers those of the Sus, the Masmuda, the Masufa and the Zenaga or Senhaga S'ghir of Morocco, Lamtuna, Kunta, Nafusawa are dark to very dark. The Ghomara, Kabyles and some of the other Berbers in Morocco are now much fairer, of mixed ancestry, especially those in the Rif area. However, Ghomara and some of these other Berbers still claim to have come from the south.)

By the 900s in the North the Islamicized Zenata dynasties of Maghrawa and Beni Ifuren (Iforaces) and Mknassi ruled the North African cities of Sale, Tadla, Fez, Sijilmasa founded by Mknassi Zenata in 757 A.D. and Aghmat. In the area of the southern Sahara they had a bustling commercial center called Audaghost or Auderas a major town of ancient Ghana, which they shared with the Moorish Arabs. They also ruled Tadmakka a meeting point of caravans en route to Gao from Tripoli in Libya and Tuat. The Zenata

were Ibadite traders and were directly involved in commercial transactions while Sanhaja actually held control of the trade by levying taxes and played the role of caravan guides. The Zenata were said to have become corrupt and parasitical and a new dawn was on the horizon by the end of the 11th century.

During the same century Berber and Moorish kingdoms existed in the Iberian peninsula, although at Seville there were Syrians calling themselves Abbaidids. The Aftassids were Berbers. At Malaga were the Hamdids, (of the Sanhaja) at Granada the Zirids, (also of the Sanhaja) and at Saragosa were Moorish (i.e. "black") Arabs.

The Sanhaja also included the men called Lamta, Lamtuna and Massufa. The Lamtuna today called Aulammiden are the Sanhaja generally recognized by scholars on North Africa to have composed the original Almoravid or El Murabatin Moorish peoples and dynasty. By 1068 the Lamtuna lived to the South of present day Rio d'Oro in the country now called Spanish Sahara. According to Ibn Khaldun of the 14th century the Lamtuna lived in the desert north and north-east of Timbuctu and were "brothers of the Sanhaja."

In the preceding century the Sanhaja called Massufa lived in the desert between Audaghost and Sijilmasa. They controlled the trade routes running through that area. They developed the salt mine of Taghaza. The Sanhaja ruled Audaghost as well which was mostly populated by Zenata and some Arabs.

According to Ibn Battuta, the Massufa tribe were the inhabitants of Tin Bukt or Timbukt and Walata (Aiwalatin) as well. He remarked on what he thought was the great liberty and position accorded women and the custom of descent through women (which is typical of Tuareg clans). He also spoke of their surpassing beauty. Like other clans of the Sanhaja, the Tuareg though Islamized, kept the traditional respect for women once customary to "Ethiopian" peoples in general, which struck the Romans and later Arabs as strange and wicked. (There is mention of Moorish women doctors in early writings about the Moors in Spain.) The Imoshagh don't eat totemic animals representing their female ancestors.

Most of the Arabs that were Moorish and came to occupy Sahara, Libya, Fezzan were descended from the Banu Sulaym, the "hadhara" or black kinsmen of the Beni Hilal. Both had moved from the Central Arabian plateau into the Eastern desert about 1050 A.D. They went west in force waging major battles with the Berbers and leading a major attack on Ifriqiyah in Tunisia ruled then by a Hammadi Sanhaja dynasty. One descended of the famous tribe of the Qays Ailan who were ancestral to several of the later tribes who invaded African countries was said to have said "in the 'hadhara' of the Qays is the surfeit of all my pride." Their descendants included tribes like Aulad Suleiman, Banu Maqil and Banu Hassan. According to the Egyptian writer, Nawal el Sadawi, the prophet said, "I am the son of the El Awatek Atika, daughter of Hilal, Atika, daughter of Mora and Atika, Daughter of El

Awkass from the tribe of *Sulaym*." Both Hilal and Sulaym who came from the central Arabian plateau considered themselves descendants of the Qays Ailan referred to above. [Note: "There are black tribes among the Arabs, such as the Banu Sulaym ibn Mansur, and those not of the Banu Sulaym who stay in Al-harra. They, however, own "slaves" from among the Spanish who serve as guards and water-carriers while their concubines come from Rome" (Kitab fakhr as-Sudan 'Ala al-Bidan by al-Jahiz, 9th century).]

The descendants of Sulaym in south Egypt were and are known as Saidis. Many others like the Beni Maqil went westward to Mauretania and to Senegal where they are called Trarza. They subjugated and converted many of the Berbers, who became Islamic clerics. The latter who became Arabized are found throughout Saharan and Sahel areas and were called Zuwaya. Such tribes as the Mogharba, Chaamba of Chad and Algeria, Kunta of Niger and Mauretania and others played a major part in converting areas of the Sudan to Islam through proselytization, but the Zuwaya especially the originally Libyan Mogharba of Sudan also played a very large part in the slave trade.

The Almoravid movement began among the nomadic Lamtuna Tuareg from the Adrar in Mauretania and later included the Goddala (the Gaetuli). They controlled the caravan routes from southern Morocco to the western Sudan in the middle of the 11th century A.D.; they captured Auderas or Audaghost the chief desert port of the Ghana empire, then the town of Sijilmasa in southern Morocco. One of their leaders Yusuf founded Marrakesh. By the end of the 11th century, they had captured all of Morocco and western Algeria and Muslim Spain (some of the Moorish men of Spain are described as wearing veils.). However, they failed in their attempts to gain hold over the nomadic Fulani in Takrur who were Goddala. The Al Moravid empire lasted only half a century until it was overtaken by other peoples also of Sanhaja stock — the Masmuda who established the Almuwah'hidun or Almohad dynasty. The Almohads destroyed Sijilmasa in the 1100s. At its height they had the best fleet in the western Mediterranean. This period also witnessed the finest of Muslim architecture in Spain and Morocco.

Many of the arts and letters "of polished upperclass life" continued in local centers like Granada long after the Moors lost control of the area. The Moors built in Granada what is considered one of the greatest known works of architecture and art — the castle Alhambra (later a Christian artist painted the human figures that appear on the ceilings which the strict prohibitions of Islam and Arab tradition would not have permitted).

Moors appear in depictions of this period as slender, black, bearded men. There are similar representations of Moors and white Portuguese in Japanese paintings dating from the time of the first Portuguese visits to the Orient. One famous painting shows bearded slender Moors at leisure — one is handling a harp, others play chess and they wear apparel typically worn by today's Fulani nomads and other southern Saharans.

The Moorish civilization was of fundamental value in creating a rebirth of

culture and arts in Europe and throughout the world. Many native dances and stringed instruments that are now European have their roots in the Moorish cultures of Spain and Portugal. To the smiths of the Moors (probably the vassal smith castes of the Tuareg and Arabs) were due the development of major masonic orders in western Europe. They brought with them metaphysical and esoteric traditions and masonic-related sciences (like Algebra) that were many thousands of years old.

From the Moorish stock came many of the great early European philosophers and astronomers including Spinoza, Albu Masur and Ibn Rushd. Moors were the greatest influence in the development of the chivalrous era and they introduced such things as were associated with knighthood, horse breeding and war, including jousting, fencing and the board games that developed into modern day chess and checkers. One can see in Bornu today men wearing light armor, and jousting on horses covered in palls reminiscent of those that the horses of European knights used to wear. The Tuareg tradition of according women great respect was influential in developing a kind of chivalrous attitude of European men toward women which became a virtual code of gentility among knights and the "gentle-born." (Of course, women never achieved real social liberation or the honor that was customary for Berber and other African women long ago.)

Many a family in southern Europe bears the name of the ancient Moorish tribes of North Africa. Such names as Ortega, Medina, Alvarez, Silva and Tzigane and especially names that start or end with *ez* and *es* among Spanish descendants, and names like Mussulini, Caramante in Italy are actually Berber and Arab namesakes.

Conclusion

The word Moor was used for people basically Berber in origin but then came to include during the Islamic period, the early Arabians. Both of these populations belonged to a physical type or types of men commonly referred to by early scholars as "hamitic," "brown" or "brown Mediterranean." Throughout the Middle Ages and previous to the Atlantic slave trade other men of "black" or nearly black pigmentation, particularly Muslim, came to be commonly referred to as Moors. Although there had been an ancient influx of populations biologically affiliated with Europeans in the latitudes between 35 and 20 degrees in Africa and Arabia, the Northern regions of these areas were still predominantly populated by groups genetically and ethnically affiliated with "black" Africans until the Middle Ages. The increase in migration through the slave trade as well as Turkish rule in the Arab world did much to modify the genetic composition of North Africa and the Arabian Peninsula.

The Berber is not a homogeneous type of man today physically or culturally. The word Berber is probably ultimately derived from an indigeneous

African word related to the word for water or water sources. This may account for why the term was used particularly for highly nomadic and pastoral peoples. The present day use of the term differs in that it mainly is employed for those who speak a "Berber" dialect. These dialects are connected to the Tamashek or Tuareg dialects which belong to the Erithraean or Afro-Asiatic group of languages. The ancient Berbers were ethnically related to pastoralists and nomads of Nubia and extending to the Red Sea. They were the first to be called "Maurusioi" or "Moors."

The "wandering" Libyans of Herodotus, and Greek legend and histories, were direct ancestors of the Berbers spoken of by the Romans. They were traditionally believed to have colonized, prior to the Christian era, parts of the Iberian peninsula and the Mediterranean as well as portions of Asia Minor and the Levant. These men were the first to be called Lebou, Tamehou and Tehenou and are portrayed in ancient Egyptian iconography and literature. The connection between the Tamehou and the C-group population of ancient Nubia and Sudan is fairly well established by linguists and archaeologists.

The "red" Fulani of Niger are perhaps the best example of the ancient Libyan or Gaitulian as he looked to the Greek, and of the Berber as he looked to the Roman. They preserve, more than other groups of the Sahara, cultural features, customs and physical traits described by the Greeks and portrayed in Saharan and ancient Egyptian rock art. These Fulani to a large extent also closely represent the C-group populations of the ancient Saharan and Nubian region, and the so-called "Abyssinian" or "hamitic" type that spread into the Horn of Africa previous to 3000 B.C.

The Berbers of the chariots and camel periods seem to represent additional waves of people from the Nilotic area, as indicated by rock drawings and pottery and tomb types of the Sahara (Hoggar, Tassili and elsewhere) and Nubia. Bedja or Cushites and other occupants of Nubia shared customs similar to ancient "Libyans" and were also called Berbers by the Romans until the end of the Byzantine period.

The Nilo-Saharan speakers are a people who had migrated from Nubia after the end of the Kerma period. They may have emerged from the convergence of Cushitic and other African groups in the area. The Garamantes and related Fezzanese Libyans possibly represent one of the ancient populations that were cultural heirs of Nubia and directly ancestral to modern Nilo-Saharan, particularly Songhai and early Wangara populations.

The Tuareg are descended from ancient inhabitants of modern day Libya, Tunisia and Algeria. They are those called Ifuras or Afer and Mezikes or Ilagwatan Maures by the Byzantine writers. Modern Tuarek or Tamashek speakers share many customs in common with the Bedja. Magism which marked both early Tuareg and Bedja is the original reason for male veiling which was also once relatively widespread among the indigenes of Northeast Africa.

The Moorish dynasties of the Islamic period were comprised of the ances-

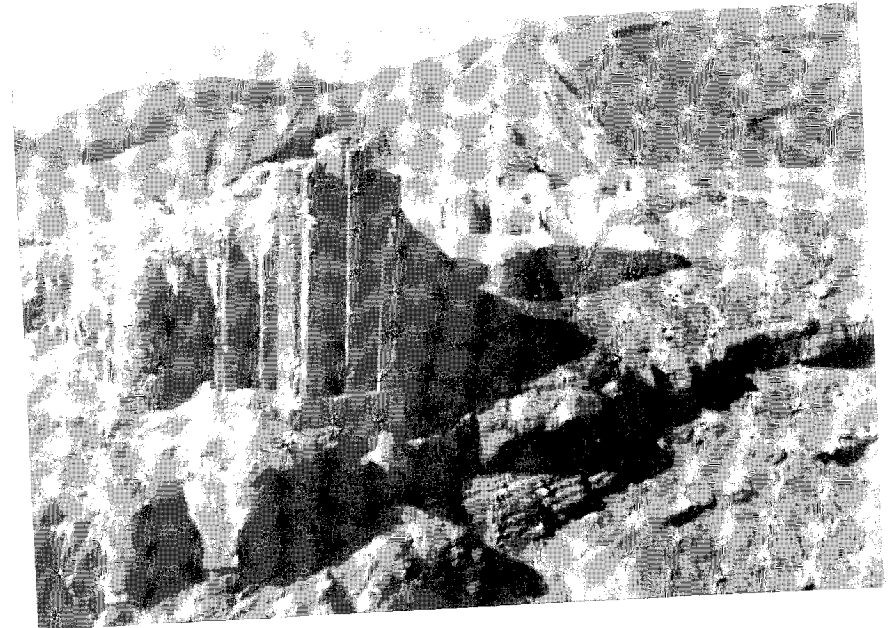

Figure 9. Hammadi dynasty castle. (Period of construction coincides with Almoravide dynasty in Spain). The Hammadi were an Islamicized Sanhaja dynasty that ruled in Northern Algeria from 1055 until 1146. A Sanhaja dynasty called Zirid ruled in Tunisia from 973-984 succeeding the rule of the Fatimids.

tors of modern Teda, Tuarek and Fulani as well as the early Arabians of the Hejaz region of Arabia whose remnants still dwell North of Mecca and in the Yemen. The bedouin Arabs of the Northern and Central Arabian deserts during the period of Roman colonization of the Levant and Arabia were considered by the Romans themselves to be descendants of men who lived in a remote period in the Eastern desert of what is now called Sudan near the ancient Bedja populations (Blemmyes).

The late Moorish dynasties were composed of the ancestors of the men called Tuarek or Sanhaja today, as well as the Fulani. They along with the Moorish Arabs were the main controllers of the trade routes running between the Mediterranean and the Sudan during the Middle Ages of Europe as well as in ancient times.

Moorish civilization was of fundamental value in creating a rebirth of culture in Europe and throughout the world. The ancestors of the Moors were the blacks that had played a part in the ancient civilizations of Arabia, Nubia, the Sahara and the horn of Africa. In those places, they had traded their wares, fought their battles, participated in desert skirmishes and endured the intense heat, scorpions, snakes and sandstorms of the desert, but like their more ancient kinsmen of the great and complex agriculturally-based civilizations, they had also mastered skills in navigation, metallurgy, hydraulics, astronomy and masonry and developed their own particular philosophy of the natural world which pervades our modern major Western religions.

It is a heritage and an era in history that has been neglected for centuries and distorted into something which those who were there to witness it—the Greeks, the Romans and others—would hardly recognize. Hopefully, as more objective research is done on the traditions and history of the Sahel and Saharan areas, of North Africa in general, more illuminating evidence will emerge.

Notes for Introduction

1. Arnold, T., *Legacy of Islam*, 1931, p. 101.
2. Rogers, J.A., *Nature Knows No Color Line*, Helga M. Rogers, 1952, p. 70 fn. citing *Histoire de Barbarie*, Dan, P., 1649, pp. 316–321 and 452–498. Deslandres, P., *L'Ordre des Franc Trinitaires*, Vol. 1 1903.
3. Ibid. Rogers, p. 59 fn. Sir Walter Scott's, "Notes on Thomas Rhymer."
4. Ibid. p. 70 fn., Rogers.
5. Smith G. Elliot. *Human History*, 1919, p. 124.
6. Op. Cit., Rogers, p. 50.
7. Flavius Corippus, *Johannid* Book 1, 245.
8. Procopius, *De Bello Vandalico*, Book IV.
9. Rogers, op. cit., p. 56.
10. Ibid. p. 109.
11. Ibid. p. 73 fn.

12. Ibid, p. 83–86.
13. John G. Jackson, *Man, God & Civilization*, Citadel Press, 1972, p. 276.
14. Rogers, op cit., p. 110.

Notes for Paper

1. Korbishchanov, Yuri., *Axum*, Pennsylvania State University Press, 1979, p. 46.
2. *Kitab Fakhr As-Sudan Ala Al Bidan*, by Abu Uthman Amr Ibn Bahr Al Jahiz, translation Vincent J. Cornell. France Preston, pp. 48–49.
3. Palmer, Sir Richmond, *The Bornu Sahara and Sudan*, Negro Universities Press, A division of Greenwood Press Inc., New York, 1970, p. 216.
4. See the writings of Ammianus Marcellinus Book IV. The Compact Edition of the Oxford English Dictionary says that the Saracens were the Arab Bedouin extending from Mecca to the Euphrates.
5. Greenberg, J. H., *The Languages of Africa*, The Hague, 1963.
6. Ibid.
7. "Abbay,— Documents Pour Servir a l'Historie de la Civilization Ethiopien" 9–10 1978–1979. See G. Hudsons article.
8. Curtin, P. Fierman, S. Thompson, L. *African History*, Little Brown and Company, 1978 p. 121.
9. Anati, Emmanuel. *Rock Art of Central Arabia*. Philby Rykmans-Lippens Expedition in Arabia 1968. Vol I, pp. 8, 9, 153, 181–183.
10. Ibid.
11. Ibid.
12. Thomas, Bertram, "Journal of the Royal Anthropological Institute" Jan.–June, 1929, p. 100.
13. Henri Lhote felt these peoples pushed into Northeast Africa and the Sahara from Arabia around 6,000 B.C.
14. Smith, G. Elliot. *The Ancient Egyptians and the Origin of Civilization*, Harper Brothers 1923.
15. Burton, Richard F. *Personal Narrative of a Pilgrimage to Al Madinah and Mecca*, edited by Isabel Burton, Vol. II.
16. Hiernaux, J. *Peoples of Africa*, London 1974., pp. 126, 149 and 59–68.
17. Op. cit., Palmer p. 272 fn. citing the "Appendix to the List of Provinces of Diocletian."
18. Camps, G. *Berbers—Aux Marges de l'Historie* Toulouse Hesperides 1980, p. 87.
19. See Claudian's *De Bello Gildonico* Book I 189.
20. Camps, op. cit. p. 87.
21. They are seven in number and the modern form of the ancient Kabiri or Ghebers of Afro-Semitic tradition and the Corybantes or heroes of Greek tradition.
22. Huntingford, G. *The Periplus of the Erythraean Sea*, London 1980.
23. Bates, Oric. *The Eastern Libyans*, Frank Cass Publishers, 1970, pp. 13–15, 2nd Edition.
24. *Hamito-Semitic*, J. and T. Bynon (editors) See Vycichyl in Final discussion of "The Archaeological Context of the Hamitic Languages in Northern Africa," 1975, p. 513. See Bates op. cit. pp. 40 and 43.
25. Clark, J.D. *Cambridge History of Africa*, Vol. I, 1982, p. 707.
26. Herodotus Book IV 186.
27. De Sanges, J. "The Proto-Berbers," *U.N.E.S.C.O. History of Africa*, Vol. II,

- editor Gamal Makhtar, Berkeley University of California Press, 1981.
28. Bates, Oric, *The Eastern Libyans* op cit. (1st edition) MacMillan and Co., 1914, p. 66.
 29. Ibid. p. 64. Also, Brogan, Olwen, "Inscriptions in the Libyan Alphabet from Tripolitania and Some Notes on the Tribes of the Region," Bynon, J. and T., *Hamito-Semitic*, 1975, pp. 282-285.
 30. Palmer op. cit. citing S. Gsell, *La Tripolitaine*, and Bates, op. cit., p. 66.
 31. *Strabo*, translation H.L. Jones, The Loeb Classical Library, Harvard University Press, 1967, Vol. 8 p. 167.
 32. Palmer, op. cit., p. 169.
 33. *Diodorus of Sicily*, translation C.H. Oldfather, Cambridge and London: W. Heinemann and Harvard Univ. Press, 1961. II pp. 249-251.
 34. Rothery, G.C., *The Amazons in Antiquity and Modern Times*, (London, F. Gririths, 1910) pp. 118-119.
 35. Temple, Robert, *The Sirius Mystery*, St. Martins Press, New York, 1976, p. 159.
 36. Charles-Picard, G., *Les Religions de l'Afrique Antique* (Paris: Plon), 1954, p. 14.
 37. Arabia in those days included the area east of the Nile in North Africa extending to the Red Sea.
 38. See Procopius' *De Bello Vandalico*, H.B. Dewing, translator, Harvard Univ. Press p. 323 iv, xiii and see summary Reft of the Moors.
 39. Bates, op. cit., first ed., p. 76.
 40. Ibid. p. 138.
 41. *Cambridge History of Africa* Vol. 1, p. 270.
 42. Bates, op. cit., p. 80.
 43. Op. Cit., Vol. 2 Law, R.C.C. "North Africa in the Hellenistic and Roman Periods, 323 B.C. to A.D. 305," p. 177 in *Cambridge History of Africa - II*, Cambridge, 1978, J.D. Fage (ed), 1978.
 44. Ibid. p. 147.
 45. Fried, W.H.C. "The Christian Period in Mediterranean Africa, A.D. 200-700," p. 458. *U.N.E.S.C.O. History of Africa*. Vol. II, Gamal Mokhtar, Editor, Berkeley University of California Press, 1981.
 46. *Cambridge History of Africa*, op. cit., pp. 101-102, Vol. II.
 47. *U.N.E.S.C.O. History of Africa* Vol. II, Gamal Mokhtar editor. See J. De Sanges, "The Proto-Berbers," Berkeley University of California Press, 1981.
 48. *Cambridge History*, op. cit. Vol. II p. 130.
 49. Ibid. p. 184, Cambridge op. cit. Vol. II p. 130.
 50. Fage, J.D. *A History of West Africa*, pp. 14-16.
 51. Gsell, S. *La Tripolitaine* p. 17, cited in Palmer p. 280.
 52. Brogan, Olwen, "Inscriptions..." op. cit. pp. 282-285.
 53. Coon, Carleton *The Races of Europe*, 1979, p. 257.
 54. Hayes, T.R. "Neolithic Settlement of the Sahara as it Relates to the Nile Valley" in *Problems in Prehistoric North Africa and the Levant*, Wendorf, F. and Marks, A. 1975.
 55. Bates, op. cit. p. 251.
 56. Hiernaux, J. *The Peoples of Africa*, London, 1974.
 57. Palmer quoting el Bekri and the "Annales Regnum Mauretanae" (Annals of Mauretanian Kings), p. 61. Levtzion, Nehemia. "The Sahara and Sudan from the Arabic Conquest of the Nagherb to the rise of the Almoravids" in *Cambridge History*, Vol. II p. 637.
 58. *Josephus Antiquities*, Vol. IV, H.S.T.J. Thackery translator, Loeb Classical

- Library, 1967 pp. 65-66 and see Bates, *The Eastern Libyans*, first edition, op cit. pp. 173 and 174.
59. Clark, J. Desmond, "The Spread of Food Production in Sub-Saharan Africa," pp. 31-32 in Fage, J.D. and Oliver, R.A. *Papers in Africa Prehistory*, Cambridge University Press, 19 Phillipson, D. *The Later Prehistory of Eastern and Southern Africa*, London 1977, p. 66.
 60. Ibid. Clark, "The Spread of Food Production."
 61. Op. cit. *Cambridge History* Vol. I pp. 289-290, Bates op cited p. 51.
 62. Arkell, A. *A History of Sudan to A.D. 1821*, University of London, pp. 49-52. Bates, op cit. p. 211, 251, 2nd edition.
 63. Kemp, B. "Old Kingdom, Middle Kingdom and Second Intermediate Period in Egypt in *Cambridge History of Africa*, Vol. I op. cit. 658-761.
 64. Ibid. Bates p. 251, 2nd edition.
 65. McGaffey, Wyatt. "Concepts of Race in Northeast Africa" in *Papers in African Prehistory*, op. cit. pp. 112-113.
 66. Op. cit., "Abbey," pp. 27 and 28,
 67. Bates, first edition, pp. 245-252. op. cit.
 68. Palmer, p. 76, citing from *People of the Veil*, pp. 260-261.
 69. Camps, G. *Aux Origines de la Berberie*, Arts et Metier, 1961, p. 66.
 70. Op. cit., Camps in *Cambridge History of Africa*, Vol. I pp. 619-622.
 71. Griffith, F. *Meroitic Inscriptions*, Volume I, plate XXI, cited by Palmer p. 174 fn. in *Bornu Sahara* op. cit.
 72. Camps op. cit. *Berberes - Aux Marges de L'Histoire*, La Joux Rock Paintings of Tassili, pp. 190-191. Palmer, p. 95, 136-7.
 73. Dunbar, J.H. *The Rock Pictures of Lower Nubia*, Cairo, 1941, pp. 70-75.
 74. Op. cit., Camps, G., *Berbers Aux Marges*, op. cit. pp. 63-68.
 75. Hagg, Tomas, *Nubian Culture Past and Present*, Papers Presented at the 6th International Conference for Nubian Studies in Uppsala, 11-16, August 1986, pp. 113-119.
 76. Huntingford, op. cit. p. 83.
 77. Ibid, pp. 144-147.
 78. Calhoun, J.B. "Plight of the Ik and Kaiadilt is Seen as a Chilling Possible End of Man," in Hunter, D. and Whitten, P. *Anthropology Contemporary Perspectives* 4th edition 1985.
 79. Op. cit., Arkell, A. p. 51.
 80. Op. cot., "Abbey" p. 27 and 28.
 81. DeSanges, J. op. cit. p. 428. See Diodorus Siculus writings Book XX.
 82. Graves, R. *The Greek Myths*, 3.3, Penguin books 1969-1971.
 83. Bates, op. cit. p. 257 2nd edition.
 84. Wright, J. *Libya, Chad and the Central Sahara*, Barnes and Noble 1989, pp. 18-23.
 85. Sharman, J.C., "Meroitic: Its Ancestors and Descendants, Some Relationships" *Azania* 9, 1974, pp. 207-218.
 86. Procopius *De Bello Vandalico*.
 87. DeSanges, op. cit. p. 430.
 88. Daniels, Charles. *The Garamantes of Southern Libya*, Stoughton Oleander Press, 1970, pp. 32-35.
 89. Temple, R. *The Sirius Mystery*, St. Martin's Press, New York, 1976, p. 157.
 90. Op. cit. *Cambridge History of Africa*, Vol. II, p. 509, Palmer p. 17.
 91. Julien, Charles Andre. *History of North Africa*, Translation by Jon Petrie, Praeger Publishers, 1970 pp. 12-17.
 92. Ibid.
 93. Ibid.

94. Rogers, op. cit. p. 69.
 95. Ibid. p. 56.
 96. Meaning men of the holy retreat or fortified place.
 97. *African History* op cit. pp. 93-94.
 98. Mattingly, D.J. "The Laguatan: A Libyan Tribal Confederation in the Late Roman Empire," *Libyan Studies*, Vol. 14, editor J.A. Riley 1983.
 99. See Nonnus, *Dionysiaca*, Book 17, W.H.D. Rouse Vol. II, Harvard University Press.
 100. Palmer, op. cit. p. 114.
 101. Palmer, op. cit. p. 179.
 102. Ibid. pp. 138, 199, 203, 122, 123.
 103. Ibid. p. 145.

THE MOOR: LIGHT OF EUROPE'S DARK AGE

Wayne B. Chandler

The great empires of ancient Africa, both Kushite and Egyptian, collapsed within a few centuries of each other. After thousands of years of achievement in art, science and philosophy, both civilizations died out within a few centuries of the birth of Christ. In addition to internal stresses and conflicts, foreign invaders contributed to the destruction of African civilization. After centuries of encouraging foreign enterprise, Egypt found herself overrun by waves of invaders—Persians, Macedonians, and Romans. In consequence, the African civilization which had for so long inspired the world was plunged into historical oblivion.

In the centuries following the demise of Egypt and Kush, a new culture began to develop. This new culture would generate a resurgence of activity in the arts and sciences, as well as the fiery passion of a new religion. It would consume all of north Africa and would influence embryonic nations such as Spain and France, as well as civilizations already endowed with a cultural magic of their own, such as China, India, and Mesopotamia. The religion was that of Islam, and those that carried it to the corners of the East were the Moors.

The history of the black Moors and their contribution to Moorish culture has been long neglected by traditional historians. The racial makeup of the Moors in Spain, as well as the degree of cultural development of the Moors in Africa, has been disputed. In this respect the black Moors have been subject to the same treatment as have other African or African-influenced cultures—the Olmec, the Egyptian, the Harappan of the Indus Valley—and for the same reasons. It is my intent here to demonstrate that the Moorish culture was largely black in origin, bright in its achievement, and powerful in its influence on western civilization.

Although the term Moor has been put to diverse use, its roots are still traceable. Circa 46 B.C., the Roman army entered West Africa where they encountered black Africans which they called "Maures" from the Greek adjective *mauros*, meaning dark or black.¹ The country of the *maures*, Mauretania (not to be confused with the Islamic Republic of Mauritania in present day West Africa, although obviously the root is the same), existed in what is now northern Morocco and western Algeria. The Greeks themselves, approaching from the east in search of Egypt, called the black Africans they found there Ethiopians from the Greek words *aithein* to burn and *ops* meaning face.² Ancient Ethiopia, also known as Kush or Cush, formed an empire in much the same location as the present day country of the same name.



Figure 1. A Moabit Themim warrior (wearer of the veil) characteristic of one of the several desert factions which constituted the Almoravid dynasty, the third great Moorish empire in Spain.

Both the Roman *Maure* and the Greek *Ethiophe* indicated more than one ethnic group. Herodotus, for example, held that Ethiopians occupied all of Africa south and west of Libya. Europeans used the words *Moor* and *Ethiopian* almost interchangeably to indicate a black African. Several notable black Africans in Roman or medieval Europe had "Maur" as a component of their name. As Hans Debrunner notes, "the outward suggestion that Mauritius might be a black African comes from his [European inscribed] name Mauritius 'the Moor' and from his legendary home, the Thebaid in Egypt."³ Another example of the same occurs in the case of Johannes Morus, born circa 1100, vizier of Sicily. Shakespeare identifies several characters as Moors, apparently meaning simply "black African"; among them are Othello and Aaron of *Titus Andronicus*.⁴

The broad use or misuse of the term *Moor* begs the question: Who were the real Moors? Or, as Chancellor Williams queried with a recognizable tinge of frustration, "Now, again, just who were the Moors?" He continues, "the original Moors, like the original Egyptians, were black Africans. As amalgamation became more and more widespread, only the Berbers, Arabs and coloureds in the Moroccan territories were called Moors."⁵

At the heart of the history of the ancient Moors of the Sahara is a tribe known as the *Garamantes*. According to E. W. Bovill, "ethnologically the *Garamantes* are not easy to place, but we may presume them to have been negroid."⁶ Their homeland was in the area later known as the *Fezzan* in the Sahara; their capital city, called *Garama* or *Jerma*, lay amidst a tangle of trading routes connecting the ancient cities of *Ghat*, *Ghadames*, *Sabaratha*, *Cyrene*, *Oea*, *Carthage* and *Alexandria*.⁷ Far from being the obscure nomadic community stereotyped in European literature, the *Garamantes* were one of the most redoubtable and intimidating forces of the Sahara.

The origins of *Garamante* culture are not easily traced. Rock engravings and paintings done by early Saharans, who in all probability became the *Garamantes*, are difficult to date, but some believe the oldest were executed before 5000 B.C. These rock paintings show domesticated cattle, men riding in horse-drawn chariots, and javelin-armed men riding horses and camels. There are over 300 representations of men in horse-drawn chariots alone, a fact which supports Herodotus' description of the fabulous *Garamantes*.⁸

According to E. W. Bovill, "some paintings give clear evidence of Egyptian influence."⁹ They include weapons and dress drawn in great detail as well as images of strange dieties. The *Garamantes*, or their predecessors, occupied much of northern Africa and were contemporary with the ancient Egyptian civilizations. From this vantage point, they can be considered the ancestors of the true Moors.

The earliest mention of the *Garamantes* themselves comes from Herodotus, who described them in the 5th century B.C. as being absorbed in a rather sedentary lifestyle. However their endeavors in agriculture and com-



Figure 2. Mauritius the Moor. Better known in Europe as St. Maurice. This painting stands 7½ ft. high x 5¼ ft. wide and demonstrates the impact the Moors had on medieval Europe (dated 17th century).



Figure 3. Johannes Morus. Another Moor of saintly status in Europe. This icon is dated 19th century and is to be found in a museum in Germany. He was vizier of Sicily (circa 1100 AD).

merce had already made them "very powerful."¹⁰ In the second century B.C. Lucien noted their habits to be far from sedentary, they were "nomads and dwellers in tents who made seasonal migrations into the remote south . . . They comprised tribes which dwell in towns and villages, and others which were pastoral and nomadic."¹¹ Perhaps in order to protect their trade, they developed military prowess to complement their economic power. By the first century A.D., Tacitus called them "invincible"¹², and Rome was in time to learn how powerful they really were. Unable to subdue the Garamantes, they actually joined them for several trading and exploratory expedition.¹³ Again, according to Tacitus, the territory they controlled by that time constituted the lion's share of north central Africa; "their home country . . . in the heart of the Sahara . . . but their territory and inhabitants occupied the perimeter of the Syrtic Coast and to the southeast it is said their range extended to the Nile."¹⁴

Contemporary with the Garamantes was another group called the Libyans. The Libyans, however, were originally caucasian troglodytes who occupied territory in the far north central portion of Africa.¹⁵ Their presence has been documented since the first dynasty in Egypt, circa 3100 B.C. Dr. Rosalie David, an Egyptologist, describes them as "people with distinctive red or blond hair and blue eyes who lived on the edge of the western desert"¹⁶ bordering Egypt. According to Gerald Massey, the Egyptians called the Libyans Tamahu. "In Egyptian, *Tama* means people and created. *Hu* is white, light ivory. *Tamahu* are the created white people."¹⁷ The Libyans role in that illuminated epoch of African history was to provide a constant irritant to lower Egypt. Several border skirmishes took place, culminating in extensive raiding during the 6th Dynasty. As DuBois notes, "there came great raids upon the Libyans to the west of Egypt. Tens of thousands of soldiers, negros particularly from the Sudan, beat this part of the land into subjection."¹⁸ Sethos, a Pharaoh in the 18th Dynasty, again confronted the Libyan foe and subdued them.

The amalgamation of the Libyans with other races may be attributed to several different factors. Surrounded by darker people on all sides but the Mediterranean Sea, the fair-skinned Libyans constituted a small minority within the black African continent. In addition, nomads of the Arabian Plate fled their barren and drought-stricken homeland in search of more fertile lands to occupy. The blending of black Arab and Libyan produced a light-brown or olive-skinned people who came to be known as "tawny Moors" or "white Moors," often known in history as the "Berbers." The word Berber had its base in a Roman expression "barbari." When the Romans encountered the Libyans they referred to them as barbarians and the coastal region they occupied later came to be known as the "Barbary Coast." The Arabs later adopted the term and changed it to Berber. Eventually, the words Libyan and Berber became synonymous.

Another factor in the racial blending of blacks and Libyans was the Roman

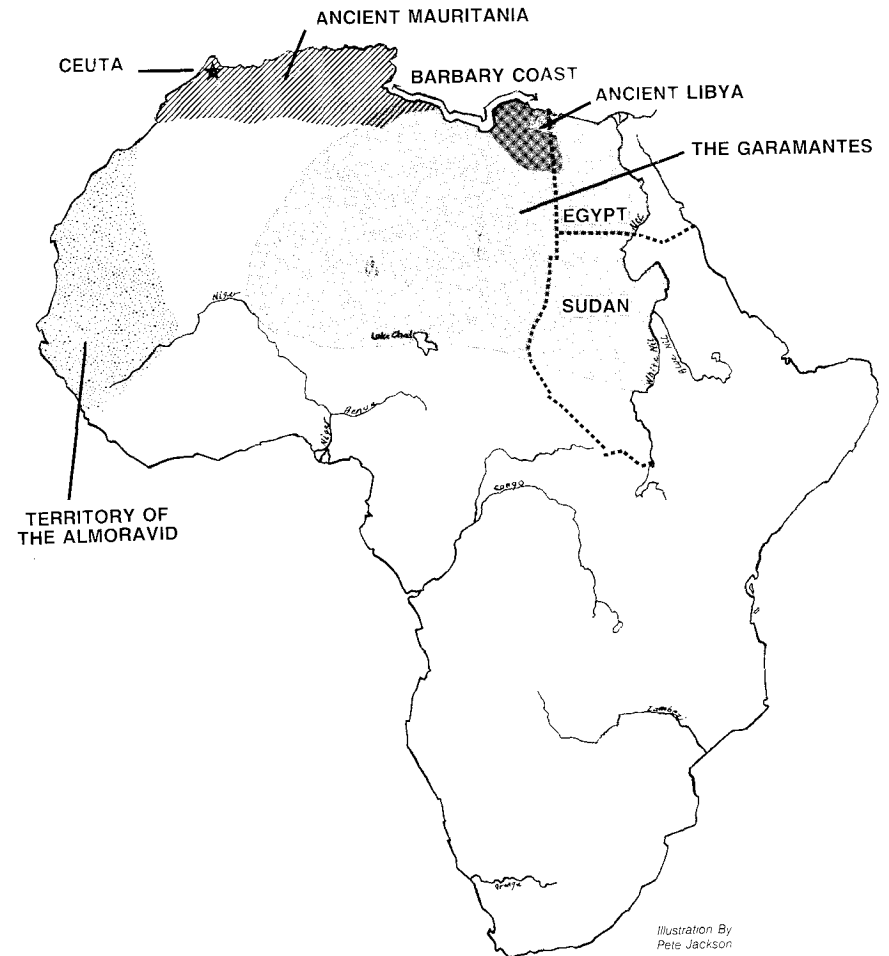

Figure 4. Map of North Africa during Moorish occupation of Iberia (illustration by Pete Jackson).

intervention along the northern coast which forced thousands of these Berbers into the desert seeking protection and aid from its indigenous black inhabitants. The alliance of these racially different groups laid the foundation for the racial diversity which in later centuries would characterize the Sahara. As E. W. Bovill notes, "The Romans . . . antagonized the tribes of the northern Sahara and the desert became both a refuge and a recruiting ground for all who rebelled against Rome."¹⁹ The best documented example of this is that of Tacfarinas, a Roman-trained Libyan soldier, who appealed to the Garamantes for aid in 17 A.D. According to Bovill, "for several years Tacfarinas successfully defied the alien overlords during which time he was twice compelled to seek refuge in the desert. On the second occasion, if not the first, it was the Garamantes who gave him shelter."²⁰ Bovill also speaks of a Berber tribe known as the Zenta who, under Roman military pressure, migrated into deeper areas of the Sahara.²¹

So in time the Sahara came to be occupied by two distinct groups of people: the original Maurs or Moors and the Berbers who later became Tawny Moors. The rest of North Africa, from Egypt through the Fezzan and the west of the Sahara to "Mauretania" (Morocco and Algeria) were peopled by black Africans, also called Moors by the Romans and later by the Europeans.

Eventually, these Moors would join with Arabs and become a united and powerful force. A period of cultural dormancy, characterized by the treachery and violence of tribal rivalry, concluded in the 6th century A.D. when a commanding and mystic figure arose from Arabia. Known as the prophet Mohamet, he brought religious and cultural cohesiveness to the sword-wielding nomads of the Sahara, as he had done in his native land. "The prophet Mohamet turned the Arab tribes, . . . into the Moslem people, filled them with the fervour of Martyrs, and added to the greed of plunder the nobler ambition of bringing all mankind to the knowledge of the truth."²² Two central figures, both of whom were black African, did much to aid Mohamet in the dissemination of Islam. Bilal-i-Habesh (Bilal of Ethiopia) and Zayd bin Harith both shared a special place in the prophet's heart. Bilal was the prophet's closest friend, who in the hereafter was chosen by the prophet to protect him. It was the voice of Bilal that was used to call the Arabs to prayer. Zayd was a great Moorish general who aided greatly in territorial conquest. But before continuing the story of Mohamet and the Moors, Mohamet's native country and people must be considered.

Arabia itself had first been populated by black people. As Drusilla Houston states in her classic text, *Wonderful Ethiopians of the Ancient Cushite Empire*, "the Cushites were the original Arabians . . .,"²³ for Arabia was the oldest Ethiopian colony. According to Houston, "Ancient literature assigns their first settlement to the extreme southwestern point of the peninsula. From thence they spread northward and eastward over Yemen, Hadramaut and Oman."²⁴ In fact, the ancient Greeks made no distinction between the mother country

and her colony, calling them both "Ethiopia". Houston uses linguistics and physiognomy to support her contention. "A proof that they [the original Arabs] were Hamites [descendants from the Biblical Ham, from whom the black race is said to have sprung] lay in the name Himyar, or dusky, given to [those that were] the ruling race. The Himyaritic language, now lost, but some of which is preserved, is African in origin and character. Its grammar is identified with the Abyssinian" (Abyssinia being another name for Ethiopia).²⁵ Finally, Houston quotes the *Encyclopedia Britannica's* article on Arabia; "The inhabitants of Yemen, Hadramaut, Oman and the adjoining districts [in Arabia], in shape of head, color, length and slenderness of limbs and scantiness of hair, point to an African origin."²⁶ Stone engravings thousands of years old as well as modern photographs of Arabians bear testimony to the black African characteristics bequeathed Arabia by the original Arabians, the Cushite Ethiopians.²⁷ According to Houston, "The culture of the Saracens and Islam arose and flourished from ingrafting Semitic blood upon the older Cushite root."²⁸

As may be expected, W. E. B. DuBois makes some interesting points regarding the use of the word "Arab." Having noted that many Arabs are "dark-skinned, sometimes practically black, often have Negroid features, and hair that may be Negro in quality,"²⁹ DuBois reasons that "the Arabs were too nearly akin to Negroes to draw an absolute color line."³⁰ Finally, DuBois concludes that the expression Arab has evolved into a definition that is more religious than racial. "The term Arab is applied to any people professing Islam, . . . much race mixing has occurred, so that while the term has a cultural value it is of little ethnic significance and is often misleading."³¹

In his native Arabia, Mohamet rallied great numbers of warriors and set out to subdue the east. Mohamet's death in 632 A.D. did not stop the tremendous onslaught of his Arabian knights. They would eventually reach west to the Atlantic Coast of Africa, northwest to France and Spain, north to Russia and east to India.

The jihads or crusades through north Africa claimed Egypt in 638, Tripoli in 643 and southwest Morocco in 681. With the bulk of north Africa united in the name of Allah, Mohamet's followers looked north to Iberia, "land of rivers," now known as Spain and Portugal. The Arab followers of Mohamet had found converts among the African Moors, both black and tawny, and both Arab and Moorish officers were later to lead the predominantly Moorish soldiers into Iberia. In fact, the followers of Mohamet amassed their greatest armies and some of their most outstanding military leaders from the Moors.

An Arab general named Musa Nosseyr was appointed Governor of Northern Africa in 698 A.D. Although he cast covetous eyes towards Iberia, he hesitated, knowing that a campaign on Iberia could exhaust his armies. The Visigoths, who had earlier toppled the Roman Empire in Iberia, had ruled for over two hundred years. The Visigoths were a vigorous, rather barbaric people who, as Christians, believed in religious compensation for their vices. Over



Figure 5. A Moorish commander of the Black troops. This Moor is of mixed African and Arabian blood.

time they had become "quite as corrupt and immoral as the Roman nobles who had preceded them."³²

Yet another obstacle stood between Musa and Iberia. An outpost of the Greek Empire, the fortress of Ceuta, rested on the northern tip of Morocco. This door to Iberia was guarded by Count Julian, an ally of Roderick, ruler of Iberia. Count Julian fought off all Arab/Moorish attacks, and his fortress remained impregnable until Julian, for personal reasons, switched his allegiance from Roderick of the Visigoths to Musa Nossseyr of the Moors.

Tradition has it that Roderick, while responsible for Julian's daughter's welfare during her training at his court, broke his trust and took advantage of her sexually. Julian, furious at this betrayal, quickly reclaimed his daughter and sought out Musa. Julian proclaimed to the Arab governor his intent to ally himself completely with Musa for the purpose of conquering the rich lands of Spain. He offered his own ships along with his knowledge of Roderick's defenses. While consulting with his Khalif, Musa sent an exploratory mission, of five hundred soldiers led by the black Moor Tarif. After the reconnaissance mission returned, a success, in July of 710, Musa prepared to conquer Spain in earnest.

Sources indicate that Musa selected another black Moor to lead the attack on Spain. DuBois writes "Tarik-bin-Ziad . . . became a great general in Islam and was the conqueror of Spain as the commander of the Moorish army which invaded Spain."³³ Stanley Lane-Poole, author of *The Moors in Spain*, also makes reference to "the Moor Tarik with 7000 troops, most of whom were also Moors [were sent] to make another raid . . ."³⁴

On April 30, 711 A.D., Tariq crossed the straits of Hercules with his 7000 men, of which "6700 [were] native [Moorish] Africans and 300 [were] Arabs."³⁵ After landing on the Spanish coast, Tariq seized a great cliff and a portion of land around it. Deeming it strategically important, he directed the building of a fortress on the site. Tradition holds that his men named the fortress after him out of admiration and respect. The name Gabel Tariq, or General Tariq, was later corrupted to "Gibraltar", and its fortress known as the "Rock of Gibraltar." Tariq, leaving his fortress, ventured on to capture Algeciras and Carteya. Along his way through the country-side, he found many Spanish natives eager to join him against the ruling Visigoths. His army, rather than diminishing through attrition, actually swelled in size. "On 18th July of the same year, 711, Tariq with about 14,000 troops engaged Roderick at the head of some 60,000 troops at the Janda Lagoon by the mouth of the Barbate."³⁶ Before the battle, knowing they were greatly outnumbered, Tariq addressed his soldiers: "My men, whither can you flee? Behind you lies the sea and before you the foe. You possess only your courage and constancy for you are present in this country poorer than orphans before a greedy guardian's table. It will be easy to turn this table on him if you will but risk death for one instance."³⁷

Tariq's army won the day and proceeded to capture Ecija, Toledo, Archidona, Elvira, Cordoba and Murcian Oribeula. According to one source, "Toledo was actually handed over to the invading Tariq by the Jews of that city, who also supplied him with arms and horses. Wherever Tariq went, he and his troops were welcomed as deliverers from the tyranny of the Visigoths."³⁸

In 712, Governor Musa rallied 18,000 soldiers, primarily Berbers, and crossed the straits to lend support to Tariq. Musa himself captured Cremona, Carmona, Sidonia and Medina, while his son Abd-al-Aziz took Seville, Beja and Nieblu. Roderick made a final attempt to regain control in 713, but to no avail. "Tariq, having been supplied with reinforcements by Musa, finally crushed Roderick on the mountain range of Segoyuela . . ."³⁹ Roderick's death after this battle marked the close of the Visigoths' rule in Spain. According to tradition, Roderick was entombed at Vizen in present day Portugal.

The historical record clearly shows that the campaign on Spain was orchestrated by a black African general and carried out by predominantly black African troops. DuBois makes the point that "Spain was conquered not by Arabs, but by armies of Berbers and Negroids, [at times] led by Arabs."⁴⁰

The Arab/Moors in Spain were strikingly benevolent after their victory. The natives were not beset by Moors to change their customs, language or religion.⁴¹ The Spanish "retained their Romance tongue and enjoyed complete civil independence with their own churches, laws, courts, judges, bishops and counts. The Islamic authority insisted only on the right to approve bishops . . ."⁴² Only the Berbers, who had helped conquer the land, appear to have been unfairly treated by the Islamic state, a fact which later led to a Berber revolt throughout the empire.

The first Moorish Dynasty, the Umayyad, ruled Spain, or Al-Andulus as they called it, from 715 to 750. Although some expansion of the empire occurred (Lyons, Macon and Chalons-sur-Saone were taken in 729), the focus during this period was an internal consolidation rather than external conquest.

Many rival Moslem factions threatened to undermine the unity of Islamic authority in Spain. The last Umayyad Khalif met his death in Mesopotamia in 750, assassinated by a Shiite Moslem. Seventy members of the royal family and court also met their death in Damascus at the Shiites' hands. A new Khalif, A Bu'L Abbas, assumed the throne and founded the second Moorish Dynasty, the Abbasid.

Abdurrahmon, a nephew of the former Khalif, fearing for his life, fled into exile for five years. During this time he rallied primarily African Moors together, with the aim of creating an army to lead against Spain's new Khalif. Finally, in 756, he sailed back to Spain to pit himself against the ruler Yusef. "The governor of Spain was an Arab named Yusef . . . Abdurrahmon landed in Spain, and Yusef . . . tried to come to terms with him by an offer of



Figure 6. Arrival of a Moorish dignitary (16th or 17th century).

attractive presents. Abdurrahmon declined the offer, and both armies clashed on May 15, 756 at Musara and the African won the day.⁴³ Thus, the Umayyad Dynasty was resurrected in Spain.

More than simply a capable military commander, Abdurrahmon proved to be a humane and effective administrator as well. Under his leadership, Spain experienced a dramatic and positive change. By ushering prosperity into Spain, Abdurrahmon laid the groundwork for the splendid edifice of Moorish cultural accomplishment erected by later generations.

Land reforms were carried out which eased much of the tax burden formerly placed on the serfs. Another reform gave serfs the option of selling their property. Abdurrahmon solved the potential religious conflicts by treating Moslem, Christian and Jew alike; "side by side with the new rulers lived the Christians and Jews in peace. The latter, rich with commerce and industry, were content . . . Learned in all the arts and sciences, cultured and tolerant, they were treated by the Moors with marked respect, and multiplied exceedingly all over Spain; and like the Christian Spaniards under Moorish rule, . . . had come to thank their new masters for an era of prosperity such as they had never known before."⁴⁴

Under the auspices of Abdurrahmon and his descendants, the Moors developed a culture which in time would awaken all of Europe from its dark age. The Moorish culture was a composite culture, since the Moors indulged themselves in the acquisition of knowledge from both East and West. By the 7th and 8th centuries the ancient civilizations of Egypt, Harrappa, Akkad and Cush had long since handed the batons of philosophy and science to the Greeks, Hebrews, Chinese, Indians and Persians. But through these younger civilizations, the Moors learned from the older cultures.

The Moors would have benefited in their search for knowledge from the world's great library of Alexandria, in Egypt. Unfortunately, it was long since destroyed. History has recorded the incident: "The great library of Alexandria, accidentally damaged by Julius Caesar and restored by Mark Antony, was intentionally destroyed by a Christian mob on orders of the Christian emperor Theodosius in A.D. 389."⁴⁵ The library at Alexandria had constituted the storehouse of knowledge of the ancient world.

In spite of this, the Moors set out to quench their insatiable thirst for knowledge by "translating into Arabic all they could lay hands on of ancient Greek and Sanskrit material, ransacking monasteries for rare coupies of Euclid, Galen, Plato, Aristotle and Hindu sages."⁴⁶

An entire book could easily be filled with the accomplishments of Moorish culture; unfortunately, neither time nor space permits such an undertaking here.

But, briefly, it can be said that they excelled in many fields. Their achievements in the sciences were spectacular. The Moors were the first to trace "the curvilinear path of rays of light through air;"⁴⁷ this discovery in about 1100 is a



Figure 7. Moors in Morocco (dated 17th century).

prerequisite to the design of corrective eyeglasses. Towards the end of the 8th century their endeavors in chemistry brought them to the formulation of the chemical components of gun powder. Through its Harrapan inheritance, India made clear to the Moors some principles of astronomy. "The world is round as a sphere, of which the waters are adherent and maintained upon its surface by natural equilibrium. It is surrounded by air and all created bodies are stable on its surface, the earth drawing to itself all that is heavy in the same way as a magnet attracts iron. The terrestrial globe is divided into two equal parts by the equinoctial line. The circumference of the earth is divided into 360 . . . the earth is essentially round but not of perfect rotundity, being somewhat depressed at the poles . . . This is the Indian calculation."⁴⁸ These principles, recorded in a Moorish translation of an Indian text, would not be comprehended by the rest of Europe for 400 years.

The Moors pursued practical applications as well as the natural sciences. "The use of the astrolabe and the compass, revived again at a later period in Europe, were common to [Moorish] navigation."⁴⁹ European military science was revolutionized by the introduction of artillery and firearms. The Moors were also known for their skill in medicine; "For seven centuries the medical schools of Europe owed everything they knew to [Moorish] research. Vivisection as well as dissection of dead bodies was practiced in their anatomical schools, and women as well as men were trained to perform some of the most delicate surgical operations."⁵⁰ They amassed much information in the study of the functions of the human body and cures of its diseases.

Moorish Spain also excelled in city planning; the sophistication of their cities was astonishing. According to one historian, Cordova "had 471 mosques and 300 public baths . . . the number of houses of the great and noble were 63,000 and 200,077 of the common people. There were . . . upwards of 80,000 shops. Water from the mountains was . . . distributed through every corner and quarter of the city by means of leaden pipes into basins of different shapes, made of the purest gold, the finest silver, or plated brass as well into vast lakes, curious tanks, amazing reservoirs and fountains of Grecian marble."⁵¹ The houses in Cordova were air conditioned in summer by "ingeniously arranged draughts of fresh air drawn from the garden over beds of flowers, chosen for their perfume, warmed in winter by hot air conveyed through pipes bedded in the walls. Bathrooms supplied hot and cold water and there were tables of gold, set with emeralds, rubies and pearls."⁵² This list of impressive works appears endless; it includes lamp posts that lit their streets at night to grand palaces, such as the one called Azzahra with its 15,000 doors.

Such a well-developed culture depends on the efforts of talented people. A black African Moor named Zaryab is representative of the fullness and variety of Moorish culture.

Zaryab was a "renaissance man" before the Renaissance. He entered the country of Al-Andulus in 821. He was skilled in both arts and sciences. A



Figure 8. Remake of a sketch of a Moorish sultan and an emissary. Remade in 16th century Spain from a 14th-century original.

celebrated musician, he is credited for improving the lute by adding an extra string, making five in all, and also for founding a great school of music. A botanist as well as a musician, it is Zaryab whom asparagus-lovers may thank for the introduction of this delicacy to Europe. In addition, Zaryab excelled as an astronomer and geographer. According to one historian, his memory was prodigious; "He was, moreover, gifted with so much penetration and wit, he had so deep an acquaintance with the various branches of polite literature, he possessed in so eminent a degree the charms of polite conversation and the talents requisite to entertain an audience . . . that there never was either before or after him a man of his profession who was more generously beloved and admired. Kings and great people took him for a pattern of manners and education, and his name became forever celebrated among the inhabitants of Andulasia."⁵³ Zaryab evidently was an innovator within fashionable circles: "Zaryab was a leader of fashion in the most civilized court of Europe in the early half of the ninth century."⁵⁴ He "set the fashion of changing dress for four seasons of the year instead of for only two as was the custom before his day."⁵⁵ Being a connoisseur of food and drink and its accoutrements, "He . . . introduced the fashion of being served on crystal instead of on gold or silver . . ."⁵⁶ Some of Zaryab's fans were very highly placed; according to one historian, "He was reknowned throughout Spain, and on one occasion, when he came to Cordova, the Sultan himself, to show the respect which he held [for Zaryab] rode out to meet him."⁵⁷

With the contributions of individuals such as Zaryab, Spain flourished. But amidst the beauty and wealth, a socio-political plague was spreading: "Jews who had . . . been slaves now began trading in slaves."⁵⁸ According to T. B. Irving, between the years of 786 and 1009, "Franks and Jews traded Slavs and Germans who had been taken prisoner . . . on the Frankish territories. Thus "slav" and "slave" became interchangeable [terms] . . . They [the Franks and Jews] made young boys into eunuchs at Verdun . . . The slaves were driven from France to Spain in great herds like cattle. When they reached their destination, the men were purchased as servants or laborers, the women as household help or concubines . . . Many women were also imported from Galacia, for their blonde appearance attracted the Arab gentlemen. Slaves were also traded from out the Adriatic. These captives too were Slavs, and their merchants chiefly Christians."⁵⁹

This slave trade changed the racial mix in Al-Andulus. The use of European women as concubines gradually lightened the complexion of Moorish Spain. "Through these various processes [Moorish] Spain became more Caucasian in blood than is generally realized . . . It was always blond women, whether Slavs, Germans or Galicians, who were in special demand."⁶⁰ This practice was not exclusive to Spain; W. E. B. DuBois notes that during the 16th century "the Mohammedan rulers of Egypt were buying white slaves by the tens of thousands in Europe and Asia and bringing them to Syria, Palestine and the Valley of the Nile."⁶¹



Figure 9. A Moor in Morocco (dated 1841).

White slavery became widespread in Spain, Africa and the Mediterranean. The polygamous family structure common to many African cultures expedited the process of amalgamation and the consequences wrought havoc upon the inhabitants of Al-Andalus. Licentiousness and immorality became more and more prevalent in the Moorish social structure. Predictably, there was a gradual eroding of virtues, philosophy and the pursuit of cultural excellence. Though Abdurrahman did not encourage or personally patronize the slave trade, its continued persistence within his empire inevitably led to its collapse. Concerning this matter it has been said: "This penetration [of the black race by the caucasian] was facilitated not alone by the dominant position of the African race, but also by its tendency to polygamy. Abdul-Aziz-Ibn-Muza not only wed the widow of Roderico, [for which he was murdered by the Arabs] but took many Christian virgins for his concubines. On the other hand, Romiro II of Leon, fascinated by the beauty of a Saracen maid . . . slew his legitimate wife and married the exotic creature by whom he had a numerous progeny. The two cases were typical: On the one hand, a violent penetration of the conquered people by the polygamous invader, through their womenfolk; and on the other, the attraction exerted by the Saracen women, . . . upon men of the defeated race."⁶²

Abdurrahmon was succeeded by a series of comparatively ineffectual rulers. His son, Hisham I, ruled from 788 until 796. "During his reign, the Christian independent kingdom of Asturias in Southern Spain . . . became a source of trouble with which Hisham had to deal."⁶³ He in turn was succeeded by Abdurrahman's grandson, Hakam I, who ruled from 796 to 822. This period was characterized by many minor social upheavals which lead to a series of revolts. Abd-al-Rahman III ruled from 912 to 961 and was followed by Hisham II who during his reign stepped down; in his place, Spain was ruled by one Al-Mansour from 981 to 1002. In 1009 civil disorder tore asunder the Empire of the Umayyads. Divided now into separate principalities, the Sultans ruled independently, one from the other, which caused great loss of both military and political power. This made them vulnerable to attack by hostile Christian factions. In 1031 the Khalif was dethroned and the Umayyad dynasty came to a close: "It had lasted for a period of two hundred and seventy years."⁶⁴

With the collapse of the Umayyad dynasty in Spain, the security of military and political structures also came to an end. The Moors found themselves at the mercy of Christian expansionists who had been waiting for the opportunity to recapture territories long lost. The rising threat of Christian intervention and dominance began to create an air of fearful consternation amongst the inhabitants of Al-Andalus.

During this period as fate would have it, a strong and powerful movement was stirring in the African Sahara. This force would proliferate so rapidly that it would consume in time all of the central and northwestern sections of

the continent, and play a major role in the history of the Spanish Moors.

As stated earlier, many of the Berber tribes had been forced into the deeper recesses of the desert.⁶⁵ "The consequence of many wars in Northern Africa had been to force down certain Berber tribes upon the confines of Negroland."⁶⁶ They eventually mixed with black Africans who occupied the same territories. This fusion brought into being some of the most proud, brave and fearsome clans of the desert who were identified by the wearing of a veil around the face. "From time immemorial," says Ibn Khaldren, "the Mobt-Themim (or Wearers of the Veil) had been in the Sandy Desert."⁶⁷

The Mobt-Themim formed seven orders of the northwestern desert and during the reign of the Umayyad dynasty they were "already a powerful nation obeying hereditary kings"⁶⁸ which ruled in what came to be known as the Desert Empire.

There came to the throne of this empire a black ruler of the name of Yahya Ibn Ibrahim. Being a muslim, he "tried to convert his subjects from their traditional African religion to Islam. Yahia and his subjets were not Arabs. They were indigenous African people."⁶⁹

In 1048 Yahya made his pilgrimage to Mecca, and upon his return brought back with him for the instructon of his people a religious leader, Ibn Yasin.

Ibn Yasin endeavored to instruct and convert Yahya's people but the lack of interest they had towards Islam coupled with the harshness and severity of its disciplines only served to aggravate them; finally they rebelled and cast out Yasin.

Ibn Yasin and his followers left and established themselves on an island in the Senegal River where they lived as recluses. "They became known as Al-Murabitun, which meant people of the ribat. It is this word . . . that became corrupted in Spanish as Almoravid."⁷⁰

In time his community attracted great numbers of people and "when their number reached one thousand, Ibn Yasin, . . . declared a religious war against their . . . non-muslim converts."⁷¹ This time they met with limited success; "The Almoravids converted numbers of Sudanese negros but gained no political control over them . . . Among the converts was the King of the Mandingos."⁷² In 1042 with Yahya serving as General they began to conquer West Africa and when their numbers were thirty thousand strong, Ibn Yasin invaded Sijilmasa which was his home and began to move northward towards Morocco which he also conquered."⁷³

However, misfortune plagued the Almoravids after this period. "Yahya died in 1056 and was replaced by his brother Abu Bakar,"⁷⁴ and the following year saw the demise of Ibn Yasin. Abu Bakar furthered his conquest until he had an empire which "extended from the Senegal in West Africa to Morocco on the Mediterranean coast."⁷⁵

In 1061 disorder broke out along the southern fringes of their Desert Empire and Abu Bakar hastened home to restore order, leaving his northern



Figure 10. Moorish woman bearing presents. She is a West African type, the type that dominated the Almoravid and Almohade dynasties in Spain (photo 1837).

territories under control of Yusuf Ibn Tashifin. Yusuf was Abu Bakar's cousin and so naturally was a black African. DuBois describes him: "Yusuf their leader [the Almoravids], was himself a Negro. The 'Roudh-el-Kartos,' a Moorish work, describes him as having 'woolly hair' and being brown in color."⁷⁶ Yusuf proved to be a wise and capable leader. "In the year 1062 Yusuf laid the foundation of the town of Morocco with his own hands, and not long afterwards declared the independence of the northern kingdom of which it was to become the capital."⁷⁷ Thus, a black Moor appropriately founded the city of Morocco.

By the year 1082, Yusuf had long been hailed as the supreme ruler of the northwestern portion of the African Plate. But in the interim from 1062 to 1082, much had transpired to the north and south of him. To the south in 1076 Abu Bakar had attacked, sacked, and pillaged the Empire of Ghana, bringing to a close one of the "glories of Sudanic Africa"⁷⁸ and to the north in Spain Alfonso VI took Toledo and "swore to drive the Arabs into the sea at Gibraltar."⁷⁹

Yusuf, content with the empire he had established in his homeland, apparently never once contemplated assault on Al-Andulus. But within the later half of 1082, hundreds of Moors and Arabs had flocked back to Africa to escape the tyranny of Alfonso and the persecution by the Christians. These men, "with tears in their eyes and sorrow in their hearts, had come to Yusuf to implore his protection."⁸⁰ Finally in 1083 the Governor of Seville, Al-Mutammed came and begged assistance against the Christians. Yusuf consented and amassed one of the most formidable armies seen by either Arab or Moor. "It is stated that when Yusuf crossed to Spain there was no tribe of the western desert that was not represented in his army, and it was the first time that the people of Spain had ever seen camels used for the purpose of mounting cavalry."⁸¹ Being that Yusuf was black, and the western portion of Africa was also predominantly black, it was only natural that the core of those he enlisted would be black. The author goes on to say, "Forming the army which fought at Zalakah in 1086 . . . were thousands of blacks armed with Indian swords . . . This battle drove the Christian forces out of southern Spain and laid the foundation for Yusuf's Spanish Empire."⁸²

Yusuf marched onward to Seville, where he found the state of its inhabitants abhorrent. "It strikes me," he commented, "that this man [meaning the King of Seville] is throwing away the power which has been placed in his hands. Instead of giving his attention to the good administration and defence of his kingdom he thinks of nothing else than satisfying the cravings of his passions."⁸³ Soon afterwards, Yusuf left Spain and returned to Africa. Later he was informed by his Generals that they [his army] were doing the whole of the fighting against the Christians "while the Kings of Al-Andulus remained sunk in pleasure and sloth."⁸⁴

This infuriated Yusuf and he ordered his Generals to conquer the Kings of



Figure 11. Moorish festival of circumcision. Painting done in 16th-century Spain, re-made in 1864.

Spain and set in their place Governors of their choosing. This officially ushered in the Third Moorish Dynasty of Spain, the Almoravid.

As Flora L. Shaw exclaims, "Once more a supreme Sultan [sat] upon the throne of Al-Andulus, his conquest and the dynasty which he founded must be regarded as an African conquest and an African dynasty. The Almoravids ruling in Spain were identically the same race as that which moving from the West established kingdoms along the courses of the Niger and the Senegal."⁸⁵

Yusuf ruled both Spain and Africa until his death in 1106, when he was succeeded by his son. Thus the Almoravid dynasty continued to reign with a double court, one in Africa and one in Spain.

For years the Almoravids carried on the splendor that had always characterized Moorish Spain. All taxes were abolished in Africa and trade flourished. "The Almoravid Empire was one of great prosperity and learning but lasted for only a century."⁸⁶ Yusuf's son, being inexperienced, lost the throne and the African dominion was overthrown in 1142; the Spanish dominion fell three years later in 1145. This gave rise to the second great African dynasty to rule Spain and the fourth and last Moorish Dynasty—The Almohade.

Under the Almohades, who also hailed from the western fringes of Africa, Moorish glory in Spain was well maintained. Great monuments were constructed, the most treasured being the Tower of Seville. Grand observatories as well as splendid mosques were built. "African rule in Spain was at its summit in the Almohade period during which the greatest philosopher of the middle ages reached his maturity. Abu-Al-Walid Mohammed ibn Mohammad ibn Rashd, has been known in the west by the name of Averroes. He was an African who lived in Spain. There were numerous outstanding African scholars in Spain throughout the Muslim period and because of them, no European country came close to Spain in terms of cultural brilliance."⁸⁷

Averroes lived from 1126-1198. "He was a celebrated medical scientist, jurist, Theologian and astronomer."⁸⁸ Many of his works because of their excellence, were translated into several languages and he developed a philosophy which came to be known as Averroism.

Averroes' heyday was the lull before the storm, for the dynasty of the Almohads had grown extremely passive amidst the lavishness in which they had grown accustomed. This gave new incentive to the Christians to rally their legions and subdue the Moors once and for all. "It is stated that no less than three million Moors were banished between the fall of Grenada and the first decade of the seventeenth century."⁸⁹ Valencia fell to the Christians in 1238; Cordova in 1239; Seville in 1260. Though the last dynasty had perished from Spanish soil in 1230 and the Moors exiled from a land nurtured by their culture and wisdom, their influence was felt in Europe's schools of medicine, mathematics, and philosophy for two hundred years. "At the moment of the final expulsion of the Moors from Spain, the Catholic Cardinal Ximenes ordered the destruction of the libraries . . ."⁹⁰ As one author so brilliantly

exclaims, "The misguided Spaniards knew not what they were doing . . . The infidels were ordered to abandon their native and picturesque costume, to assume the hats and breeches of the Christians, to give up bathing and adopt the dirt of their conquerors . . . The Moors were banished and for a while Christian Spain shone like the moon, with a borrowed light, then came the eclipse, and in that darkness Spain has grovelled ever since."⁹¹ So ended "the Empire of the Magnificent." The Moors had ruled Spain for 800 years.

Others have given a different analysis of the Moorish Empire's racial makeup and history. According to many European historians, all civilized Moors were actually tawny or white Moors, whose ancestry could supposedly be traced through olive-skinned Arabs to Europe herself. For example, although historian John Crow acknowledges that "Africa begins at the Pyrenees," he is quick to qualify this statement.

One must be careful here to specify that the Africa here referred to is not the lower part of the Dark Continent peopled by black men. It is northern Africa, the ancient homeland of the Iberians, of the Carthaginians, a semitic race, of the Jews themselves, and of the Moors, composed of many Arabic-speaking groups."⁹²

On the following page is a picture of some descendants of the Moors; the caption illustrates a curious perspective unique to European scholars: "*Young Tebbu women at the Bordai Oasis, Tebesti, Chad. Ethnologically they are a link between the Berber Tueregs and the Negros of the Sudan.*" Thus, the subjects "link" a racially mixed group, the Berbers, and an entirely black group of Sudanese negroes. In spite of their parentage, however, the women are described as follows: "*Although they are not Negros, many of them are dark-skinned and have negroid features.*"⁹³

For these historians, or for their audiences, much is to be gained from these elaborate constructs. The theme underlying all these inconsistencies is that white culture is superior to black. The technique in each case is to separate the black African peoples from their achievements. Thus the ancient Egyptians, architects, builders and scientists par excellence, are Mediterranean types; the Ghanese Kingdom, one of the most stable and developed in Africa after Egypt and Kush, was masterminded by a white royal dynasty. "The Kingdom of Ghana was of considerable age, having had twenty-two kings before the Hijra and as many after. The ruling dynasty was white but the people were black Mandingo."⁹⁴ Of such a statement there is no possible way to measure its absurdity. The Moors, whose military prowess conquered much of the East, and whose religion caught the souls of millions of people, are held to be white or swarthy, but never black. In each case, the race and its historical contributions have been divided.

Another tactic of European historians bent on affirming the superiority of their civilization is used in those cases where the origin of a culture has

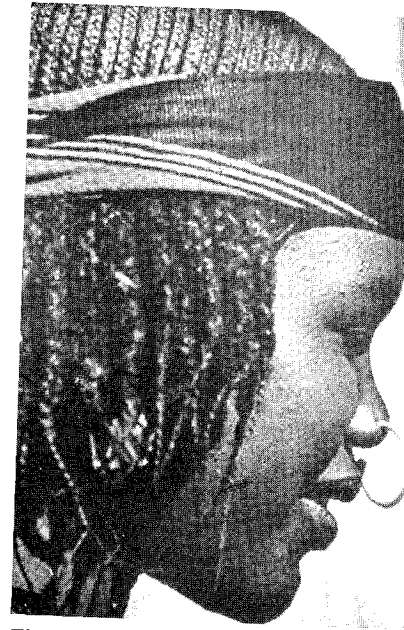

Figure 12 Tebu woman.



Figure 13. Tebu woman.

already been acknowledged as being black African. This tactic involves the denigration of the accomplishments of this black African civilization.

Yet another tactic of European historians has been to ignore African civilization altogether. "A History of Modern World" published in 1950, serves as a typical example of this approach. This 902 page book devotes a grand total of 8 pages to the history of Africa, or rather to the story of the partition of Africa following the 1805 conference at Berlin. As the text states on page 639, "in fifteen years the entire continent was parcelled out", with the exception of Ethiopia and Liberia. The remainder of the continent belonged to one of the European powers. The flyleaf of the cover, apparently unwittingly, gives the author's definition of the "world" mentioned in its title: the book is described as "a brilliant and highly readable history of Modern Europe in its international setting . . ."95

The same text will also serve as an example to illustrate another blindspot of European historians. The authors, who were educated and taught at Ivy League Schools, are aware of the impact of Europe on Africa, but not of any significant reciprocal current of influence. Thus the European colonization of Africa is discussed, but the influence of ancient Egypt on the Greek-Roman civilizations is ignored completely.

This essay has attempted to transcend the obstacles inherent in "discovering" African history. Napoleon's observation that "History is a set of lies agreed upon" is particularly apt in relation to African history. The challenge posed by this research was to sift through the prejudices discussed above, prevalent in much of the available materials, while stubbornly pursuing knowledgeable, objective sources, which seemed to be the least accessible. Amidst the ignorance, fabrication and prejudice lay pearls of truth regarding the bright achievements of Africans and African culture. This essay has deliberately placed emphasis on the role of black Africans in Moorish civilization rather than the civilization as a whole. During the research for this paper, however, it became clear that Moorish civilization—in its entirety—had suffered in the eyes of the world on account of its African heritage. In an attempt to set the record straight, highlights of Moorish achievements in general have been included.

Moorish civilization should take its place besides the other great African or African-influenced cultures—Egyptian, Harrapan, Kushite, and Olmec. Al Andulus had a special role to play in history. After the Roman Empire's collapse, Spain was like a riverbed gone dry; the rising sea of Moorish culture, saturated with the wisdom of the ages, replenished the river bed and formed a mighty waterway. This river of Moorish civilization, through its tributaries, regenerated the surrounding land that was medieval Europe, thus ushering in a great rebirth of cultural activity. Thus, through their gift of the renaissance the Moors constituted a link between the ancient civilizations and the modern world.

Notes

1. *The Oxford English Dictionary* (New York: Oxford University Press, 1977), p. 1846.
2. *The Oxford English Dictionary*, p. 900.
3. Hans Werner Debrunner, *Presence and Prestige: Africans in Europe* (Basel: Basler Afrika Bibliographien, 1979) pp. 19-20.
4. *The Complete Works of William Shakespeare*, edited by George Lymon Kittredge (Boston: 1936), p. 971, p. 1241.
5. Chancellor Williams, *The Destruction of Black Civilization* (Chicago: Third World Press, 1974), p. 221.
6. E.W. Bovill, *Golden Trade of the Moors* (London: Oxford University Press, 1968), p. 31.
7. Historical Atlas of Africa, Gen'l Editors J.F. Ade Ajayi and Michael Crowden (New York: Cambridge University, 1985), p. 16.
8. E.W. Bovill, p. 15.
9. E.W. Bovill, p. 15.
10. E.W. Bovill, p. 30.
11. E.W. Bovill, p. 31.
12. L.C. Briggs, *Tribes of London*, 1960, p. 34.
13. E.W. Bovill, pp. 34-37.
14. E.W. Bovill, pp. 30-31.
15. Budgett Meakin, *The Moorish Empire* (London: Swan Sonnenschein and Company, 1899), p. 6.
16. A. Rosalie David, *The Making of the Past: The Egyptian Kingdoms* (Turnhout, Belgium: Eisevier-Phaidon, 1975), pp. 13-14.
17. Gerald Massey, *Book of Beginnings* (London: University Books, 1881), p. 27.
18. W.E.B. DuBois, *The World and Africa*, (New York: International Publishers, 1972), p. 111.
19. E.W. Bovill, p. 29.
20. E.W. Bovill, p. 33.
21. E.W. Bovill, p. 38.
22. Stanley Lane-Poole, *The Moors in Spain* (London: T. Fisher Unwin, 1887), p. 3.
23. *African Presence in Early Asia*, Ivan van Sertima, editor (New Brunswick, N.J.: Transaction Books, 1985), p. 55.
24. African Presence, p. 55.
25. African Presence, p. 55.
26. African Presence, p. 55.
27. See illustrative photographs in Rashidi's introduction to *African Presence in Early Asia*, pp. 25-27.
28. African Presence, p. 56.
29. W.E.B. DuBois, p. 184.
30. W.E.B. DuBois, p. 184.
31. W.E.B. DuBois, p. 184.
32. Lane-Poole, p. 7.
33. W.E.B. DuBois, p. 183.
34. Lane-Poole, p. 13.
35. George O. Cox, *African Empires and Civilizations* (New York: African Heritage Studies Publishers, 1974), p. 134.
36. Cox, p. 135.
37. Cox, p. 135.
38. Cox, p. 135.
39. Cox, p. 135.
40. DuBois, p. 184.

- 41, 42. Cox, p. 136.
 43. Cox, p. 142.
 44. Cox, p. 143.
 45. Peter Tompkins, *Secrets of the Great Pyramid* (New York: Harper Celapnon Books, 1971), p. 3.
 46. Tompkins, p. 4.
 47. *A Tropical Dependency*, Flora L. Shaw (Lady Lugard).
 48. Shaw, p. 38.
 49. Shaw, p. 39.
 50. Shaw, p. 39. She later explains: "It is also interesting to note that in the great days of Moham-
 medan Spain, [Moorish] women were not confined, as in the East, to harems, but appeared freely in
 public and took their share in all the intellectual, literary, and even scientific movements of the day.
 Women held schools in some of the principle towns. There were women poets, historians, and
 philosophers, as well as women surgeons and doctors." Shaw, p. 49. An example of this was that the
 daughter and grandmother of the celebrated Moorish Pharmacist, Ibn Zohr, were both accom-
 plished female doctors.
 51. Shaw, p. 40.
 52. Shaw, p. 41.
 53. Shaw, p. 45.
 54. Shaw, p. 45.
 55. Shaw, p. 45.
 56. Shaw, p. 45.
 57. Shaw, p. 44.
 58. Cox, p. 144.
 59. Cox, p. 144.
 60. Cox, p. 144.
 61. W.E.B. DuBois, p. 52.
 62. Cox, p. 146.
 63. Cox, p. 147.
 64. Cox, p. 147.
 65, 66. Shaw, pp. 52, 53.
 67. Shaw, p. 53.
 68. Cox, p. 149.
 69. Cox, p. 149.
 70. Cox, p. 149.
 71. W.E.B. DuBois, p. 205.
 72. Cox, p. 149.
 73. *Tropical Dependency*, p. 55.
 74. Cox, p. 150.
 75. DuBois, p. 205.
 76. *Tropical Dependency*, p. 55.
 77. *Tropical Dependency*, p. 53.
 78. Shaw, p. 56.
 79. Shaw, p. 56.
 80. Shaw, p. 56.
 81. Shaw, p. 56.
 82. Flora Shaw, p. 56.
 83. Flora Shaw, p. 57.
 84. Flora Shaw, pp. 56.
 85. Cox, p. 151.
 86. Cox, p. 159.
 87. Cox, p. 154.

88. Cox, p. 154.
 89. Flora Shaw.
 90. Cox, p. 154.
 91. John A. Crow, *Spain: The Root and the Flower* (Berkeley & Los Angeles: University of Califor-
 nia Press, 1965), p. 6.
 92. Emil Schulthess, *Africa* (New York: Simon & Schuster, 1958), pp. 22-23.
 93. E.W. Bovill, *Golden Trade of the Moors* (London: Oxford University Press, 1968).
 94. In this example, Asia and the Americas are also given relatively short shrift.

MOORISH SPAIN: ACADEMIC SOURCE AND FOUNDATION FOR THE RISE AND SUCCESS OF WESTERN EUROPEAN UNIVERSITIES IN THE MIDDLE AGES

José V. Pimienta-Bey

To a number of Western historians the term "Moor" conjures up an image of a barbarous and fanatical people who threatened Christianity and even "civilization" itself. Such "medieval" followers of Mohammed are often regarded by myopic Western scholars as little more than efficient soldiers who, during the course of their conquest and international prominence, simply absorbed the superior cultural attributes of the peoples they conquered. Students of English literature would probably imagine the "Moor" as the fictional Othello, whose noble nature and naivete led this Shakespearean character into the blackness of tragedy. This image of the Moor was obviously conceived within the psyche of Britain's literary genius William Shakespeare, and Shakespeare was partly a reflection of the perception of English society at that time. Although both of these stereotyped images of the Moor carry elements of truth, there is a great deal more to his story.

Western scholarship has characteristically dragged its feet on the issue of the historical significance of the Moor. Very little has been offered within the classroom that has not resembled the two extreme images mentioned above. The Moor's largely obscure fate, however, is not due to his insignificance in the history and development of Western civilization, but, rather, to the judgement passed upon him out of jealousy at his great influence! The religious and ethnic/"racial" prejudices of several European historians seems to have prevented most contemporary histories from presenting a more thorough and balanced view of the Moor and Islam, especially as they relate to Christian Europe.

While most High School and College students are familiar with the Classical Renaissance of Europe — complete with Greco-Roman literature and the art of Michelangelo — few of them have ever heard of the scientific Renaissance in Europe which took place during the "medieval" era, in the 12th and 13th centuries. In my opinion, this is intentional. For behind Europe's "Scientific Enlightenment," we find many African Muslims. In fact, we find that the very foundation and structure of "Western" Science and Academe is built upon the erudition of these people known as Moors. Moorish influence primarily came to the West via the Iberian peninsula, later to be renamed "al-Andalus" by the

Moorish and Arab conquerors. But these non-European Islamic peoples would also occupy and control Sicily, parts of the Italian mainland, and Crete.

Using the fruits of ancient knowledge which these primarily Muslim people had preserved from the cultures of Kemet (Egypt) and Greece, the Moors (and Arabs) further developed the ancient wisdom as well as created new areas of science and philosophy. Initially, Arabian nationals had steered the ship of "Islamic Culture," which had taken on board various groups. But the contributions to the culture and science were not simply Arabian, although Arabic would dominate as the language of the educated Muslim, Moors included. Needless to say, not all of the achievements of Muslim erudition are traceably African. But as I shall show, much of the scientific genius of al-Andalus was of an African nature, primarily because the blood of Africans was most dominant among Iberia's non-European populace. Therefore, when we speak of the civilizing effect of Andalus upon the continent of Europe, we must visualize Africans (so-called "Blacks") as among the main civilizers.

Several histories have endeavored to weigh the value of the African Islamic intellectual presence within Western scholarship. This essay will provide a general overview of western Europe's scholarly relations with the Moors (and Arabs) of al-Andalus (Spain). It will begin with a discussion of the ethnicity of the Moors, and the confusion which surrounds this discourse. Following this, elements of the social and educational condition of al-Andalus will be provided as well as a number of references to her scholars and their achievements. Contrasts will also be drawn between Andalus and medieval Christian Europe. Another major aspect of this essay will focus upon Christian/western Europe's medieval tradition of translation, and the role which the Moors and the Arabic language played in developing the Western universities. Whenever relevant, the Catholic Church will be discussed. In addition, considerable emphasis will be placed upon Catholic Spain's Alfonso X and his school of translators, for if al-Andalus was the primary catapult of Moorish erudition, then Alfonso's translators would have certainly been the shot.

Learned and revered European scholars such as Adelard of Bath, Roger Bacon and Thomas Aquinas, represent just a few of Europe's erudite elite who came into considerable contact with Moorish knowledge. The historical reality of the medieval European's study of, and reliance upon, Moorish scholarship will be discussed. Besides Andalus/Moorish Spain, other avenues for western Europe's acquisition of Muslim scientific and philosophical skills will be outlined and evaluated. The ultimate consequence of European tutelage under the Moors (and other non-European peoples) of Andalus was the establishment and successful proliferation of academic institutions within the nations of Europe, and the progression of European societies as a whole. The extensive presence of Moorish scholarship within Christian Europe's finest medieval universities can easily be seen. To summarize, this essay will reveal medieval Europe's studies of, and reliance upon, Moorish scholarship and culture for the development of her own universities and societies.

The Question of Ethnicity:

“Los moros de la hueste todos vestidos del sirgo et de os panos de color que ganaran ... las caras dellos negras como la pez el mas fremoso dellos era negro como la olla”/ “All the Moorish soldiers were dressed with silk and black wool that had been forcibly acquired ... their black faces were like pitch and the most handsome of them was like (black as) a cooking pan.”¹

Those were the words of the thirteenth century Spanish monarch Alfonso X (also known as “The Wise”), in describing the Muslim invasion of Spain in the eighth century. At the time of the invasion the term “Moorish” (moros) referred to one specific African ethnic (national) group; even during the time of Alfonso it apparently carried that same single meaning. But by the end of Europe’s “Renaissance” eras it had taken on several applications. Today, multiple representations often come to mind when one hears the term “Moor” or “Moorish.” Moor/Moorish has even become a synonym for an “Arab” or “Berber” as well as a general term for any and all Muslims of the Middle Ages. The mere presence of such confusing ambiguity surrounding terminology and usage may actually provide some insight into how most Westerners *have chosen to remember* the Moors and their illustrious medieval-era culture. For in light of the general distaste which Western histories have typically had for dark-skinned Africans of any era, it is possible that much of the confusion surrounding just what a Moor was/is, may be the residue left by Western scholars who intentionally sought to hide or misrepresent the truth regarding the history and cultural significance of “Blacks” in western civilization.

Titus Burckhardt distinguishes himself with a fairly well detailed and illustrated confession of the Moorish roots of western Europe’s intellectual and cultural development. Burckhardt reveals this in his text *Moorish Culture In Spain* (trans by Alisa Jaffa, N.Y. McGraw-Hill Book Co., 1972). Yet, this German-born historian lapses into a racist stance when he contends in his Foreword that the reference “Arabic Spain” would be more appropriate than “Moorish Spain,” since the Muslim inhabitants spoke Arabic. Why is there any need to disconnect the description “Moorish” from Spain? Interestingly, Burckhardt doesn’t tell us how or why Andalus/Iberia came to be known first and foremost as *Moorish* Spain. Ironically, he tells us later that “Moor”/“Moorish” comes from the Latin term *Mauri* which means “BLACK”/DARK in complexion!²

In a number of histories the Moors of medieval Andalus are often associated with the “Berber” peoples of contemporary North Africa (Maghrib). Several Western historians frequently point out how the phenotype of the more modern-day “Berber” often bears a great resemblance to the “typical” European/“white.” Fair skin, straight or slightly curly hair, and aquiline noses, are commonly presented as the predominant standard of the present-day “Berber.” These phenotypical “Berbers” are regarded not as the only types but as the

unchanged descendants of the illustrious Moors of the Middle Ages. But is this appropriate? Is there only one standard phenotype for what a “Berber”/Moor was and is? Have the Moors/“Berbers” always been primarily akin to a “White” phenotype, or is this the result not only of later intermixtures but also of a later Eurocentric academia which effectively imposed this perspective in the interest of its own racial politics? [see illus. 1]

The term *Berber* is believed to have come from the Latin word *barbari* which the Romans used to categorize all the indigenous peoples of northern and western Africa (*Mauretania*) who *resisted* their invading Imperial armies.³ Following the establishment of the religion of Islam in the 7th century, Arabian nationals are said to have then adopted the Roman term as their own designate for these indigenous Maghribi peoples, which they too encountered in trade and war. The Afabs are said to have altered the reference only slightly and *barbari* became *Berber*.⁴

Cheikh Anta Diop presents another assessment of the term “Berber” and the origins of the Moors. Dr. Diop contends that the term “Berber” is etymologically tied to the term *ber* which implies that the “Berbers” were foreign. He writes:

The root of this word (berber) was probably of Negro rather than Indo-European origin. In reality, it is an onomatopoeic repetition of the root Ber. This kind of intensification of a root is general in African languages, especially in Egyptian.

He continues:

Moreover, the root Bar in Wolof, means “to speak rapidly,” and Bar-Bar would designate a people that speaks an unknown language, therefore a foreign people.⁵

Dr. Diop also goes on to say that the Moors are descendants of “post-Islamic invaders.” He states:

starting from Yemen, (the Moors) conquered Egypt, North Africa, and Spain between the seventh and fifteenth centuries. From Spain they fell back on Africa. Thus the Moors are basically Arab Moslems whose installation in Africa is quite recent. Numerous manuscripts preserved by the principal Moorish families in Mauritania today, manuscripts in which their genealogy is minutely traced since their departure from Yemen, testify to their origin. Moors are therefore a branch of those whom it is customary to call Semites.⁶

Dr. Diop may or may not be correct in his assessment of the origin of the word *Berber*. However, what needs to be questioned is the criteria by which certain Africa-based peoples have been placed in the category of “Berber.” Another important question is how long the term has been used.

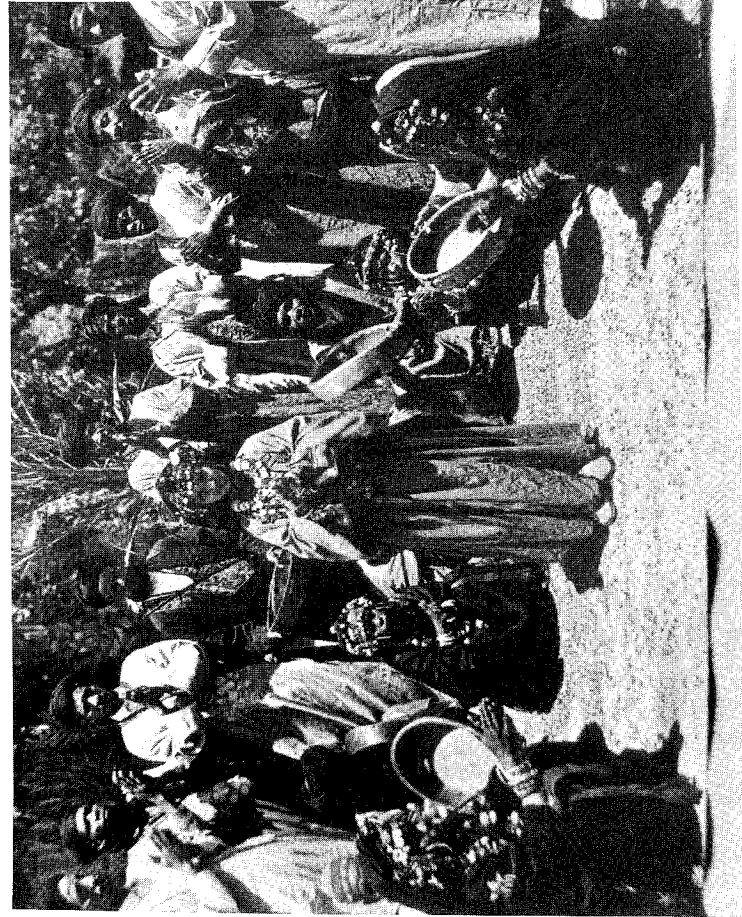

Figure 1. A Moroccan "folklore" group which would commonly be categorized as "berber." Note the distinct Africoid features. [From a Moroccan Tourist book: Morocco Tangiers, Ministry of Moroccan Tourism, 1988]

I was a bit disappointed with Dr. Diop on his brief assessment of the Moors. For a man who so often analyzed words and their significance, Diop failed to address the etymology of the word "Moor." Wayne B. Chandler in his essay: "The Moor: Light of Europe's Dark Age," informs us that the English word "Moor" originally comes from the Greek adjective "Mauros," which literally means "black" or very dark in color. The Romans would later adopt the word as a reference for the black-skinned inhabitants they encountered in Africa. Again, we recall that it was the ancient Romans who called the entire region of northwestern Africa *Mauretania*.⁷ Needless to say, this translates from the Latin as "the land of the black-skinned people."

On the issue of the Moors coming originally from Yemen in the seventh century, Diop himself tells us that Yemen "was a Negro Ethiopian colony and remained so until the birth of Mohammed."⁸ He also informs us that Ghez/Ge'Ez, the language of Abyssinia, "is a living remnant of the ancient language of Yemen."⁹ With regard to the "Arab" element of the Moors and Africa's Islamic culture, Diop says that "When Mohammed was born, Arabia was a Negro colony with Mecca as its capital."¹⁰ He adds: "the entire Arab people, including the Prophet, is mixed with Negro blood. All educated Arabs are conscious of that fact."¹¹ Diop even discusses ancient Kemetic practices of worship which strangely resemble some major elements of Islamic traditions.¹² All these facts compel us to reevaluate the significance of Diop's initial inference that (1) the Moors and Berbers are unequivocally one and the same, and (2) these people, Moors/Berbers, are foreign to Africa, and therefore non-African. We will come back to Diop later.

Richard Brace sheds additional light upon the origins of the Moors, and the apparent synonymy of the term "Moor" with "Berbers." Although Brace doesn't specifically say whether he considers "Berber" to be synonymous with "Moor," one can see the correlation when Brace writes: "The Berbers came to the Maghrib at least as early as the second millennium B.C., sixteen centuries before the Arab conquest ... it is judged that they came from the east, perhaps the Red Sea or Egypt, (emphasis mine) possibly further."¹³ Brace also maintains that their language was "Hamitic" and is related to the ancient Egyptian.¹⁴ In discussing the racial/ethnic foundations of Morocco, Brace says nothing of "Moors," preferring to use only the term "Berber." But Brace's designation of the "Berber" language as "Hamitic," is most telling, as it thereby associates the people with distinctly African origins.

It is significant to note that the term "Moabitarum" is very frequently used by medieval-era European writers to describe the "Moorish" inhabitants of northwest Africa or *Mauretania*.¹⁵ Those who are familiar with both the Koran and the Bible would recognize the references "Moab"/"Moabite." The descendants of Moab, the Moabites, were an ancient people who occupied a significant portion of Palestine (See Gen: 36:35 & Exodus 15:15). This item will prove to be even more significant as we proceed.

In discussing the entrance and admixture of Africa's 7th century invaders into the Iberian peninsula, Spanish scholar Enrique Sordo writes:

The Berbers were no strangers to the peninsula. They formed the largest part of the invading force, and much intermarriage rapidly brought about a relatively coherent Hispano-Moorish group.¹⁶

Sordo is clearly implying that the term "Berber" and Moor are always fully synonymous, since he makes no reference to the ethnic term Moorish — the linguistic root for which the country of Morocco was named, and the land from which the "Berbers" entered the Iberian peninsula. But Sordo's implication is something which I am not fully comfortable with, in light of Dr. Diop's contention that "Berbers" evidently have some cultural and "racial" connections to Europe. Diop, for example, thinks that the name Aoudaghost (a Moroccan city) sounds very Germanic,¹⁷ thereby suggesting some European connection to the history of northwestern Africa.

Joseph McCabe was a European-American historian during the 1920's and 30's who spoke very highly of the Moors and their cultural influences upon Western civilization and indeed, the world. He stated:

The story of the Moors and their service to the race (humanity) is so large and important, so inadequately recognized by most historians, and so wholly concealed by religious writers, that I should like to devote at least six of these little volumes to it.¹⁸

While discussing the ethnicity of the Moors, McCabe writes that:

the Arabs were settled amongst the Moors ('Blacks' — though the Berbers of Morocco are merely swarthy whites, not blacks) ... no doubt they intermarried with them, so to Europeans they (the Arabs) became known as Moors.¹⁹

Although one might be repelled by McCabe's seemingly oxymoronic reference to "Berbers" as "swarthy whites," one must again consider the reality of several present-day "Berber" designated phenotypes and complexions, as well as Diop's revelations of a European connection to those known as "Berbers." However, McCabe submits that the MOORS were (are) "Blacks"/"Negroes" as we see by his placing "Blacks" in quotations and parentheses next to MOORS. The picture that appears to be developing regarding the relationship between "Berbers" and Moors in the European mind, is one of gradations of color, similar to what the U.S. and several European (European controlled) societies did with Africans of varying mixtures and phenotypes. Terms like "Quadroon," "Octoroon," "Mulatto," "Creole," & "Mestizo," all remind us of European-American attempts (all too often successful) to divide up peoples of African blood/ancestry. The notion of such a *Pigmentocracy*, as my Uncle John often calls it, has evidently been evident in the "scholarship"

of several European writers on the Moors. It is beginning to appear that "Berber" is to "Moor," what "Mulatto," "Quadroon" or "Octoroon" were to "Negro" in the not-so Old southern United States.

In discussing the origins of the Moroccan peoples, Brace speaks only of "Berbers." He writes:

Archaeologists tell us that the Berbers *are not an ethnically homogeneous race* ... scholars agree that they are white, most frequently dark-eyed.²⁰

Brace's use of the term "white" is no doubt based largely upon the lightness of some of the Berbers. But I would question the criteria by which the vast majority of "Berber" peoples have been designated as "white," by such *scholarly agreement*. What (& Whose) scholars could agree to this, if the "Berbers" are so phenotypically non-homogenous — particularly when we consider that the degree of non-homogeneity is so extensive that Brace had to bring attention to the fact? Although one must recognize the presence of some light-skinned "Berber" peoples in "medieval," as well as present-day, Morocco (& the Maghrib in general), it is extremely necessary to reconsider the "racial" categorization of such present-day folk, as well as the appropriateness of designating light-skinned contemporary "Berbers," as the predominant phenotype during the cultural zenith of medieval al-Andalus! The peoples of present-day Morocco are primarily an amalgam of African, Arab, and European blood. In assessing all this, let us be mindful of two major facts: (1) African blood has dominated in the area for most of the region's long history of human settlement, in spite of the relatively minor settlements which spilled over from Visigothic Iberia (which probably explains Audaghost). (2) that the influx of any appreciable European people was a relatively recent colonial-era event. Now, how would most individuals with such admixtures be classified according to the presiding rules of "race" in the U.S. and most European/Eurocentric societies? Before answering this question, let us again review the geno-historic foundations of the Arabian people. [see illus. 2]

We have already noted that the Kushitic origins of the "Arab" people and how dominant the Africoid phenotype remained from antiquity until the time of the Arab Prophet Mohammed. While weighing the scholarship of the famed Spanish historian Miguel Asin-Palacios, James T. Monroe too alludes to the considerable bio-cultural correlations that existed/exist between African and Arab when he writes: "By indicating this influx of Arabic Philosophy into European thought, Asin was in a sense Africanizing Europe."²¹ Whether Monroe did this intentionally or subconsciously, it displays the degree of synonymity (geno-historically) between Africans and Arabs, which even European scholars can recognize.

Diop told us of the miscegenation which took place for many centuries between the Kushites and the Jectanides (a light-complexioned Asiatic people), which thereby produced the Arabs.²² Dr. Diop implies, however, that the de-



Figure 2. This Moroccan girl would commonly be categorized as “Arab” in Eurocentric and Arab nationalist circles. Yet, she is described as being part of a native “berber” people of Morocco. [Tour book: Morocco]

gree of intermarriage in Arabia begins to wane and becomes less apparent (phenotypically?) by the seventh century; the period of the establishment of the Religion of Islam.²³ But I would differ with such an implication. Although the famed eleventh edition of the *Encyclopedia Britannica* is somewhat dated (1911), it offers some insight into the Islamic Arab mentality and society in the early 20th century, just prior to its Westernization. Written by a British author, it stated:

Arabia has a considerable free black population and there again by intermarriage with the whites around, have filled the land with a mulatto breed of every shade till ... a white skin is almost an exception. In Arabia no prejudice exists against Negro alliances; no social or political line separates the African from the Arab.²⁴

Even today we can easily see the legacy of such intermarriage. Even Saudi Arabia’s present Ambassador to the U.S., Prince Bandar Bin Sultan, bears distinctly Africoid features (dark skin, woolly hair, full lips & a broad nose). If the Prince discarded his accent for that of a Harlemit or Philadelphian, he would certainly be perceived and accepted on 99% of America’s streets as a “Black” American, with or without his Arabic name! With regard to this, I think it is imperative that we begin to ask questions such as: (1) What role has the western/Eurocentric media played in shaping our perception of history and our modern world? Is there actually a desired phenotypic image which the News media prefers to show when covering “Middle Eastern” nations? (2) Just how deeply have we been SOCIALIZED INTO SEEING? Have our perceptions of other “peoples of color” been dictated to us?

In assessing the question of the Africinity of the Arab, I believe that the problem for many of us is one of geography. Arabia is not physically a part of the African continent and, therefore, her people are typically regarded as non-African, in spite of a long history of a predominant Africoid phenotype. When we fully consider the predominant “racial” interpretations of the present-day, the differences which exist between “Arab,” “Moor,” and even “Berber,” is primarily one of semantics and culture, not biology. While one might outline the differences of culture between the Andalusian African (Moor) and the Arabian national, the question of “racial” distinction is far less pronounced. Any “racial” confusion that exists is almost certainly the direct (or indirect) result of Eurocentric institutions and media. Whether by conscious individual choice or the ingrained influences of a prejudiced society, many Western-produced texts have deeply obfuscated a historical issue which need not be so obscure. The ethnicity/“race” of the people who established Andalus and flourished there for nearly 800 years, should not be an area of confusion anymore than the “racial” foundation of a place like Mexico. One must recognize that Spanish influences (i.e. religion, language, blood, and perhaps even worldview) began to affect America physically and culturally from the

sixteenth century onwards. This assimilation of race and culture ultimately culminated in Mexico. The historically conscious individual cannot intelligently assert that the glorious ancient Empire of the Azteca was born of Spanish culture or Spanish people. Similarly, one could not look at the present Mexican President, Salinas, and state that he is the most typical example of what the ancient Azteca builders looked like. One must take into account the historic reality of miscegenation with post-Columbian Spanish Conquistadors.

A look at many medieval European representations of "Moors" in art and literature, reveals that the Moors had as wide a range of physical appearance as do African-Americans today. But when one peruses such books of Heraldry as those of Charles A. Fox-Davies and James Fairbairn, with their illustrations of "Moors,"²⁵ it becomes evident that *the standard* for a Moor was most often very dark skin and woolly hair. For another major example, we need only to observe the words of Shakespeare's villainous Iago. Iago, the literary creation of Shakespeare's Elizabethan mind, says crudely to Othello's Father-in-law: "Even now, now, very now, an old Black ram is tupping (copulating with) your white ewe." (Act I, Scene I). Even Roderigo, a Venetian, refers to Othello "the Moor" as "thick-lips" in the same scene.²⁶ Clearly, what a MOOR phenotypically represented for English society in the early 1600's had a correlation with today's so-called "Blacks." What group has been so despised throughout European-dominated history for their full lips? Without a doubt, Africans. We can also see another stereotypical reaction of Europeans toward "Blacks," with regard to marriage or intimacy between European women and African men. (In spite of this revulsion, a powerful contrary attraction exists, as the history of intimacies between European men and African women attest).

In evaluating how the predominantly Africoid type in North Africa gave way to an amalgam of phenotypes, many of a Euro-African cast, we must consider the systematic, almost genocidal, destruction of many African peoples. Let us remember that, after the defeat of the Moors in Europe, the most distinctly Africoid types would have been the primary target of Europe's wrath and that the rationale for this may have been as much a consequence of the psycho-racial neuroses discussed in Frances Cress Welsing's theories,²⁷ as in simple material greed.

Perhaps, to the average European mind, the "blackest" Africans represented pale-skinned Europe's genetic inversion and nemesis. Consequently, such Blacks had to be systematically suppressed or annihilated. I would assert that the reality of European military domination and hegemony, coupled with its pigmentocratic worldview of "light superiority," compelled North African societies into placing a premium upon lightness of skin. The closer to the European phenotype, the better. The same pathologies which Africans in America developed, regarding preferences for light-skinned mates and offspring (in order to "lighten the race"), dominated the colonized peoples of North

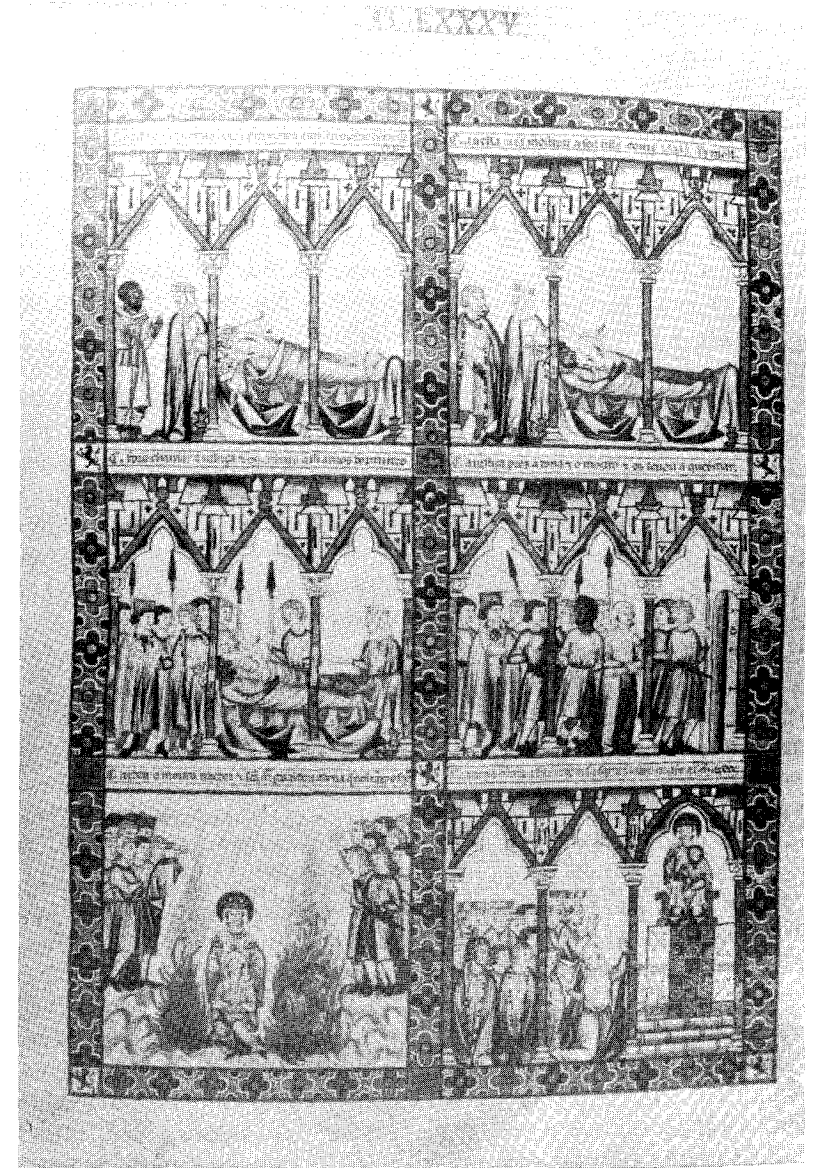

Figure 3. From Alfonso X's 13th century text, *Las Cantigas CLXXXV*, this comic-strip like illustration shows a Catholic Lady seducing a Moor into a trap. She lures the Moor with an invitation to her daughter-in-law's bed, only to turn the couple in to her son and the authorities. The Moor is burned alive and the daughter is spared by the "Virgin Mary."

Africa. But, in spite of all this, many of the original so-called "Berbers" of Morocco, who resemble distinctly Africoid/"Black" peoples, still survive. Shortly, we will see the grounds upon which European scholars have academically justified the use of the term "Berber."

In discussing the impact of one of Moorish Spain's two most significant African Dynasties—the Almoravids, British medievalist, De Lacy O'Leary, tells us that the dynasty's primary founder, Yahya Ibrahim, was "of a great Berber tribe of Latuna ... ONE of THOSE LIGHT-COMPLEXIONED BERBER RACES [emphasis mine] such as can still be seen in Algeria, and are apparently nearest akin to the Lebu, as they are represented in ancient Egyptian paintings."²⁸

O'Leary's statement clearly implies that there were (are) dark-complexioned ("Black") Berbers! The fact that this Irish historian, writing in 1922, would feel it necessary to qualify descriptively just what (pheno-) type of a "Berber" Yahya Ibrahim was, strongly suggests that O'Leary was seeking to exclude contemporary "Negroes" (often rumored to be racially connected with the Moors/"Berbers") from any correlation to the great Moors of the medieval period. Interestingly, O'Leary does mention one of the most significant of the Almoravids, *Yusuf Ibn Tashifin*, the ruler who succeeded Yahya and expanded the dynasty's dominion in Africa and Iberia.²⁹ Even the most anti-"Black" scholar could not deny the importance of Tashifin, or attempt to portray him as racially "white" (fair-complexioned "Berber"), as Tashifin's historical significance and distinct African features are too well documented in such Arabic sources as *Roudh el-Kartos*.³⁰ Consequently, O'Leary chooses to remain strangely silent on the issue of a physical description of Tashifin and his fellow "Berbers," although he does inform us of how Tashifin extended Almoravid-"Berber" dominion "from the Mediterranean to the Senegal," and that the "Berber" Tashifin was a "Murabit" Prince.³¹

A Moroccan friend of mine who specializes in Linguistics, Professor Aziz Lotfi, presented me with some rather interesting information pertaining to the "Berbers" of North Africa and their origins. Professor Lotfi, who teaches at a Moroccan university, pointed out that Western scholarship has primarily defined the "Berbers" on linguistic grounds only, while consciously or unconsciously ignoring the ethnic/racial diversity of the "Berber"-speaking community.³² Citing *The World's Major Languages*, edited by B. Comries, Lotfi also points out that many of the "Berber" languages exhibit Kemetic, Kushitic, and Semitic origins, as revealed in their morphology, phonetics and word-orders.³³ Although some "Berbers" have been linked to Celtic and Nordic origins by a number of French writers of the colonial period, Lotfi demonstrates that the probability of "Berber" origins are more likely East African and Kushitic. He offers the following observations:

1) The Dra Valley of southern Morocco is largely regarded as having been inhabited long before the first Canaanite settlement of the 10th century B.C.,

by a Cushitic people whose descendants, the Haratins, represent *one of the largest* "Berber" speaking ethnic groups in Morocco.

2) Several Moroccan family names: Koush, Kouash, and Kashani, for example, all denote Kushitic/Ethiopian origins. (I might add that this also evidently explains the origin of the popular north African food "Cous-Cous," whose name evidently suggests an Ethiopian origin).

3) A prominent village, Misra, near the city of Fez, illustrates a connection to eastern Africa, as "Misra" (Misraim) is the name given to Egypt/Kemet by the Ethiopians/Kushites.

Not only do Prof. Lotfi's findings support my contentions about the synonymy between "Berber" and Moor (let us not forget that "Moor" even etymologically designates an Africoid phenotype), but a fascinating correlation is made between the Moors and ancient Kemites. This is something which will be expanded upon later.

Perhaps one of the most revealing observations of Prof. Lotfi was when he informed me that there is no Berber-speaking community in Morocco today, which identifies itself by any name or term which is "even distantly related, phonetically or morphologically, to the term "Berber." This is a "foreign" designation for what was mainly a "native" people.

Close historical inquiry and historiographical analysis reveal the "racial" relationship between the Black African of the eighth century (century of the Moorish invasion) and the historical Moor (the so-called "Berber") who entered the Iberian peninsula and profoundly influenced Europe. A look at any number of Europe's books of Heraldry (i.e. Fox Davies) or even the coats-of-arms revealed within the books of the late great J.A. Rogers, provides the pictorial evidence of what many a Moor was. Why do European scholars who discuss North African ethnic origins fail to address the question of why Morocco is called *MOROCCO*, or why Mauretania is called *MAURETANIA*? How can one single out a much later citizen of Morocco, now mixed with other races, and present him or her as a classic example of the phenotype which dominated in "medieval" times, during the Moorish occupation of Spain?

Before closing this section, let us look at a few more references and observations which European writers made regarding the Moors who entered Andalus, as many of their comments are quite revealing.

The 16th century European chronicler John Pory, said of the western Sudan: "This part of the worlde is inhabited especially by the *Africans or Moores, properly so called*; which last are of two kinds, namely white or tawnie Moores, and Negroes or blacke Moores."³⁵ From this quote we learn two primary things: (1) a considerable number of the African peoples of the western Sudan "properly" referred to themselves as "Moores"—regardless of whether they were light or dark in complexion. We can safely say it was clearly a general reference which they used (& accepted) when categorizing

themselves. (2) John Pory, this especially pigment-conscious 16th cent. European, chose to divide the Moores up into “blackes”/“Negros” and “whites”/“tawnie” — in spite of the “proper” reference which these Africans had holistically accepted for themselves: MOORES! Again, I think of U.S. history, and the Euro-American divisions of African/Africoid people which makes clear distinctions between “mulatto” and “negro.”

A European Catholic Priest’s account about the Moorish invasion of 710, written in 754, makes clear that the Catholic Europeans of this early era recognized a difference between the Moor and the Arab. But again, it is my impression that this difference was probably noted in cultural manifestations (i.e. language, dress, manner), and not ordinarily in phenotype/“race.” Taken from the “Continuatio Isidoriana Hispana ad annum 754,” it read:

Nam adgregata copia exercitus adversus Arabes una cum Maurois a Muze missos, id est Taric Abuzaara et ceteros diu sibi provinciam credit am incursantibus simulque et plerasque civitates devastantibus./trans: He gathered the full strength of his army to face the *Arabs* together with the *Moor*s sent by Musa [Musa ibn Nusayr, Governor of the Maghrib in 710 during the Moorish conquest of Iberia], that is Tariq ibn Ziyad [Governor of Tangier in 710, and second in command of the invasion] and the others who had for long been raiding the province assigned to him and despoiling many cities.³⁶

While discussing the illustrious Moorish conqueror Tariq and his 710 invasion, the “Chronicle of Alfonso III of Asturias (866–910),” clearly suggests some kind of synonymity between the Moors and Chaldeans. Within this document from 883, Alfonso III (a.k.a. “scientia clarus” — “famous in learning”) writes: “Qui dum Asturias peruenissent uolentes eum fraudulenter comprehendere, in uico cui nomen erat Brece, per quendam amicum Pelagium manifestum est consilio Caldeorum.”/trans.: “When they [Tariq’s soldiers] reached Asturias intending to take him [Pelayo, a Catholic Monarch] by trickery, in a village called Brece, Pelayo was told of the Chaldean’s plot by a friend.”³⁷ While it is possible that this reference was meant to be allegorical, it is also quite possible that this text actually illustrates that the Europeans of the medieval period were well aware of the “racial” (& historical?) connections between Africa’s Moors and the ancient civilization of the Chaldeans. This latter possibility should at least be considered — particularly since there is historical evidence to support such a contention.

As we proceed with the following sections, let us keep in mind that any references made to “Moors,” “Berbers,” and even “Arabs,” by western histories, should largely be perceived as equivalent terms for all of Andalusia’s predominantly African/Africoid populace (“peoples of color”). For, in spite of some medieval-era descriptives of Caucasoid Muslim & Christian personages, the bulk of the Andalusian society was most evidently African/Africoid. As we shall see, most histories assert that the largest newcomers to Andalus

were the so-called “Berbers,” more accurately Moors from Africa’s north-western Sudanic region. The fact that this medieval country is most often remembered as “MOORish,” as well as the earlier discussion regarding the ethnicity of Iberia’s Muslim newcomers, should validate this contention.

Social & Educational Realities of Andalus:

Historian Joseph O’Callaghan affirms that, “Probably no more than 18,000 Arabs entered the peninsula in the first wave of invasion; thereafter relatives and dependents of the Umayyads [the ruling dynasty based in Baghdad] settled in al-Andalus, but the number of Arabs did not increase appreciably.” He continues, “The Berbers were the most numerous of all newcomers to the Peninsula. About 12,000 crossed the straits with Tariq, but there was a steady influx from Morocco during the centuries of Muslim predominance.”³⁸ It would not be until the eleventh century however, that the “Berbers” would become the most influential political group in al-Andalus.³⁹ O’Callaghan also makes the point that the cultural and scientific impact upon the Iberian peninsula by the first Muslim settlers was not very significant. These Moors, Arabs, and even Persians, were preoccupied the first hundred years of so fighting Catholic armies (and even factions within their own ranks). But by the tenth century, Iberian-based Muslims began returning from Africa and Asia with the latest scientific and philosophical doctrines.⁴⁰

The ninth century had already witnessed the outnumbering of Christians by Muslims and Jews.⁴¹ For the most part, Andalusia’s Muslims were Sunnis who believed in the election of the Caliph (ruler).⁴² Initially, the Muslim peoples were concentrated within the southern region of Andalus as far north as Toledo. The area above Toledo was mostly a no-man’s-land with only a few Moorish settlers. Within the country a variety of berber and arabic dialects were spoken. But by the ninth century, Muslim expansion, complete with the peasantry’s large scale conversion to Islam, had resulted in the domination of the Arabic language. One ninth-century Spanish Catholic complained:

“Alas! All talented young men know only the language and literature of the Arabs and read and assiduously study the Arab books. If somebody speaks of Christian books they contemptuously answer that they deserve no attention whatever. Woe! The Christians have forgotten their own language, and there is hardly one among a thousand to be found who can write a friend a decent greeting in Latin.”⁴³

The Maghrib had received Arabic Islam during the period between 641 (Arab conquest of Egypt) and about 700 A.D.⁴⁴ Andalusia’s Moors had come into the country with a very religiously tolerant philosophy. Although these

Muslim people conquered and controlled al-Andalus, they allowed the Jews and Catholics to continue practicing their respective faiths. In assessing the treatment of Jews under Muslim control, O'Leary states that their prosperity continued and increased under Moorish rule. Very often they held high court positions and civil service jobs. O'Leary says that the Murabit (Moorish) rulers "took no measures against Christians or Jews."⁴⁵ The Christians and Jews suffered almost no persecution at the hands of the Muslims. The Muslims, however, fared very poorly under Christian domination.

In contrast, McCabe comments upon some of the more extreme examples of Catholic/Christian intolerance. He mentions the "burning alive of women and youth, and the tearing open of the bellies of accused heretics before 'delighted crowds' " in the Christian West.⁴⁶ In his writings McCabe clearly implies that Moorish atrocities rarely — if ever — rivalled those of the Catholics. Needless to say, the Moorish occupation of Iberia/Hispania is considered by most evaluative histories as vastly more civilized and industrious than the country had been under the Visigoths and Vandals (two Germanic tribes). Vives tells us that "the Hispani provinces were barbarically devastated by the Franks and Suevi [European tribes], their principal cities sacked and destroyed, the countryside razed without mercy."⁴⁷ Several histories record that the entrance of the Moors in 710, was welcomed by most of the Iberian peasant classes and Jews, who had been brutally subjugated by the Visigothic oligarchy. S.S. Imamuddin's work: *Some Aspects of The Socio-Economic and Cultural History of Muslim Spain: 711-1492* supports this thesis.

Brace maintains that "Arab imperialism was not based upon racial supremacy. It entered by force and impressed its culture because it appreciated what it found and did not fear that its ideas would become diluted by blood ties."⁴⁸ Tolerance was very much the creed of Moorish Spain. Conversion to Islam was not forced. Few Jews converted to Islam as they enjoyed freedom of worship and the right to live by their own customs and laws. The Chief Rabbi had complete jurisdiction over the Jewish community. As a result, the Jews prospered in various trades and they "were particularly active in the slave trade," writes O'Callaghan. It wasn't until the coming of the Almoravids in the eleventh century, that the Jews endured any notable persecution and began fleeing into the Christian dominions of Andalus as well as other Islamic lands.⁴⁹ One could wonder if Jewish persecution under the Almoravids had something to do with the considerable Jewish involvement in the enslavement trade. Still, the Jewish presence in Andalus is exemplified by uninterrupted prosperity for most of the 700 or so years of Moorish control. We might also note that it was only a generation after the Almoravids, with Andalus now under African Almohade control, that perhaps the greatest of Jewish philosophers, Moses Ben Maimon ("Maimonides"), rose to great prominence.

The constant warfare between Andalusian Muslims and Christian kingdoms had kept the slave trade alive in the Mediterranean. O'Callaghan tells us that:

"Negroes from the Sudan," and European slaves (saqaliba) Franks, Slavs, Germans, Norsemen and others filled the ranks of servitude. He points out very quickly, however, that Islam's brand of slavery cannot be compared with the more dehumanizing kind practiced by the Christian Europeans. In reference to Islamic slaves O'Callaghan writes, "Owners did not possess the power of life and death over them, nor could they inflict excessive punishments."⁵⁰ Slaves had *rights* and they could actually seek official assistance if they were exceedingly mal-treated. Any student of American history knows that this was far from the case regarding the British and U.S. system of Enslavement. The enslaved African was a non-human, legally designated as "property." Whoever it was that said "All human slavery has been precisely the same," is simply speaking from a position of extreme historical and cultural ignorance.

I feel that I must take a moment to comment upon the significance of O'Callaghan's use of the word "Negroes" when speaking of those slaves who were imported from the Sudan. Why does he not simply refer to them as "Sudanese?" After all, he is very careful about giving the nationality of all the European slaves. Whether Mr. O'Callaghan's statement was intentional or merely a conditioned response, it only feeds the process of historically denying phenotypically black-skinned Africans of a national origin.

In assessing the social mobility of al-Andalus, historian Anwar Chejne declares, "It should be emphasized that Andalusian society was flexible and open. A man of humble station, whether Muslim or non-Muslim could climb the social ladder and occupy any high position except that of supreme ruler."⁵¹ In contrast, the famed Arabist, Stanley Lane-Poole, criticized the elitist and powerful Christian clergy of Visigothic Iberia. He said, "The very clergy who preached about the brotherhood of Christians ... treated their slaves and serfs as badly as any Roman noble."⁵²

A number of the laws invoked by Christian/Catholic authorities were unjustly harsh. O'Callaghan gives an example of the *Usages* which gave the Catholic sovereign the specified right to cut off hands and feet, put out eyes, imprison, and hang. Regarding women offenders, the ruler could cut off their noses, ears, lips and breasts. Spanish Catholic monarchs like Alfonso VII punished criminals by lopping off their hands and feet and by hanging, while Alfonso IX traditionally had thieves hanged, drowned or boiled alive. Yet, all crimes including homicide and rape, could be pardoned, by paying the monarch a specific sum of money called the *calumnia* (also known as calona, coima). O'Callaghan says that this was an important source of income for the kingdom. In comparison, Islamic law was based upon the Koran and the punishment had to be equivalent to the crime. A thief might lose his hand, but any harsher punishment was seen by society as a grave violation of Koranic law. By the same token, a criminal could not legally buy his way out of a crime, particularly in cases involving murder and rape. A Muslim ruler was also expected to consult the men of the law before he offered any judgement.⁵³ But regardless

of whether the Muslims agreed with the Catholic practices or not, even in Muslim-ruled kingdoms the Christians were left to conduct their own affairs as they saw fit, so long as a Muslim was not involved.

The Mozarabs were Catholics who had adopted the social customs of the Moors and Arabs, including the use of the Arabic language. They were very interested in the Moorish culture and were able to partake of it freely, while maintaining their Christian faith. As a result, the Mozarabs have often been depicted by Western scholars as possessing a strong allegiance to Catholicism and its cause. But Vives offers another view of the Mozarabs. He informs us that one of Emperor Charlemagne's major objectives was to annihilate the Moorish frontier by taking Saragossa, which was an important Mozarab redoubt. However, in 778, the Catholic offensive failed because the Mozarabs refused to cooperate with the Catholic Emperor. Vives concedes that the Mozarabs were primarily a "self-absorbed" group.⁵⁴ They understood that they could gain a great deal by remaining in close quarters with the Moors. Like the Jews, the Mozarabs were entitled to their own legal system complete with their own magistrate and own laws. Again, only in cases involving Muslims would a Muslim court have jurisdiction.⁵⁵

One of the most interesting results of Christian Spain's meeting with Moorish Islam was the revival of a theological theory called "Adoptionism." This theory was maintained by Felix, bishop of Urgel, and Elipandus, the metropolitan of Toledo. In attempting to refute the Muslims' criticism of the Christian Trinity, these clerics declared that Christ was adopted by God "the Father" and thereby became the "Son of God." Such assertions were considered heretical by Pope Hadrian I, Charlemagne, and several other Catholic officials.⁵⁶ These Catholic leaders apparently realized that "Adoptionism" was entirely too similar to the Islamic belief held by the Moors: that Jesus "the Christ" was a mortal Prophet, *appointed* for his Divine Mission by the Universal Father-God (Allah). Clearly, the Church could not allow such blasphemous syncretism to exist unchallenged. But, in spite of the accusations of heresy, Felix and Elipandus continued to espouse "Adoptionism" until their deaths in the early years of the ninth century.⁵⁷

Within the first three centuries of Moorish rule, the vast majority of the peasants who had been living south of the Duero river, in the western region of the peninsula, and almost all of the peasants living south of the Pyrennees in the eastern region, had converted to Islam. This phenomenon would prove very significant in the future with the advent of Catholic reconquest and the assimilation of the "Moriscos" (designation for Moors under Catholic domination) into Christian Spain.⁵⁸ By the tenth century, Islam was very much ingrained within the network of this formerly Catholic Hispani-Visigothic society, and Islam became the religion of the majority. Muslims of European as well as Moorish (and Arab) blood, could enjoy the privileges and responsibilities of residing within an Islamic state. *Zakat* (almsgiving) was obliga-

tory and these taxes went towards supporting the state and its social programs. All Muslims in Andalus were required to pay a levy of ten percent to the state on all their capital goods, i.e. animals, merchandise, gold, and silver. Muslims also paid a land tax (*ushr*) of between ten and twenty percent. Jewish and Christian freemen under Muslim rule were required to pay a monthly tributary sum for military protection (*jizya*). But women, children, the physically handicapped, the elderly, slaves, beggars and monks were all tax exempt.⁵⁹ Hospitals (*bimaristan*) were established in the majority of Andalusian cities. They were equipped with baths and running water, and they were divided into various wings for different ailments. The *bimaristans* were open to both Muslims and non-Muslims, twenty four hours a day, regardless of the patients' ability to pay. Drugs and food were always available and the Muslim physicians were knowledgeable in such things as blood circulation, measles, and smallpox.⁶⁰

Moorish society enjoyed such recreations as horse racing, marksmanship, polo, backgammon, chess and musical concerts. Literary salons (*majalis*) were also attended by the learned and the ruling class in general.⁶¹ Public baths were available, and they were open exclusively for women in the morning (men went at noon). In his essay "Baths and Caravanserais in Crusader Valencia," Robert I. Burns informs us: "... for Muslims in general they (the Baths) held an echo of Koranic precepts on washing ... an essential element of social life."⁶² In great contrast with the Moorish regard for bathing and hygiene, was the contempt which most of western Europe had for bathing and physical cleanliness. Burckhardt confirms, like a number of other historians of Andalus, that the contempt which Catholics had for Moorish precepts about bathing, manifested itself in the deliberate destruction of the Moorish baths by Catholic Conquistadores.⁶³ The English historian, Charles H. Haskins, also speaks of the contempt which the vast majority of Catholic Europeans had for bathing, especially on Sunday.⁶⁴ For more information on this matter, I would direct the reader to Terence McLaughlin's historical study: *Dirt: A Social History As Seen Through The Uses and Abuses of Dirt*.

In Andalus, women moved freely in public and engaged in various gatherings. The practice of *pardah* (requirement that women cover their faces in public, etc.) was almost entirely ignored. Moorish Andalus was unique among Islamic nations. It could easily be argued that women enjoyed more societal freedoms in al-Andalus than in any other part of the Islamic world. Even Walladah, the daughter of the twelfth century Caliph al-Mustakfi, had a total disregard for the veil. Walladah also distinguished herself as a famed poet.⁶⁵

The poetry of the Moors had a profound effect upon Christian Spain and all of western Europe. Chejne informs us that the scholarship of Nykl, illustrates "the striking similarities between the *zajal* and Provençal poetry in following important aspects: The rhyme *aaab* in Ibn Quzman's poems and those of the Provençal poets are similar; the Arabic "markaz" or "matla" (estribillo in Sp.)

corresponds to the *finada* or Provençal poems; “the number of strophes, ordinarily five to nine, is a common feature of both Arabic and Provençal compositions.”⁶⁶ The use of a messenger between two lovers, duties of a lover and the general theme also point to a borrowing of Moorish/Arabic composition.⁶⁷ Titus Burckhardt too contends that the very concept of “Chivalric Love” is born of Moorish influences. He informs us that even the famed Alfonso X (“the Wise”) composed his *cantigas* to the Virgin Mary, using the Moorish *zajal* as his model. Burckhardt also points out that:

Moorish culture exercised a strong influence on neighboring Southern France, and the first known (European) poet of courtly love to write in vulgar Latin, Prince William of Aquitaine, is almost certain to have spoken Arabic.⁶⁸

McCabe writes of the abundant gardens of Andalus, and he likens them unto an earthly Paradise.⁶⁹ No doubt this “Paradise” was made even more heavenly by the presence of latrines with running water. This surprising innovation made its appearance in the cities of Muslim Spain sometime before the tenth century, while the rest of western Europe would not know its benefits for several centuries to come.⁷⁰ Andalusian cities even had streets, “paved, lighted (sic), and finely drained by the middle of the tenth century,” writes McCabe.⁷¹ He compares these illustrious Andalusian cities with those of Paris and London some six centuries later. McCabe says of sixteenth century Paris and London: “Foul and contaminated water trickled along, or lay in stagnant pools, on the unpaved streets ...”⁷² Andalusia even had a postal service, and her major roads were dotted with the necessary stables of swift horses.⁷³

The extent, quality and impact of Moorish and Arab influence upon European development can be seen in the words of various European languages which derived from the Arabic. Chejne informs us, “English has many words of common usage—such as coffee, sugar, rice, lemon, syrup, soda, alcohol, alkali, cypher, algebra, arsenal, admiral, alcove, and magazine—which have relevance to human endeavor in the arts and crafts.”⁷⁴ When one remembers that the Islamic empire stretched from Indonesia in the East to the Atlantic in the West (including portions of India, China, Afghanistan, Iran, Russia, and of course much of Africa and the “Holy Land”), it is easy to see how Muslim influences could become so firmly planted within European/“Western” culture.⁷⁵ Sicily was even dominated by Moors and Arabs for over two hundred years, and Crete was ruled by them for one hundred and twenty-five. At its peak, the Muslim empire was even more immense than those of either Alexander the Macedonian (“the Great”) or Rome at its height.⁷⁶ It would only be natural for the culture of the Andalusian Moors to have had a very extensive influence upon western European civilization, as this gifted African/Asiatic society was geographically based on European soil and was readily available to Christian European immigrants.

Agricultural Improvements:

The Moors and other Islamic peoples of Andalus, introduced new kinds of horticultural methods and types of plants, fruits and vegetables, which were virtually unknown outside of Africa and Persia.⁷⁷ From Africa and Asia came rice (“arruz” in Arabic, “arroz” in Span., “riz” in Fr.). It appeared on Spanish river banks in the tenth century according to the records of Arib bin Sa’id, secretary to the ruler al-Hakem II (961–976).⁷⁸ Cotton had been introduced to Iberian soil in the ninth century (*qutn* - Ar., *algodon* - Sp., *coton* - Fr.). On Andalusian soil, the Moors also grew several types of medicinal herbs (i.e. “dardar” or ash trees) from Africa. They were grown abundantly in Spanish regions like: Selba, Elvira, Shulayr (Sierra Nevada) and Guadix. This enterprise was obviously tied to their medical and pharmacological skill and interests. The quality of the herbs was said to rival those grown in India and other Eastern countries.⁷⁹

Andalusian botanists such as Ibn al-Wafid, Ibn Bassal, Ibn al-Hajjaj and Ibn al-Awwan conducted special studies on the productivity and quality of the land. Ibn Bassal partitioned the land into ten different classes according to particular characteristics, and taught farmers ways of increasing the fertility of their plots.⁸⁰ Geological studies were done in order to locate sweet water below the earth’s surface. Wide spread use was made of the water-wheel or “na’urah,” which the Romans knew about but had utilized very little. The Moors dug canals and channels which irrigated farm lands and provided water for several thousand mosques, palaces and public baths.⁸¹ Some of the most highly productive lands were at Saragossa, Merida, Tudela, Murcia (Tudmir), Elvira, Malaga, Lorca, and Baghah.⁸²

Studies of the Iberian soil along with the Moorish introduction of new methods, plants, tools and manures, helped to dramatically increase the fertility of the Iberian land. The astrolabe was even employed by the Moors in leveling the land for easier irrigation.⁸³ But not only did Andalusia’s Muslims increase the productivity of the soil and introduce new vegetation, they also ushered in the science of food preservation and storage. At Saragossa, wheat was preserved for as long as one hundred years. Moorish methods of preservation and drying enabled such fruits as figs, plums, cherries and apples to remain edible for several years. Ibn al-Awwan (12th cent.) was a botanist who wrote in great detail about the process for preserving olive oil, corn and various fruits.⁸⁴

Before turning to the main focus of this essay, it is necessary to say a bit about what I consider to be the two most significant dynasties which entered Andalus. What makes these Dynasties especially significant, is that they were most certainly African, and that they both had a great and positive impact upon the sciences and philosophies of Andalusian society. These two Dynasties, the *Almoravids* and the *Almohades*, left very indelible impressions upon

Spain, and ultimately, western European society and development. O'Callaghan refers to the eleventh century and Almoravid control as the "Golden Age" for al-Andalus. For although the Almoravids (and Almohades) are sometimes regarded as theologically conservative, the intellectual and artistic activity of the country did not depreciate as a result. In fact, the fields of philosophy and science were particularly rejuvenated during the time of these dynasties. In addition, Catholics and Muslims would mix even more freely in such Moorish controlled cities as Toledo, Saragossa, Tortosa and Lisbon. Unfortunately for the Moors, it would also be during this period (11th cent.) that the Hispano-Visigothic Catholics would secure military control over several Moorish cities of erudition, and establish their first center for the translation of Moorish texts at Toledo.⁸⁵

The Almoravids had originated in the deserts of northwest Africa. Wayne Chandler states that ethnic and religious feuds in northern Africa had pushed many "Berbers" deep into the southern desert. There they encountered a more unmixed African people with whom they then intermarried. The fusion of the two peoples produced the Almoravids and their *Mobt-Themin* (wearers of the Veil) who earned a reputation for being fiercely skilled soldiers. The old Moorish work, *Roudh-el-Kartos*, discusses the entry of the Almoravids into Andalus, and it describes the Almoravid leader Yusuf Ibn Tashifin, as a "black"-skinned African. Yusuf had entered al-Andalus upon the request of Seville's Muslim governor Al-Mutammed, in 1086. Yusuf's invading armies consisted of various ethnic groups/"tribes" from western Africa.⁸⁶ After Yusuf and his men entered al-Andalus, it is said that he became angered by the general indolence of the Muslim leadership, and lack of military support given by the presiding Muslim rulers. Yusuf was concerned with the rising military power of the Catholic armies. Consequently, he decided to take control of the country himself, and he appointed his own followers as governors. Yusuf successfully pushed Alfonso VI and his Catholic army out of the Muslim territories that Alfonso had won.⁸⁷

With regard to the earlier discussion concerning Moorish ethnology, it is interesting to point out that a Spanish synonym for Almoravid is *Moabita*,⁸⁸ which again draws our attention to the Biblical people, and the evident phenotypic (and historic?) correlation which the medieval Europeans made between the ancient people of the Bible and the Almoravid Africans. We might also recall another synonym for Almoravid: Murabit or Marabout which phonetically corresponds to Moabite/Moabitarum.

The Almohads assumed control of al-Andalus after a little more than a century of Almoravid domination. Henry Coppee refers to the Almohades as "pure Africans" in contrast to the Almoravids, whose blood was (from Coppee's viewpoint) more mixed with the Arabs.⁸⁹ Like the Almoravids, the Almohades also hailed from the western part of Africa,⁹⁰ an area which includes the peoples of Ghana, Mali, Senegal, and Songhay. O'Callaghan

indicates that the Almohades displayed a particular interest in philosophy. The Almohade rulers encouraged scholarly debates between the Averroist-Aristotelians and more orthodox Islamic theologians such as al-Ghazzali (Algazel, as Europeans called him).⁹¹ French historian Francois L. Ganshof also confirms the considerable love of intellectual pursuits exhibited under Almohade rule. Ganshof says that the Almohades encouraged non-theological pursuits and sought a more secular approach to knowledge. Ganshof writes that under the Almohades there was a greater emphasis upon those "intellectual activities that were not oriented toward theology." He goes on to remind the reader that it was under this dynasty that perhaps the greatest Moorish Andalusian thinkers flourished,⁹² represented by men such as "Averroes" who will be discussed shortly.

Educational Realities & Intellectual Achievement:

Ibn Ghabib, a late ninth century scholar of Moorish Spain, referred to the Andalusians as "good managers, seekers of knowledge, and lovers of wisdom, philosophy, justice and fair play."⁹³ Chejne too comments upon the Andalusian Muslim's high regard for education and knowledge when he states: "Its pursuance and dissemination were conceived to represent the highest attainment in this world and in the Hereafter ... it was tantamount to an article of faith."⁹⁴ Andalusian bookshops were the meeting places for leading scholars and laymen; spirited discussions were conducted on almost every conceivable subject. Chejne continues: "Scholars, rulers, and notables had salons or literary clubs in their homes which were attended by select people. Literary debates pertaining to grammar, lexicography, poetry, religion, law and other topics took place."⁹⁵ Andalus was filled with many schools, known as *madradas*, which taught all of the sciences and philosophies of the period. There were also major Moorish universities such as at Cordova, which was founded in the tenth century by the Caliph *Abd al-Rahman III*. The University of Cordova thereby prompted the emergence of additional schools and universities in other provincial towns such as Seville, Malaga, Valencia and Almeria. Students from far and near attended these institutions.⁹⁶ One contemporary chronicler named Ibne-Idhari, tells of twenty-seven "free schools" of higher education existing in Cordova alone.⁹⁷ The Andalusian Muslim's devout interest in knowledge bore much fruit in the various sciences. The overall mathematical contributions of the Arabic peoples is summarized by B. Carra de Vaux, who said:

The Arabs have really achieved great things in science; they taught the use of ciphers, although they did not invent them, and thus became the founders of the arithmetic of everyday life; they made algebra an exact science and developed it considerably and laid the foundation of analytical geometry; they were indisputably the founders of plane and spherical

trigonometry which, properly speaking, did not exist among the Greeks.⁹⁸

Fortunately for the Christian European, this sort of knowledge which was so common to Moorish Andalus, would eventually make its way throughout Christian European societies.

The Andalusian Muslim resided within a society which espoused the great importance and sanctity of knowledge. Such eminent Islamic scholars as the tenth century belletrist Ibn *Abd* Rabbihi, wrote texts on education and its importance. This Eastern scholar defined education and knowledge as "the pillars upon which rest the axis of religion and the world." He continues:

They [education & knowledge] distinguished man from the beast, and the rational from the irrational being. They are the substance of the intellect, the lantern of the body, the light of the heart, and the pole of the soul ... Indeed the intelligent person who is not taught anything is like not having intellect at all. And if a child were not educated and taught to read and write he would be the most stupid of animals ...⁹⁹

The typical Andalusian's regard for such an outlook as Rabbihi's was quite clear. Imamuddin tells us, "The collection of books was not exclusively a royal hobby, but a passion with the people in general."¹⁰⁰

The Andalusian Moor's great respect for academic pursuits was noted far beyond the physical borders of the country. The technical terms for the astrolabe (an astronomical device invented by the Moors/Arabs) and the names of stars, still retain their Arabic origins even in the West. As we shall see a little later, it was also during the twelfth century, that Europeans would exhibit their greatest interest in Muslim learning. Foreign students from the continents of Asia, Africa and Europe would flood into al-Andalus.¹⁰¹ Western European thinkers such as Adelard of Bath, Plato of Tivoli, Robert of Chester and many others, resided among the Moors, with the intention of learning from them. Catholic Andalusians like Dominicus Gondisalvi and Hugh Santalla, and Jews like Abraham ben Ezra, represent just a few of the countless Europeans who were educated at Islamic institutions in Moorish Spain.¹⁰²

Chejne states that the Eastern countries of Islam (i.e. Egypt, Persia, Arabia & Syria) remained a source of inspiration and even guidance in all endeavors, until about the middle of the eleventh century. [Interestingly, this coincides with the Almoravid arrival]. Andalusian standards had been judged according to their comparison with those of the East. Consequently, the Andalusian Moors sought to exceed the standards of their Eastern counterparts in all areas, and at times Andalusian professionals and artisans lamented over the belief that they were still not receiving proper recognition for their achievements, simply because of their western location. A kind of professional arrogance existed among Easterners as they flaunted the fact that they were residents of the lands which had produced some of the important Andalusian

skills and sciences.¹⁰³ But Andalusian scientists greatly improved upon what they had acquired. "From Asia Minor, Greece, and Egypt," writes Paul Lacroix, "the exact sciences passed to the Arab schools of Spain at Cordova, Seville, and Granada, where they were cultivated with much success."¹⁰⁴ Aside from recognizing that Lacroix's reference to "Arab schools" does not exclude Africans/Moors, since Andalus was dominated by Africans ("Berber"/Moorish) in ancestry, we should point out that most of the alleged philosophy and erudition of Greece, is increasingly being established as having actually been Kemetic (Egyptian) in origin. Therefore, the presence of so-called "Greek knowledge" in Moorish academia, is, in reality, largely erroneous or overstated. We will address this issue later.

Jose M. Millas Vallicrosa is a Spanish historian who has shed considerable light upon the great significance of the Moors to Christian Spain and western Europe as a whole. Vallicrosa, who made considerable use of primary Spanish sources, has earned a reputation in the field of intellectual history as it relates to al-Andalus. Vallicrosa makes the point that in 529 A.D. there was a migration of Greek scholars to Persia. These individuals were fleeing the tyranny of the Emperor Justinian, who had closed the academy at Athens and began persecuting the Greek teachers. Persian rulers welcomed these learned refugees and Baghdad soon became the new center for the sciences as these scholarly refugees carried their ancient wisdom into Persian society.¹⁰⁵ Chejne says that the tradition of supporting the sciences continued in Persia. Consequently, additional waves of Hellenic scholars continued to flee Byzantine Greece for Persia and elsewhere. Even after the coming of Islam to Persia during the 7th century, these Greeks were still able to flourish within the new Islamic state. Abbasid Caliphs such as al-Mansur (754-775) and al-Ma'mun (813-33), encouraged the translation of ancient Greek manuscripts. Such support for the ancient writings and teachings continued under Persia's Islamic rulers.¹⁰⁶

Vallicrosa mentions Harun al-Rasi (786-809) and his successor al-Mamun (813-833) as the two caliphs who most revered and supported academic pursuits in Abbasid controlled Persia & the so-called "Middle East." In assessing what the Muslim world did with their ancient Greek transmissions, Vallicrosa writes of the cultural syncretism that occurred, as Moors and Arabs of the Islamic world appropriated the ancient wisdom:

In the full fever of the translation of the Greek, those Eastern sciences: astronomy, mathematics, astrology, were syncretized with the Greek, as we can see in the works of al-Jwarizmi. And the Muslims who were in possession of all the elements of the previous cultures worked now on their own, correcting and surpassing the Greeks and Indians, checking the Tables of Ptolemy, perfecting their Geography, creating a technique and an instrument of experimentation which was incomparably superior to that of the Greeks, and in short, elevated the culture to a degree of apogee that constitutes one of the most illustrious moments of humanity.¹⁰⁷

Hastings Rashdall addresses the various ways in which western Europe received the knowledge of the ancients. On the acquisition of Aristotle-attributed texts he states:

By the beginning of the thirteenth century, in consequence of the opening up of communications with the East — *through intercourse with the Moors in Spain*, [emphasis mine] through the conquest of Constantinople, through the Crusades, through the travels of enterprising scholars — the whole of the works of Aristotle were gradually making their way into the Western world. Some became known in translations direct from the Greek: more in Latin versions of older Syriac or Arabic translations.¹⁰⁸

As we continue, we will acquire a better sense of the great number of ancient and contemporary writings which came to Europe through the Moors of Andalus.

While it may be true that the Moors of Andalus may have acquired some uniquely Greek knowledge through the support of the Abbasid (the ruling dynasty of Baghdad) for the Greek immigrant-savants, there is also evidence which suggests that the Moors already possessed most of what the majority of European historians say they allegedly acquired from the Greeks.

The Andalusians were enjoying the full flower of their civilization nearly two hundred years before the western based Catholic armies had conquered and ransacked the city of their own fellow Christians of Byzantium, during the 13th century. It also stands to reason that the reputation of Moorish Spain and the openness of her society, would have attracted students from all over Europe. After all, western Europe had much easier access to al-Andalus than to any other part of the eastern world, including Byzantine Greece. It would make much more sense therefore for the bulk of Greek and Islamic scholarship to have entered into western Europe via Moorish Andalus, and few intellectual historians today would or could dispute this fact.

Although a few Islamic rulers were annoyed by certain ideologies which surfaced in al-Andalus, the society remained a stronghold of science and philosophy. Few, if any, Andalusians were ever forced to flee the country in fear for their lives, because of their scientific or philosophical views. Yet, it was rather common for learned Greeks to flee Christian Byzantium, in order to escape persecution and even death. Given these facts, how indigenous could secular knowledge be to a society which was so often violently opposed to it? Equally relevant is the fact that the pre-Christian Greeks of antiquity were also known to have endured similar censorship! Consequently, if we are to believe that natural science and Aristotelian philosophy were the products of native Greeks, and if we are to accept that it was a definite part of their indigenous society, then why were the ancient Greek scholars so often persecuted? There are some historians who have asked this same question and thereby concluded that "Greek Philosophy" is actually a misnomer. Such

scholars contend that it is little more than the continuation of ancient Egyptian teachings, created by Egypt's own African priests.

The late great intellectual historian George A. James, wrote something which is very profound in relation to the ancient Kemites (Egyptians) and the "medieval" Moors. He stated:

... the people of North Africa were the neighbours of the Egyptians, and became *the custodians of Egyptian culture* [emphasis mine], which they spread through considerable portions of Africa, Asia Minor and Europe. During their occupation of Spain, the Moors (Mauretians) displayed with considerable credit, the grandeur of African culture and civilization.¹⁰⁹

James also elaborates upon what Vallicrosa had alluded to earlier concerning the Byzantine Emperor Justinian. James states that both the edicts of Theodosius in the fourth century and later of Justinian (529), closed down the temples of the "Egyptian Mysteries" as well as the philosophical schools of Greece. The result was an intellectual darkness which descended over civilized Christian Europe and the entire Graeco-Roman world. It lasted for nearly seven centuries and the Greeks were afforded no open opportunity to improve upon the ancient Egyptian knowledge.¹¹⁰

James points out that the ancient Greeks had traditionally migrated to Egypt for the purpose of education, and they had been doing this ever since the Persian invasion in 525 B.C. By citing ancient sources, histories by Pliny, Hermodorus, Strabo, and Plutarch, James sought to establish that the wisdom of the Hellenic thinkers was an import from Egypt. James reminds us of ancient Greece's habitual expulsion of her resident scholars. Anaxagoras was indicted and imprisoned by the Greek authorities, and he had to escape back home to Ionia. Plato and Aristotle were forced to flee Athens under great suspicion, and of course the fate of Socrates is well known to students of European Classics.¹¹¹ James seeks to establish that these men were not the standard teachers among Greeks and had not been schooled with an indigenous Greek education. James contends that these men were harassed and punished by the government of the Greek city-state, for introducing foreign and dangerous doctrines. In addition, James points to the highly impractical practice within "Western" academe, of attributing the authorship of as many as one thousand different books on various subjects, to Aristotle.¹¹²

James believes that the Royal Egyptian library was immediately ransacked and looted by the Greeks upon the arrival of Alexander's armies.

Just as these books were captured in Egypt by the army of Alexander and fell into the hands of Aristotle, so after Aristotle's death, these very books were destined to be captured by a Roman army and conveyed to Rome

...¹¹³

Hence, we see another primary path by which Europeans acquired ancient

African knowledge. I might also direct the reader towards the recent work *Black Athena* (1987) by Martin Bernal, which also establishes the African origins of so-called Greek Philosophy.

If we consider the evidence of James, it would appear that if the Moors had borrowed anything from the Greeks, it was in many cases something which the African had already possessed. James maintains:

During the Persian, Greek and Roman invasions, large numbers of Egyptians fled not only to the desert and mountain regions, but also to the adjacent lands in Africa, Arabia and Asia Minor, where they lived, and secretly developed the teachings which belonged to their mystery system. In the eighth century A.D. the Moors, i.e., natives of Mauretania in North Africa, invaded Spain and took with them, the Egyptian culture which they had preserved. Knowledge in the ancient days was centralized, i.e., it belonged to a common parent and system, i.e., the *Wisdom System* or *Mysteries of Egypt*, which the Greeks used to call *Sophia*.¹¹⁴

Aside from comparable expertise in medicine and other areas of natural science which both the "medieval" Moors and ancient Kemites shared, I can also see a peculiar similarity in architectural skill. Dr. Ivan Van Sertima pointed out that at Lixus, Morocco and Gizeh in Egypt, there are the "finest African examples" of "fitted megalithic masonry."¹¹⁵ We are told that the technique requires great skill, as the massive stone blocks which are fitted together are not of any one shape or size. Van Sertima says that the stones in these structures display "the complex regularity of patterns or designs in a jigsaw puzzle."¹¹⁶ I find this to be a curious correlation between Morocco's Maures/Moors and Egypt's ancient Kemites, and I would relate this to observations and assertions of George James, regarding the Moors being "custodians" of ancient Egyptian erudition and culture.

While many European/"western" academicians have regarded contentions such as those of James as far-fetched, it is easy to see how one might question the credibility of "the Greek miracle" after noting the prevailing tendency among Western scholars to eliminate all discussion of the Egyptian middlemen. This is rank racial chauvinism in light of all the evidence of historical contact between the Greeks and Egyptians. It serves to perpetuate ignorance of the facts among continuing generations of students and scholars.

I would also add that, for a people who were allegedly so far in advance intellectually and technologically, it is peculiar that the Major Center for science/technology in the ancient world was not in Greece, but in Egypt. One should always bear these things in mind as one reads of Moorish texts on Aristotle, Plato and other Greeks, and the Western assertion that the Moors merely acquired ancient European (i.e. Greek) knowledge.

Areas of Expertise Among Andalusian Moors

In assessing the general attitude among all Muslims of the "medieval" period, Fazlur Rahman tells us that physicians (*hakims* in Arabic) were considered the most vital of scientists and of greater importance than philosophers. The physician was the life-saver, and because of the direct life-saving application of medical sciences "Muslims had bestowed on the art of healing exceptionally high religious value and priority."¹¹⁷ Appropriately, in the field of medical science the Andalusian Moors made remarkable progress and surpassed the Greek-trained Muslim physicians of Persia (Nestorians) and other Eastern Islamic nations.¹¹⁸ Moorish medicine was based upon experimentation (*tajribah*), reasoning (*qiyas*) and observation. Moorish physicians used drugs, surgery, and cauterization; medicine was a highly technical profession complete with extensive training and a code of conduct. Physicians were academically trained scholars whose conduct and code prescribed stateliness, kindness, unselfishness, understanding, and discretion. The physician's hair and nails had to be short and their bodies were always to be clean. They also wore white attire. Each physician had to pass a licensing exam before beginning his practice.¹¹⁹ In the meantime, Chejne informs us of how western European healing practices at that time still largely relied upon charms and amulets; socially and politically powerful clergy frowned upon and repressed medicine, thereby leaving the field in the hands of quacks and barbers.¹²⁰ Perhaps the most common form of therapy among the medieval European was that of covering the sick with blood-sucking leeches in order to draw out illness.

Europeans offered no competition with Moorish advances in pathology, aetiology (study of diseases), therapeutics, surgery and pharmacology. Texts were written by Moorish physicians describing surgical technique and the instruments that were used; doctors specialized in pediatrics, obstetrics, ophthalmology, and in the treatment of hernias and tumors. Imamuddin tells us that Moorish scientists were even importing monkey skeletons from Africa for use in dissection when conditions prevented the use of cadavers.¹²¹

For the Andalusian Moor, scholarly endeavor was considered divine. The more one knew of one's self and one's World, the more one was supposed to know of one's Creator.¹²² The ancient Kemetic creed "Know Thyself" was very much the creed of Andalus. From the commoner to the Caliph, this was the primary philosophy of the Andalusian Muslim. Rulers such as the Caliph *Abd al-Rahman III*, spent almost one third of the state's income on education.¹²³ At a time when most Christian monarchs could not even write their own names, the Caliphs (*Khalifs*) of Moorish Spain were often scholars. The Caliph *al-Hakim II* (960-90?) had a personal library of almost half a million books, and he was said to have been familiar with much of it.¹²⁴ Interestingly, McCabe points out how even after Europe had inherited Moorish and Arab

academic gifts, she did very little with them at first; eighty-five percent of Europe would still be illiterate in the eighteenth century. McCabe states that significantly more than fifty percent of Andalusians could read over seven hundred years earlier.¹²⁵ When we consider the huge number of bookshops/dealers in Cordova alone (20,000)¹²⁶ McCabe's seemingly high estimates on Andalusian literacy are given support.

When one evaluates the general status of Europe during most of its medieval period—and even the centuries which followed, one has to ask: What happened to all the scholarship and wonderful cultural acquisitions from Africa and the East? It would appear that the Catholic powers only took an interest in Eastern/Oriental knowledge and science, in order to compete politically and socially with the Moors and other Muslims; and when the Moorish Islamic threat diminished, so did Catholic Europe's interest. Monroe believes that this was certainly true of Catholic Spain.

Monroe asserts that the basis for setting up centers for Arabic studies was an attempt by Catholic powers to counter Islamic expansion.

Faced with a foe superior in culture, the Spaniards of medieval times were quick to find means to combat an alien and invading civilization by studying its nature and then writing a polemical literature destined at first to halt the Islamic expansion and later to convert the Moriscos of Granada to Christianity.¹²⁷

I might add that the fruits of these studies by the Spanish Catholics ultimately made their way into other European nations. With regard to the attempts at conversion through the use of theological argumentative literature (polemics), success is not clearly evident, particularly when one recalls the establishment of the brutally coercive "Inquisition," and the tendency of the Moors to flee Catholic-controlled regions.

Some medievalists, like Rashdall, frequently claimed that the primary reason for Catholic Europe's interest in the translation and study of Moorish treatises, was for the purpose of converting the Moors into Catholics. But, as we take note of the type of work which was being translated, we see that much of Europe's focus was upon Arabic/Moorish scientific and mathematical texts. This fact does not offer much support for the assertion that the primary interest of Catholic-dominated European societies was simply the proselytizing of Muslims.

Naturally, countries throughout the world heard of the greatness of Moorish Andalus' civilization. Foreigners knew of the hospitals (bimaristans) which were open to all, regardless of one's ability to pay, and the illustrious colleges or madrasas.¹²⁸ One example of the type of curriculum of Andalus can be seen in the educational prescription of Ibn Hazm (994–1064). Hazm was a Cordovan-born Muslim who had established close ties with the ruler *Abd al-Rahman V* of Cordova. Hazm had written a text on the psychology of the legal

profession and the importance of education. He took his role as an educator very seriously, and he declared that it was greedier to withhold knowledge from the curious, than it was to withhold material possessions.¹²⁹ Hazm contended that a person's formal education—learning to read and write—should begin at five years old. The curriculum of this Moorish scholar from the tenth century, advised the following:

- 1) The study of the Holy Koran, followed by an evaluation of its meaning.
- 2) Addition, Subtraction, Multiplication, Division, Fractions and Plane Geometry (in that order).
- 3) Arithmetic
- 4) Euclid's treatise on "celestial bodies."
- 5) Ptolemy's *Almagest* (this should be studied in order to understand the concepts of duration, limitation, etc.)
- 6) Logic
- 7) Botany, Zoology, Geology and Medicine (in that order)
- 8) History—emphasizing the causes for ascension and decline in ancient society with the intention of avoiding repeated errors.
- 9) Religious Law (*Shari'ah*).¹³⁰

Perhaps it is needless to say that there are several parallels with our own "Western"/modern curricula. Amazingly however, this curriculum existed among the Moors almost a thousand years ago. Chejne goes on to tell us that Hazm called for "a general and integrated education in all the sciences" and he recognized the "interdependence of the disciplines."¹³¹

One can easily recognize the historical foundation and prototype for Europe's concept of the "Renaissance Man," in the societal reality and educational philosophy of the medieval Moors. Hazm even professed that a knowledge of the Koran was "not sufficient without a knowledge of Prophetic Traditions and related disciplines and without the knowledge of language, medicine and other disciplines."¹³² In truth, most of the disciplines studied by Moorish students usually required an understanding of various other disciplines. The Sciences were approached Holistically. For example, physics encompassed medicine while arithmetic included calculation as well as inheritance laws and business.¹³³ Consequently, Europeans from the scientifically emaciated countries of the Christian West made their way into Moorish Spain, either to behold the country's wonders or to partake of such social and intellectual advantages.

Most of the erudition of Andalus rested within her urban centers, and as Joseph McCabe states, "Christian visitors to Moorish cities took away thrilling stories of their splendour and learning." Even a nun in a remote cloister in Saxony (northwest Germany) knew of the magnificent Moorish cities in Andalus. The nun, Hrotsvitha of Gandersheim, called the Andalusian cities "the world's ornament."¹³⁴ The Moorish city of Cordova, which is often regarded as the medieval world's most cosmopolitan and sophisticated city,

possessed (in the tenth century) 1600 mosques, 900 public baths, 213,077 middle class homes, 60,300 mansions, and 80,455 shops. Wealthier homes consisted of two floors, a library, gardens and running water. Her population was estimated between half a million to one million residents. All of these figures come to us from the seventeenth century scholar of the Maghrib, al-Makkari, who consulted the medieval Arabic records.¹³⁵

Anwar Chejne tells us that the Andalusian Moors (and Arabs) “produced in the Arabic language a great literature, covering every subject known in medieval times: religious studies, language, history, belles lettres, geography, medicine, mathematics, astronomy, philosophy ... poetry.”¹³⁶ The cities of Cordova and Seville were internationally known for their beauty, scholarship and culture. Cordova is said to have had some 20,000 bookstores and the Pakistani historian, S.S. Ahmad, tells us that books were very inexpensive, largely due to the principles of “supply and demand.” Simply put, the large number of bookshops required a lower cost in order to attract business. The country’s larger urban centers possessed latrines by the tenth century, complete with running water. This is six centuries before any other European region.¹³⁷ Andalus also had by the tenth century a postal system of swift horses and lighted streets.¹³⁸

The Moors had introduced to Europe more effective irrigation systems, various fruits, and horticultural methods which were virtually unknown outside of Africa. Until their decline around the 14th century, the Moors were the backbone of leather, metal and wood-working, as well as the pottery, silk, and wool-weaving industries. The Moors had even set up municipal regulations for the various trades.¹³⁹ In reference to their architecture, McCabe states that the Moors, “carried the standard of internal decoration of houses and palaces to a height unknown elsewhere in the world.”¹⁴⁰ In contrast, medieval Christian Europe was steeped in the squalor and bleakness of scientific and cultural ignorance. The castle or abode of the medieval European was most often dank and cold, with the floor covered in animal and human droppings.¹⁴¹ It is only after the coming of the Moors (and other Muslim peoples) to western Europe, that Christian Europe begins to resemble an industrious Civilization – in the true sense of the word.

Andalus’ reputation spread far and wide. Many Europeans from outside of the Iberian peninsula began crossing the borders in order to study the wonders of a highly civilized people and their society. Moorish schools and bookshops were open to all those who entered the land peacefully. As a result, the erudition of men such as Abu Walid Ibn Mohammed Ibn Rushd, Abu Bakr Ibn Bajjah, Ibn Sina, Abulcasis and others, became increasingly popular in Western circles of academia, particularly among Clerics.

Abu Walid Ibn Mohammed Ibn Rushd, known to most Europeans as “Averroes,” was born to a distinguished Cordovan family in 1126. Although he distinguished himself as a physician and mathematician, Ibn Rushd spent

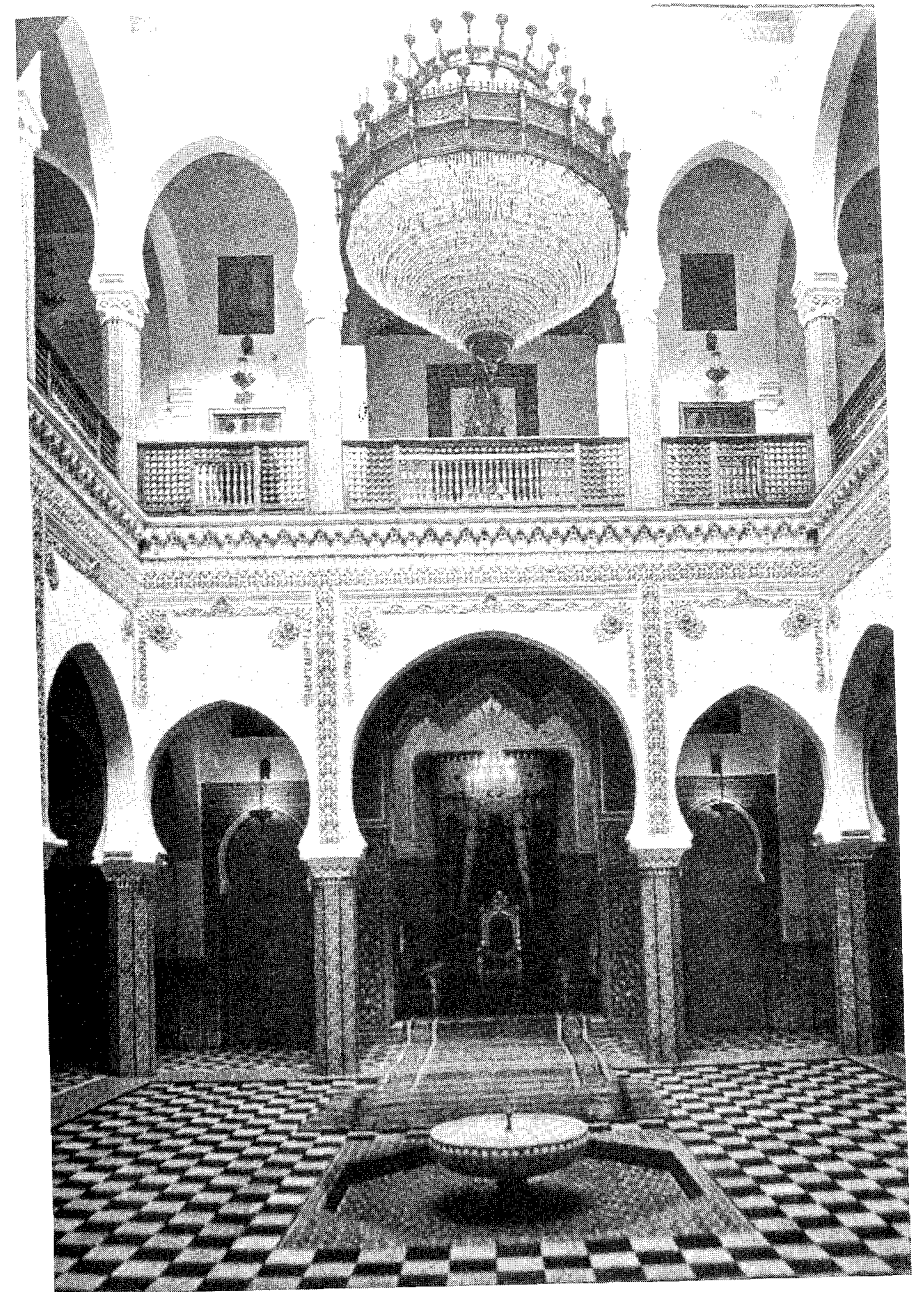

Figure 4. A Palace in Tetouan, Morocco, showing the great beauty and ornate complexity of Moorish architecture. [Tour book]

much of his life studying those ancient philosophical writings whose authorship is commonly attributed to Aristotle. Averroes sought to illustrate the harmonious relationship which existed between religion and ancient philosophy.¹⁴² Perhaps his most dominant influence was upon the Catholic Church's scholastic dogma,¹⁴³ and as we shall see later, his greatest individual impact can be noted in the works of the prominent Catholic thinker, Thomas Aquinas. Also a physician, Averroes' encyclopedic medical text: *Al-Kullyat fi-al-Tib (Generalities On Medicine)*, earned him the credit for being the first physician to recognize that smallpox could only be contracted once. The text described and illustrated with highly detailed drawings, the function of the retina of the eye.¹⁴⁴ It also discussed various diseases and their symptoms, pharmacology, physiology, anatomy and personal hygiene.¹⁴⁵ In 1255 the text was translated into Latin under the title of *Colliget*.¹⁴⁶ Also known as *Correctorium*, the mastery of this text was required for a medical degree at Bologna.¹⁴⁷

Another renowned Moorish savant was Abu Bakr Ibn Bajjah ("Avempace"). Born in Saragossa in 1085, Avempace was highly influential in medicine, philosophy and mathematics. Before his death in 1138, he had written on all the disciplines just cited, as well as on music.¹⁴⁸ His book *Solitary Regime* was an international classic and his philosophical writings were translated into several European languages, and promptly initiated several scholarly debates throughout Europe.¹⁴⁹

Ibn Sina (980–1037), also known as "Avicenna," was a forerunner to both Avempace and Averroes. A true "Renaissance Man," Avicenna was a renowned physician who had also mastered Logic by the age of fourteen; he is also responsible for codifying many Greek-attributed philosophical systems.¹⁵⁰ During the early 14th century, Avicenna's medical writings, under the titles of *Primus Canonis* and *Quartus Canonis*, became two of the standard texts for licensing physicians at Montpellier's medical school.¹⁵¹ At Bologna, the mastery of his medical text "Canon," was required for licensing.¹⁵² In the field of Geology, Avicenna performed studies on the crust subsistence of the Earth at various eras in its history, and the stratification of rocks. He also classified many of the Earth's minerals.¹⁵³ Several of his writings were translated by Europeans and used extensively at Western universities.

The Catholic European's interest in Moorish erudition apparently existed almost from the very beginning of Moorish control of Iberia. Vallicrosa discovered original 10th century manuscripts of Arabic texts in the Catholic monastery of Santa Maria (in Ripoll). These Arabic treatises covered such topics as mathematics, logic, astronomy and medicine. The existence of these Arabic treatises reveals Catholic Europe's early interest in the study of Moorish scholarship—in spite of the fact that the Muslim authors were customarily maligned as heathens. *Corpus*, a Latin text, was a collection of Moorish writings on natural science, astronomy, computation, and geometry. It had been compiled at Ripoll.¹⁵⁴ Knowing this fact, we can certainly hy-

pothesize that there were several other monastic European centers of the same early period, involved in the translation and study of Moorish works. What is ironic, is that the Catholic hierarchy publicly denounced such works as "diabolical," and often referred to the Moorish schools as schools of "demonology." Colin Smith reveals such hypocrisy among Catholic officials:

It was normal for Christian authorities to condemn astrology and its implications, while often being learned in it themselves. Much important material, both scientific and pseudo-scientific, was translated from Arabic into Latin, and later from Arabic into Castilian, in the 12th and 13th centuries at Toledo, Seville, etc. At first under Church patronage, later under royal aegis.¹⁵⁵

One tenth century Christian Count critically recalls how the Moors were "guided by the stars" and "not by God." Yet, astrology was one of the areas in which European academicians & Church patrons were most interested. As Smith's medieval Latin text reveals, the Count also spoke of how the Moors knew many spells and charms which could "stir up the clouds and winds."¹⁵⁶

I think it is significant just to note here, that the tenth century Latin reference that is used, is "moros" and not "alarave" or "Arabes" (Arab).¹⁵⁷ I think that the reader may also be interested in the emotional tone of the Catholic Count who authored this passage, as I certainly considered it to be rather strange. For even as the Count criticizes the Moors for what he obviously perceived as their sacrilegious or paganistic vision of stellar movement, the Count himself reprimands his own God for not assisting him in a battle against the Moors.

"True Christ," cries the Count "you have not kept your part of the bargain as it was stated to me. You made a pact with me ..." ¹⁵⁸ It seems rather peculiar for a "reverent" Catholic of this era to address his Supreme Lord, Jesus, in such a manner.

When we consider the political and socio-spiritual threat which the Moors posed to Catholic Europe, it is not hard to understand the respect and/or envy which many Europeans had for the Moorish culture and learning. While many Catholics resisted the cultural intrusion of the Moors, several Europeans mimicked Moorish customs and manners. Even the 11th century Spanish Catholic king Alfonso VI dressed in Moorish attire, and had five wives (one of whom was a Moor: Zubaydah, daughter of Seville's Moorish ruler, Mu'tamid).¹⁵⁹ There was even an entire socio-political group born of European interest in Moorish culture. The Mozarabs, as I mentioned earlier, were Catholic Iberians (Spanish) who had adopted many of the customs of the African Islamic peoples, including their Arabic language. These Arabic speaking Catholics proved to be very significant in the transference of Moorish culture to Christian Europe.¹⁶⁰

Even as Moorish political and military power began to wane in Andalus,

Europeans maintained their interest in Moorish scholarship. Catholic rulers set out to translate Arabic texts. Perhaps the best known Christian European patron of translation was Alfonso X ("the Wise"). Alfonso X supported a "school" of translators at Toledo during the 13th century, and although we know that the translation of Moorish treatises had been going on at least as early as the 10th century, Toledo became the major center of translation for Christian Europe. Because of Alfonso's great support and financial backing, Toledo became more productive in the 13th century, than other centers of translation throughout Europe, such as those at Barcelona, Tarazona, Leon, Segovia, Pamplona, Toulouse, Beziers, Narbonne and Marseilles.¹⁶¹

Alfonso was truly "Wise" for engaging in such an enterprise as translating and studying Moorish scholarship. Alfonso amassed at his Toledan "school" translator-scholars from England, Italy, France and several other European lands. These men translated scientific, didactic (morally instructive), polemical, and recreational treatises from the Arabic into Latin,¹⁶² into the developing Spanish vernacular as well as other European languages, like French.¹⁶³ The works of Andalusian scientists like Abdul Rahman bin Ishaque bin al-Haisham, who had written a text on ophthalmology which outlined the effects of twilight upon the eye, was translated (*Ilmul-Basr-wa-al-noor* (Ophthalmology)) and spread throughout the academic institutions of Europe.¹⁶⁴ Abu al-Qasim Khalif Ibn Abbas al-Zahrawi (936?-1013), also known as "Abulcasis," was a renowned Muslim physician and court doctor to the Andalusian Caliph al-Hakam II.¹⁶⁵ Abulcasis wrote an encyclopedia of medicine and surgery entitled *al-Tasrif*. In this three-volume work were sections on cauterization, surgery (including detailed discussions on the destruction of kidney stones, as well as ophthalmic and dental surgical procedure), and a section on treating fractures.¹⁶⁶ One of Alfonso's translators, an Italian named Gerard of Cremona, translated the text into Latin and *it became the standard text for the instruction of European surgeons*.¹⁶⁷ New editions of the work were still being published and utilized centuries later at Venice in 1497, Basel in 1541, and Oxford in 1778. The famous medical schools at Montpellier (France) and Salerno (Italy) used the text for training physicians, complete with its superb illustrations on the destruction of kidney and bladder stones and the surgical instruments which were to be used.¹⁶⁸ Another of al-Zahrawi's works, discussed the preparation of drugs using plants, animal derivatives and mineral compounds. European scholars translated this into Latin as: *Liber Servitoris*.¹⁶⁹

Abu Marwan Ibn Zuhr (known by Europeans as "Avenzoar") was Averroes' medical teacher, and this twelfth century Sevillian-born Moor conducted original research in therapeutics, tumors and abscesses, while serving as a court physician to both the Almoravid and Almohad courts. His work *Kitab al-Taysir* discussed nutrition and pharmacology.¹⁷⁰ It was translated into several

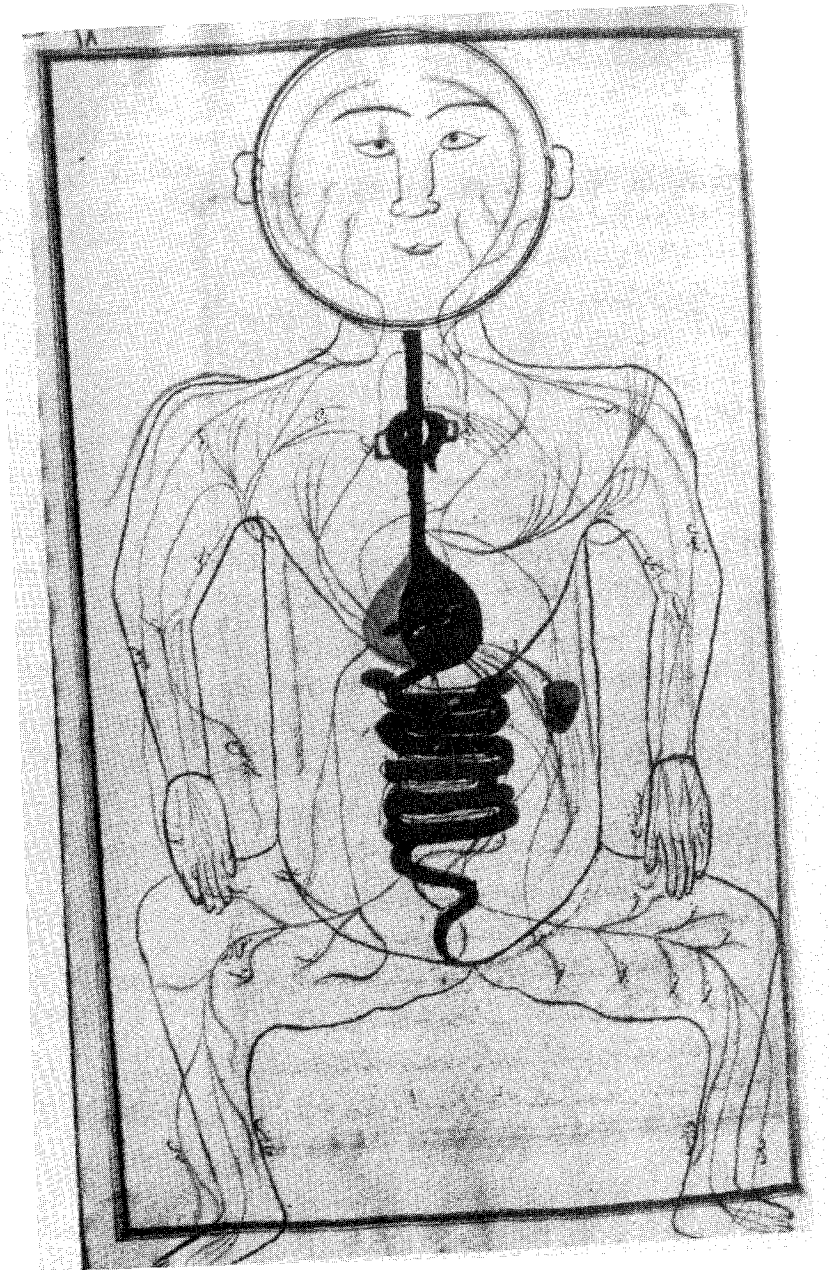

Figure 5. An anatomical illustration of the human body from a 19th century Muslim medical text. [From Tashri-i-mansuri in the University Central Library, Tehran]

European languages. An Italian (?) translator named Paravicinus translated it into Latin in 1280, under the Latin title of *Thesir*. Another of Avenzoar's famous texts was a medical work entitled *Iqtisad*.¹⁷¹

The civilized world recognized the scientific brilliance of the Andalusian Moors, and many western Europeans also came to recognize and utilize Moorish thought. Medieval Europeans were introduced to the assertions of Moors like Ibn Khatib, a physician who declared that "The Plague" or "Black Death," was caused by tiny unseen contagions. In a treatise Khatib said:

The fact of infection becomes clear to this investigator who notices how he who establishes contact with the afflicted gets the disease, ... transmitting is effected through garments, vessels, and earrings.¹⁷²

Another Andalusian Moor, Ibn Khatimah (d.1369), espoused the same contagion theory. Yet, the masses of Catholic western Europe remained ignorant; they simply perceived the plague as the direct hand of God.¹⁷³ To my knowledge, no medieval European histories reveal a pre-Moorish theory of contagion. As far as is known, medieval Europeans offered no scientific reasons for "infection." Let us again remember that the Catholic masses did not view bathing and personal hygiene as vitally important to good health and the prevention of disease.

The medical knowledge of Moorish Andalus was shared with all those who sought it. Lectures on medicine were presented by the country's most famous physicians/medical scientists at various universities in al-Andalus. The students who attended them and completed all the coursework were issued a diploma (ijazah). As a result, many non-Muslim students (foreign and domestic) acquired the expertise of their Moorish Professors. Imamuddin tells us further that "Jewish physicians acquired the knowledge of Arab[Moorish] science and grew famous everywhere."¹⁷⁴ Al-Andalus enjoyed international honors for her gifted instructors and the excellent physicians she produced. Even today in Sri Lanka, the Gopola family, descendants of a famed Moorish doctor, Abu Bakr Mohammed Ibn Abdel Malik Ibn Thufail al Madani, proudly trace their ancestry back to this Andalusian physician. Born in 1165 at Wadiash (a township of East Granada), al Madani graduated from the University of Cordova and became Chief Physician, Counsellor, and Secretary to Caliph Abu Yakub Ibn Yusuf of Morocco.¹⁷⁵

Chemistry treatises by the 12th century Andalusian-Moor Jabir were studied by Europeans in academic circles. Jabir was a well known chemist, known for his discovery of nitric, sulphuric, and nitro-muriatic acids. Moorish chemists, in general, had also been sublimating, calcinating and distilling several centuries before western Europe's *alchemists*.¹⁷⁶ Incidentally, the word alchemy appears to indicate an African origin, as *chem* is a reference to Egypt, and *al* is a common term of introduction for "a subject" in the languages of Arabic and Spanish (Al-Andalus for example).

Despite religious differences, Europeans clearly had easy access to Moorish scholarship. In fact, Andalusian social realities of religious tolerance encouraged Christian European accessibility. In assessing the Muslim world in general, Benjamin Lewis had this to say: "While great numbers of Jews and dissenting Christians of various kinds fled from Christendom to the lands of Islam there were very few who cared to move in the opposite direction."¹⁷⁷ But the great advantage which many Catholics/Christians took, appears to have concerned some Muslim contemporaries. At least one Andalusian Muslim was known to complain about the considerable ease with which Christian Europeans were able to acquire and commandeer Moorish scholarship. In his work: *Seville Musulmane*, Ibn Abdun (12th cent) wrote: "Books of science ought not to be sold to Jews or Christians, except those that treat of their own religion. Indeed, they translate books of science and attribute authorship to their co-religionists or to their bishops, when they are the work of Muslims."¹⁷⁸

Although he was a Catholic, King Alfonso X (coronated in 1252) eagerly patronized the translation of scientific, recreational, and philosophical texts, which had been written by African, Arab, and Persian Muslims. Under Alfonso's patronage, the organized "school" of translators produced more translations than any other European center. Alfonso was undoubtedly "Wise," for he was able to deviate from Church dogma and turn his Catholic subjects on to Moorish erudition. He recognized the usefulness of Moorish scholarship, in uplifting the comparatively "backward" nations of Catholic Europe. But let us be mindful that Alfonso was not the first to establish such an organized center of study and translation. In fact, Alfonso X was only continuing a "school" of translators which had been established almost a century earlier by Archbishop Raimundo of Toledo, who was actually a French national (Raimont de Sauvetat 1125-1152) who had settled in Andalus. Raimundo had established this scholarly center for the good of Christian/Catholic Europe's intellectual progress.¹⁷⁹ There was also a co-founder with Raimundo, a Bishop named Michael. These two clerics had created an international community of translators at Toledo.¹⁸⁰ They served as patrons to such European savants as Peter "the Venerable" and Plato "of Tivoli."¹⁸¹ Plato, an Italian, translated Moorish treatises on mathematics and biology. Plato's famed translation, *Liber embadorum*, was translated on August 15, 1145. The text discussed Trigonometry as well as the biological processes of menstruation, something which was completely foreign to the scientifically starved mind of the western European.¹⁸²

Proctor informs us that more than just translation was going on at these Toledan centers. She cites a 13th century European, Geoffrey of Vinsauf, who spoke of Toledo as a center for the study of the Moorish/Arabic sciences: arithmetic, geometry, astronomy, and music, otherwise known by the Latin-

European academy as the *quadrivium*. Geoffrey placed the city's academic significance alongside those of the cities of Bologna, Salerno and Paris.¹⁸³ What was common among all these European cities was the extensive use by their academies of Moorish and other Muslim scientific treatises. Throughout the medieval period several European translator-scholars would sojourn from al-Andalusian cities such as Toledo, with stores of precious Moorish manuscripts.

Of all the translators at Toledo, the best known is probably Michael Scot. A Scotsman by nationality, Scot came to Toledo about forty years before the reign of Alfonso. Charles H. Haskins tells us that his early education is a mystery, but by 1217, he is credited with the translation of a Moorish astronomical and mathematical text. Scot's translation of the writings of the Moorish scientist, al-Bitruji, appeared as *Alpetragius "On the Sphere"* on August 18, 1217.¹⁸⁴ This European translator ultimately acquired a reputation as a brilliant scholar, as a result of his great familiarity with the works of Moorish and Arab scholars. Even Scot's original works *Liber introductorius* and *Liber particularis*, merely cite the scientific observations of African scientists like Albumacer, Jafar, Zael, Mashallah, and a number of other Andalusian thinkers.¹⁸⁵

Michael Scot's major emphasis tended to be upon the writings of the Cordovan born Moor, Abu Walid Ibn Rushd (Averroes). Averroes' commentaries (evaluative assessments) on Aristotelian-attributed texts, were of primary interest to Scot and his clerical patrons. Vallicrosa informs us that Scot's translations of Averroes' works were largely responsible for the establishment of Averroism among medieval European intellectuals. As a rule, Aristotelian texts were of major interest to Catholic scholasticism during this time. The Church was seeking to reconcile ancient teachings with the presiding dogma of the Vatican, and the study of Aristotelian-attributed texts was, therefore, a key focus. The entrance of Scot's translations of Averroes' commentaries on Aristotle, actually upstaged the previously dominant Avicennism.¹⁸⁶ Significantly, Avicenna was another Andalusian Moor, whose philosophical and scientific writings had been very popular at European universities and among European thinkers. Avicenna's popularity was thereby replaced by Averroes as the Church-State of medieval Europe sought to make its theological tenets more rational and standardized.

Even after Alfonso X's death in 1284 the translator's "school" at Toledo continued. His brother-in-law Sancho of Aragon (Archbishop of Toledo) and another Archbishop, Gonzalo Garcia Gudiel, both continued to patronize the scholarly translations at Toledo. Both men possessed manuscripts on scientific works translated from the Arabic, and they eventually willed most of these texts to the Cathedral library. Evelyn Proctor says that the surplus of fourteenth century manuscripts attests to the feverish copying, studying and translating which continued at "holy" Toledo until the end of that century.¹⁸⁷ The famed

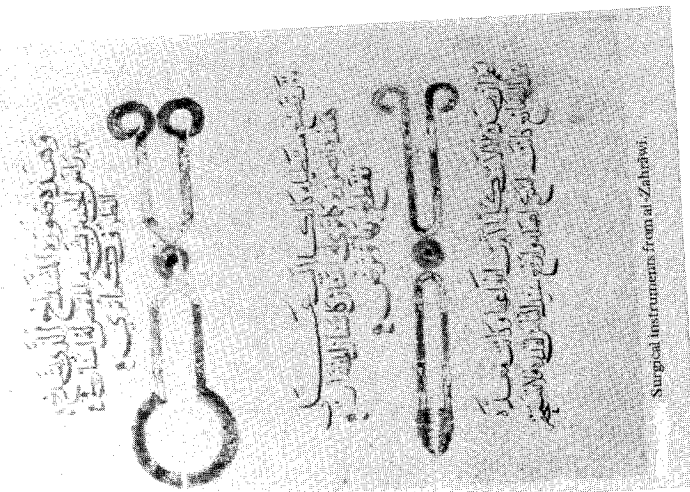
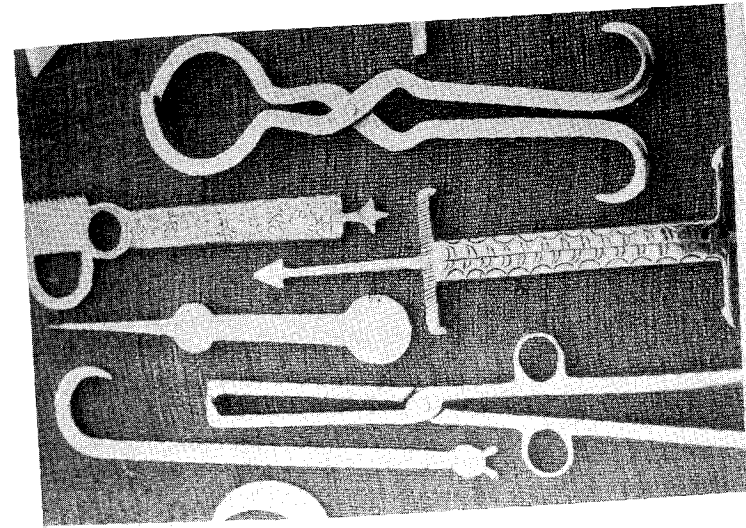

Surgical instruments from al-Zahrawi.

Figure 6a and 6b. A page from the Moorish Physician al-Zahrawi's surgical text; Kitab al-Tasrif, showing illustrations of surgical instruments and explaining their applications. [From a collection held in The Museum of The History of Medicine, Delhi, India and the Khudabakh library in Patna] Photo Credit: Robert Harding

Spanish cleric, Ramon Lull (1235–1315), would receive considerable recognition for having mastered the Arabic language well enough to open his own Christian school of Oriental studies.¹⁸⁸ In spite of their apparent aversion to the Islamic faith, many Catholic Europeans remained interested in studying the Muslim sciences and culture; ultimately, these less-than-Orthodox efforts fostered social and intellectual progress within the West.

There was very little that was ignored by the Western European translators.¹⁸⁹ Ibn al-Haitam's compendium on astronomy, al-Battani's canons and a commentary by Ali Ibn Ridwan ("Abenrodianus") on Ali Ibn-l-Rijal's ("Abenragel") astrological treatise, are all found in European translations. Abenragel's work appeared in Castilian (sp.) as *El Libro do los juicios de las estrellas*. Before his death, Alfonso X had also ordered this work translated into Latin under the title *Liber magnus et completas de iudiciis astrologiae*.¹⁹⁰

Alfonso X was a nationalist in that he wanted Castilian to become the official language of Catholic Spain. However, his interests in scholarship were clearly geared towards a large-scale intellectual enlightenment of the entire Christian world. According to Proctor, he hoped to produce standard books of reference for all of Christian Europe. Alfonso sought to educate the Christian layman as well as the cleric, which is why he usually chose the Spanish vernacular for translations of Moorish writings, rather than the more exclusive language of Latin.¹⁹¹ Sometimes he even commanded that the Vulgate translations be translated into other European languages. For example, Alfonso ordered that the *Mi'raj* (a commentary on the ascent of the Arab Prophet Mohammed into Paradise) be translated into French from the Castilian, after having been originally translated from the Arabic. Alfonso's notary, Bonaventura of Siena, completed the task in May of 1264. It was entitled: *Livre de leschiele Mahomet*.¹⁹² This fact reveals two important things. It reveals that there must have been significant relations between Spain and France for Alfonso to order a French translation. It also reveals an academic relationship and exchange with morophile Italy. The text's translator, Bonaventura, was one of a number of Italians who was in Alfonso's employ. In May of 1280, another Italian, Pietro de Regio, was sent by Alfonso as an ambassador to Aix-en-Provence to conduct diplomatic affairs and scholarly exchange with Charles of Salerno.¹⁹³ Alfonso often sent his scholar-translators out to serve as ambassadors of scholarship, and such a practice would have obviously given other Christian nations the opportunity to acquire the Moorish sciences of Andalus.¹⁹⁴

Alfonso X promoted Moorish erudition at every opportunity and his actions had great impact upon the future of Christian Spain and ultimately all of western Europe. Imamuddin suggests that the Spanish universities at Palencia (founded 1214 by Alfonso VIII), Salamanca (founded 1215), and Lerida (founded 1300 by Jaime II in Aragon), were all primarily established for the specific purpose of translating the Arabic treatises of the Moors into Latin. He

also goes on to say: "The first university in Christian Spain was founded at Palencia by Alfonso VIII in the thirteenth century and the teachers employed were Muslims and Jews."¹⁹⁵

Although Palencia and Salamanca pre-date Alfonso X, the establishment of an organized center for the translation and study of Moorish texts had already begun at Toledo, with Raimundo and Michael in the 12th century. Therefore, Alfonso X's support was not the impetus for the establishment of these two universities, but the interest in, and reliance upon, Moorish scholarship is again quite apparent. Lerida's growth, however, may have been directly influenced and supported by Alfonso X's thirteenth-century "school."

When one notes the period in which most of Europe's oldest and finest universities were established, one cannot but be struck by the proximity in time to the scientific flowering of Moorish Andalus and the establishment of European centers for the translation of Moorish documents.¹⁹⁶

- 1158 Bologna (It)
- 1180 Montpellier (Fr.)
- 1200 Oxford (Eng)
- 1209 Valencia (Cath. Sp.)
- 1223 Toulouse (Fr.)
- 1224 Naples (It)
- 1228 Padua (It)
- 1245 Rome (It)
- 1250 Salamanca (Cath. Sp.)
- 1257 Cambridge (Eng.)
- 1279 Coimbra (Sp/Port.)
- 1290 Lisbon (Sp/Port.)

The revelations of the above clearly support the contention that Europe's academic ascension was primarily born of its contacts with the Moors who were occupying European soil. The establishment of these famed European universities during the same time its scholars are studying the works of Moorish Andalus, even making them standard texts in astronomy, mathematics, medicine, etc., cannot simply be dismissed as coincidence. The extent of the Moorish impact upon all areas of western academia can be demonstrated.

The effect of the Moorish and Arab impact on the field of astronomy can be noted by European names for certain stars or constellations which have an Arabic origin. Acrab (aqrab=scorpion), Algedi (al-jadi=the goat), Altair (al-ta'ir=the flyer), Pherkard (farqad=the calf), and Deneb (dhanab=the tail). Even technical terms like azimuth (al-sumut) and nader (nadir) illustrate a Moorish/Arabic origin.¹⁹⁷ *Judwal*, the astronomy text of the Moor al-Zarqali (Arzachel), even became the standard text of Oxford University. Al-Zarqali's text contained various tables outlining the lunar months of the Coptics, Romans and Persians. It was translated at Toledo in the 13th century and became known as the "Alfonsine Tables" (after Alfonso X). Later, it was

revised by an Englishman named John of Lignieres, and finally made its way to Oxford in England, via the English Bishop, William Reade of Chichester.¹⁹⁸ Hence, we see another example of the migration of Moorish knowledge throughout the medieval European world.

There is no doubt that the medieval western Europeans were under the scientific tutelage of Andalusia's Moors. Beginning with monastic dependence upon Arabic treatises in the 10th century, Europeans translated and studied the texts of the African and Arab emigres to Iberia. Even a Catholic Pope studied in Moorish Andalus. Before ascending to the Papacy (renamed as Sylvester II), the famed Frenchman Gerbert of Aurillac (10th century) had travelled to Andalus to study the Moorish sciences.¹⁹⁹ In the medieval-era chronicle *Historia Pontifical* by Gonzalo de Illescas, Gonzalo tells us that Gerbert "came to the study of the liberal arts and mathematics at Seville, where the Moors had a principal school dedicated to those disciplines."²⁰⁰ He is also credited with having first introduced Arabic numerals to western Europe.²⁰¹

Moorish Medical Expertise and European Acquisition:

The medical expertise of the African Muslim came primarily to the West via the countries of Andalus and Sicily. Appropriately, both of these countries are well noted for their Africanization during the medieval period. Prior to the entry of the Moors and Arabs, many medieval Western Europeans traditionally confronted physical illness with "prayer, holy water, the touching of relics, and pilgrimages to holy places."²⁰² Except for a few herbs which were used for dressing sores, there was actually very little which could tangibly be done by the western European "healer."²⁰³ Meanwhile, Moorish expertise in surgery, pharmacology and medicine, were well known by the elite and scholarly few of Catholic Europe, as well as those adventurous common folk who had sojourned to the illustrious Andalusia.

Abu Marwan Ibn Zuhr ("Avenzoar") was the Sevillian-born Moor who had been the great Ibn Rushd's medical instructor.²⁰⁴ We remember that Avenzoar wrote a widely acclaimed text on tumors, abscesses, and therapeutics while serving as a court physician to both the Almoravid and Almohad courts.²⁰⁵ His text *Kitab al-Taysir*, which covered pharmacy and nutrition was translated into Latin (as *Thesir*) in 1280, and was studied at the major (and newly established) universities of Europe.²⁰⁶ One French historian, Paul Lacroix, informs us of how for centuries, the medical writings of Moorish scientists such as Avenzoar (Ibn Zuhr), Avicenna (Ibn Sina), Averroes (Ibn Rushd) and Mesue, were being printed at Venice "with marvellous rapidity." As late as 1495, a Parisian printer, Pierre Caron, published an herbal dictionary (*L'Arbolayre*) composed of extracts from medical treatises by Moors such as Avicenna, and a Sicilian-based African known as Constantinus Africanus.

The book would be reprinted years later under the Franco-centric title of *Grand Herbiere en Francois*.²⁰⁷

Constantinus Africanus was born in the eleventh century in Carthage. He studied in his African homeland and in Asia for 29 years, and gathered together various manuscripts on medical science. For reasons unknown, he came to Salerno Italy around 1063, bringing his expertise and valuable manuscripts to Europe. Encouraged by a European patron named Desiderius, who later became a Pope, Constantinus shared his knowledge with the Italian Kingdom.²⁰⁸ The original works and voluminous translations of medical texts by Constantine propelled the famed medical school at Salerno towards international renown.²⁰⁹ The contributions of this African scientist were officially recognized in the twentieth century. In 1930, the Eighth International Congress for the History of Medicine erected at Monte Cassino, Italy, a monument celebrating the contributions of Constantine, whose medical influence, the monument states, lasted 400 years.²¹⁰

For many centuries the mastery of Moorish medical works was required for obtaining medical degrees at Europe's most prestigious universities. In 1311, the Catholic Church even held a Council in Vienne, where they pronounced and endorsed the teaching of Arabic studies at the Universities of Rome, Paris, Bologna, Oxford and Salamanca.²¹¹ At Bologna, for example, Averroes' *Colliget* and Avicenna's *Canon* were the standard texts. European instructors, such as Tarenta the Portuguese at Montpellier, Cernisone of Parma at Padua, Mengo Biancheli at Pavia, and Bencio of Sienna at Bologna, were all well known teachers of Moorish medicine at their respective universities.²¹² Even in the 1500's, centuries after the Moors had lost control of Spain and Italy, there was a Spanish professor named Salaya, at Salamanca's university, who insisted upon the great need for an "Arabist" named Nunez. During this period of Catholic intolerance of Moorish religion and culture, Salaya still wanted the candidate Nunez to teach at the school. Salaya argued that "there is a great need for Arabic, especially among doctors of medicine ... Nunez is learned ... it should be awarded to him, were it only for the sake of his Arabic."²¹³ But Catholic resentment against the Moors would eventually lead to the loss of Spain's prosperity, since, in the interest of Vatican dominated politics and national cohesiveness, she systematically tried to erase any reminder of her Moorish dominated past.

Moorish Impact Upon Italian Kingdoms:

Al-Idrisi, often labelled by westerners as "the Strabo of the Arabic peoples," was a famed geographer and cartographer of the 12th century. Al-Idrisi was Moroccan born in the city of Ceuta in 1100, and he was educated at Cordova in Andalus. Al-Idrisi later travelled to Sicily to enter the service of the Norman ruler Roger II. Roger II was known for his great enthusiasm for

Moorish and Arab culture, particularly their sciences. Idrisi was commissioned by Roger II to construct a great silver globe.²¹⁴ Completed in 1154,²¹⁵ Idrisi's globe listed countries, seas, rivers, deserts, and major cities and even roads. Idrisi partitioned his globe into Seven Zones of the world. In addition, Idrisi wrote a companion geography book entitled *Nuzhat al-mushtaq fi ikhtiraq al-afaq*, later to be known as *The Book of Roger II*. The section of the book dealing with the African continent dwelt upon the customs of various African peoples, including their commercial activities, agricultural products, the fabric of their cultures.²¹⁶

Like his grandfather Roger II (both of whom are referred to as "the two baptized Sultans"), the Holy Roman Emperor, Frederick II of Sicily, was also infatuated with the culture and wisdom of the Moors. Frederick II who ruled from 1215-1250, surrounded himself with Muslim scholars and vassals.²¹⁷ So intense was his interest in Islamic cultures, that he was popularly believed to be a closet Muslim.²¹⁸ Frederick II founded the University of Naples in 1224, and there he established a curriculum which emphasized Moorish scholarship.²¹⁹ In fact, under Frederick II, theological studies at all Italian universities under his dominion ceased completely! Moorish Medicine and Law became the sovereign disciplines. No theological faculty would be seen at Naples until 1363.²²⁰ Prior to his ascension to the Spanish kingship, Alfonso X of Castile even established academic relationships with his Imperial contemporary Frederick II. After Frederick's death, he continued to send his Toledan-based scholars to the Sicilian kingdom as ambassadors of Andalusian Moorish scholarship. One such ambassador was John of Cremona, a gifted European student of Moorish erudition.²²¹ The learned Europeans of Frederick II's court were frequently educated outside of Catholic Europe. The most famous Italian mathematician of the period, Leonard of Pisa, was in Frederick's court, and he had been educated in Africa.²²²

Following the Moorish physicians of Andalus, Frederick II standardized medical licensing in 1231 throughout his kingdom. He required that medical candidates attain a "Royal License" before beginning their practice.²²³ This brought about a comprehensive regulation of physicians, surgeons, and pharmacists throughout Sicily.²²⁴ Even after Frederick's death, the patronage of Moorish (and Arab) scholars, and the study of Arabic texts continued. Both of Frederick's sons, Manfred and Charles, remained patrons of Muslim scholarship.²²⁵ Frederick II had amassed quite a number of books by Moorish and Arab scholars and, upon his death, his son, Charles of Anjou, gave many of these to the Vatican as gifts.²²⁶ One need not spell out the irony and significance of this fact.

France and The Influence of Moorish Erudition:

French academia and cultural development owes a heavy debt to Moorish

culture and erudition. At Montpellier, the only medical school outside of Andalus to rival Salerno,²²⁷ translated works by Avicenna and Constantine "the African" (Africanus), were standard texts of study for medical licensing.²²⁸ Moorish medical and surgical techniques dominated the school. O'Callaghan also brings attention to the fact that the French school rested within the dominions of the Aragonese monarchs.²²⁹ In discussing the city of Montpellier, Rashdall adds: "Many of the original inhabitants were Spaniards who had long resided among the Moors."²³⁰ There lay the opportunity for cultural and scientific borrowing.

At one point Lacroix, who was a nineteenth century European historian, attempted to malign elements of Moorish medical theories. He criticized the Moorish doctors for insisting that the seasons and lunar periods had direct effects upon the human body. He was also critical of the Moors' belief that the blood rose during the day and descended into the body's lower extremities at night, and that phlegm subsided during the night as well.²³¹ It is amazing, therefore, when we consider the recent "revelations" of Western science about the effects of the Moon on menstruation in women, and the drainage of the sinus cavity during sleep. Aside from pointing out that lunar stages evidently have an effect upon the mental states of many people, Western psychiatrists have also illustrated how the various seasons can affect biochemical reactions which produce strong psychological and physical changes.

Interestingly enough, the city of Montpellier rests upon the ruins of Maguelone, a town where thousands of Moors had taken refuge after retreating from the destructive armies of the Catholic ruler Charles ("the hammer") Martel in 737.²³² The town retained a large Moorish population, and McCabe writes: "The Moors made a lasting impression on the people of southern France, and for years these people remained culturally in contact with the Moors." He continues: "The passes of the Pyrenees were the real source of the first inspiration of barbaric Europe and the South of France soon became the most prosperous and most heretical region in (Christian) Europe."²³³ This is very revealing when we consider that the French of the northernmost regions were still very much into the brutal (and legal) practice of ordeals by fire & water, as late as the 13th century.²³⁴ In contrast, the Moors were a people of written and just laws, hospitals, public baths, universities and great libraries. The Medievalist Hastings Rashdall informs the reader in a footnote, that Arles and Narbonne, French medical schools near Montpellier, are believed to have been established by Moors and Jews.²³⁵ Lectures on Moorish medical techniques were still being given at Montpellier as late as the 17th century.²³⁶

The school of Chartres, which was the forerunner to the University of Paris, was the first French school devoted to scientific studies. Unlike so many other Western institutions, Chartres did not begin as a theologically-focused Cathedral school, and Vallicrosa informs us how most of its students travelled to the Ebro region of Moorish Spain for more extensive studies under the Moors.²³⁷

At Chartres, the books of Constantinus Africanus, Averroes and Avicenna were extensively used.²³⁸ Until other European schools (like Oxford) could obtain greater access to Moorish erudition, French schools like Chartres acted as an international center for students from England, Normandy, various Germanic states, Burgundy and Finland.²³⁹

In the twelfth century most English scholars and students had travelled into Paris for their education.²⁴⁰ This changed, however, as the English learned all they could at the French schools and elsewhere. England's institutions improved and English society acquired greater academic independence. Initially, Oxford was a kind of branch campus of the University of Paris. Rashdall says, "The University [Oxford] was originally in all probability a colony of Parisian schools transferred to English soil."²⁴¹ Like Montpellier [and Chartres] and Bologna in Italy, Oxford did not originate as a Cathedral school²⁴² under the regimented supervision of Vatican-sanctioned clerics. Consequently, such European academic institutions were able to adopt Moorish learning without the Church's typically debilitating restrictions. Incidentally, one of the first instructors at Oxford was a man named Adam de Marisco,²⁴³ whose name translates as Adam "of the Moors" or "of Moorish blood."

What remained of ancient scholarship had suffered a grave decline in Europe, prior to the coming of the Moors and Arabs. With the exception of some Irish schools and a handful of monasteries in northern Spain, almost no classical learning (i.e. the teachings of the Ancients) was taking place under Christian Europeans of the medieval era.²⁴⁴ A European Catholic male was considered to be scholarly/educated if he could read and meditate upon the Bible, and was familiar with the biographies of the Saints (hagiography).²⁴⁵ Chejne summarizes very well the medieval European's predominant perspective:

Western man was preoccupied with the theocentrism of the Church to the extent that he negated the anthropocentrism of the classical period and considered it lacking in Supreme Truth. For centuries, truth could — within the framework of Church policy — be conceived by faith alone, as opposed to reason.²⁴⁶

Rashdall excuses Middle Age Europe's de-emphasis upon reason and secular knowledge of the natural world. He states: "The Christianized barbarian recognized the spiritual, if he did not recognize the intellectual, needs of humanity."²⁴⁷

Needless to say, the sciences were certainly not flourishing among such Europeans. But following the coming of the Moors, Arabs and Muslim Persians, intellectual light shone over the European nations. The written research of Moorish scholars was an indispensable base upon which western Europe's scholarly inquirers could become scientists and intellectuals. Christian and Jewish translator-scholars carried into western Europe the written wis-

dom of the Andalusian Moors as well as their own observations on Muslim learning. As these European scholars then traversed through Christian Europe, they left behind them traces of their acquired learning. Even the educational histories of revered European thinkers such as Thomas Aquinas and Roger Bacon, reveal an intellectual dependency upon the erudition of the Moors.

The famed and canonized Thomas Aquinas (1225–1274) had been a mendicant friar (Monk) of the Dominican Order. This Italian born cleric first attended Monte Cassino and then Frederick II's University of Naples, with its Moorish dominated curriculum.²⁴⁸ An analysis of Aquinas' academic writings illustrates a considerable dependence upon Averroes' commentaries.²⁴⁹ Given this, I think it is evident that Aquinas used Averroes' evaluations of Aristotelian-attributed texts, in order to ameliorate the dogmas of Catholic scholasticism, for which he is so revered. The Spanish historian, Asin-Palacios, revealed that the Mendicants had established a tradition of entrusting to their brother-scholars, translations of Moorish and Judaic philosophical texts. In this way, fellow Catholic thinkers were able to utilize the academic materials of their Christian brethren at other monastic centers. The Order's excellent organization gave Aquinas access to several important treatises and works²⁵⁰ (as did the Univ. of Naples), which he then used in his attempts to assault Islamic theology, and in his development of a more rational Christian theology. Given these facts, it is even more significant that Roger Bacon, another monastic savant of Catholic Scholasticism, was also a mendicant.

Roger Bacon, a Franciscan monk, was an Englishman who was born in 1214 (died 1294).²⁵¹ In assessing the great significance of Roger Bacon, Lacroix states:

He [Bacon] represents more accurately than anyone else in the thirteenth century the movement which was already urging so many minds to the study of nature, and to the experimental method.²⁵²

I would simply qualify Lacroix's assessment by saying that his reference to "anyone" is relative to Europeans, for Andalusian Moors were in fact provided the catalyst and foundation for the very 13th century movement of which Lacroix speaks.

Strangely, Bacon is sometimes criticized by European historians for having been too secure with Moorish scientific and philosophical concepts and observations. Yet, the basic creed of Roger Bacon was that theology and philosophy had to be studied philologically and historically, while natural science had to be approached mathematically and experimentally.²⁵³ This very Moorish contention sounds very reasonable and acceptable to me. In fact, Bacon was highly successful as a scientist and he was often considered ahead of his time, at least in comparison with his Christian European contemporaries. He was particularly lauded for his alchemical skills, and he is credited

with producing a gunpowder made of phosphorus and saltpetre.²⁵⁴ But what is perhaps most intriguing about this acclaimed English student of Moorish scholarship, is his fate.

McCabe informs us that Bacon spent almost twenty years under some sort of house arrest. During that time, his monastic superiors prohibited him from reading or writing.²⁵⁵ In fact, Bacon's writings would not even be printed in England until the eighteenth century. Even though these circumstances strongly suggest that Bacon was being censored by some establishment or authority, the conservative medievalist Hastings Rashdall insists (in a footnote) that it had nothing to do with "any sort of persecution or theological reprobation." In reference to English academia's incredible delay in failing to print Bacon's writings earlier, Rashdall asserts that it was simply "due to their desultory and unsystematic character" and he discusses it no more.²⁵⁶ But owing to Bacon's great fame as a pioneering scholar of medieval Europe, it is rather difficult to believe that it would take five centuries before England's savants would undertake the task of compiling their fellow Englishman's writings for print. It seems more likely that Bacon was censored by Catholic and perhaps other prominent authorities, because his focus upon and reverence for Moorish erudition was simply too heretically extensive for that particular time. Others like Michael Scot, of whom we spoke earlier, were often ostracized and censored as "witches" because of their studies in Moorish sciences and philosophies.

The last medieval European of considerable fame, which we will mention, is Adelard of Bath (1090–1150). Born in England, this 12th century catalyst of Moorish erudition, also studied in Palestine and Cilicia [an ancient land of southeast Asia Minor].²⁵⁷ One of Adelard's most widely known translations was of al-Khwarizmi's *Arithmetic*.²⁵⁸ Adelard's writings covered such areas as trigonometry, astrology, falconry, philosophy, and alchemy. In his widely popular text *Questiones naturales*, Adelard confesses that his text is merely the knowledge of "his Arabs," as if to remove himself of responsibility for its contents, or perhaps to display an unusual degree of recognition for the Muslim peoples who had educated him. The work discussed the growth of plants and the natural characteristics of certain animals. It explained the night vision in certain animals as resulting from a difference in the humor of their eyes. Other sections of the work discussed the network of muscles and veins in man, and even the causes of tides and earthquakes.²⁵⁹ Interestingly enough, all these observations and scientific revelations already existed in the treatises of Andalusian scholars, and let us remember that Andalusian Moors were particularly astute in both these disciplines of natural science and medicine. However, it is possible that elements of his knowledge came from other Muslim countries, as he was known to have traveled to them.

Whether he did it for reasons of personal safety or as homage to Muslim erudition, Adelard constantly attributed his knowledge to the Islamic peoples.

He began his text *Astrolabe* by crediting his knowledge to "the opinions of the Arabs." Adelard's influence would last centuries after his death, and this apprentice of "Moorish/Arab" erudition, would still be found among the scientific contentions of men such as the Italian savant, Pico della Mirandola (15th cent.).²⁶⁰ One must consider the significance of Adelard's habit of consistently attributing the contents of his great works to "his Arabs" and "the opinions of the Arabs." At a later date I would like to secure the original Latin text, in order to see for myself what term he used. For it would not surprise me to find *moros* or *maures* inappropriately translated by some European historians as "Arab" in the interest of maintaining "racial" confusion about the highly significant and revealing "Medieval" period.

Conclusion:

This essay has revealed the extensive impact of the Africanized Iberian nation upon the nearby European nations of the medieval period. The cultural and scientific superiority of the Moors impacted upon the intellectual and cultural progress of Europeans. We have seen how Andalus, with its schools, scholars, hospitals, trades, architecture, devout regard for education and religious tolerance, lured many Europeans into her borders. We recall the Nun of Saxony, speaking of the grandeur of Moorish Spain as if she had been bewitched by it. Indeed, we recall that the official stance of the Catholic Church was that the science of the advanced Moorish society was partly due to witchcraft. Yet, hypocrisy is clearly evident, as the extensive clerical interest in Moorish and Muslim scholarship in general led to the education and writings of such giants of Western Intellectualism as Abelard of Bath, Thomas Aquinas, and Roger Bacon. The obvious conclusion of all this is that the Church recognized the theological threat posed by such an advanced society as Islamic Andalus. Powerful Church officials recognized that they could not assert the Vatican's political and social authority in the midst of a people like the Islamic Moors of Andalus. These people—like the Arab and Persian Muslims—were designated as "heathens." Yet, such heathens were healing the sick with great success, living comfortably and lavishly, operating their society with relative order, fairness, and just laws. Why, these heathens even smelled nice, and they were right there in western Europe's backyard!

For centuries "maverick" Catholic rulers such as Frederick II of Sicily and Alfonso X of Castile, engaged the Moors and tapped into their scholarship. Much to the dismay of various high-level Catholic Authorities, men like Alfonso X and Frederick II surrounded themselves with Moors and other Muslims, and they partook of their considerable erudition for the greater good of their own Catholic Kingdoms. Centers of translation, such as the one at Toledo, sought to speed up the process by which European Catholics could acquire access to the sciences and knowledge of the Moors. Under Alfonso X,

Toledo outstripped the other local centers of study and translation at Barcelona, Tarazona, Leon, Segovia, and Pamplona, as well as monastic centers of translation like Ripoll. Even French centers such as those at Toulouse, Beziers, Narbonne and Marseilles, could not keep up with Alfonso's Toledo. Strangely, after all the centuries of scholarly acquisition, and scientific tutelage under the Moors, Europe's masses would ultimately remain ignorant of much of the Moorish erudition. The use of *al-kuhl*/alcohol as an antiseptic, and proper habits of personal hygiene for good health, would largely disappear from Europe's societal memory until Charles Lister introduced antiseptics several centuries later.

Within the histories of such selective European societies as Freemasonry, Rosicrucianism, and even the Shriners, one can find allegorical remnants which reveal the considerable historical debt of the West to Moorish/Muslim erudition. In fact, specific references to the "medieval" Moorish connection to Masonry can be found. Even the name "Mason" means son of a Moor.

Evidently, as the Church grew stronger through its infamous Inquisition and the final downfall (by the 16th cent.) of Moorish power in Europe, the Church could more easily assert control within European society. Traditionally, the official posture of the Church was to warn members to stay away from Moorish scientific practices and philosophies. Ironically, however, it was Catholic clerics who would eventually bring much of the knowledge of the Muslims into the Church and many educational centers in the West. But then again, any intellectual reform had to come from within the Church cadre, since the Church held such great power. The Catholic Church was the political, social, and religious foundation of medieval European society.

At several periods in its history the Vatican displayed some noteworthy tolerance towards the study of Moorish scholarship by its members. But, for the most part, the Church Officials and the Clerical Elite publicly frowned upon the secular wisdom introduced by the Muslim peoples, in spite of the fact that many Clerics had themselves studied Moorish sciences and philosophies. It was as if these men wanted the Catholic masses to remain ignorant so as to allow easier control of the society. Such Catholic Bureaucrats of the period evidently felt threatened by a community which was being taught how to rationalize about the natural world, the Creator, and their personal condition in society. Moorish society and scholarship was espousing and inferring such concepts, and many European Catholics regarded this as dangerous. Hence, many students of Moorish erudition had to take their acquired wares underground or face the fate of European intellectuals like Jordano Bruno, who was burned for the heretical conduct of embracing Pantheistic doctrines regarding the nature of the God-Force and Man (*Handbook In The History of Philosophy* by Albert E. Avey, Barnes & Noble, New York, 1961.). Pantheism is a common criticism offered by Christian European intellectuals who evaluate both Islam and other traditional African theologies. I am convinced that

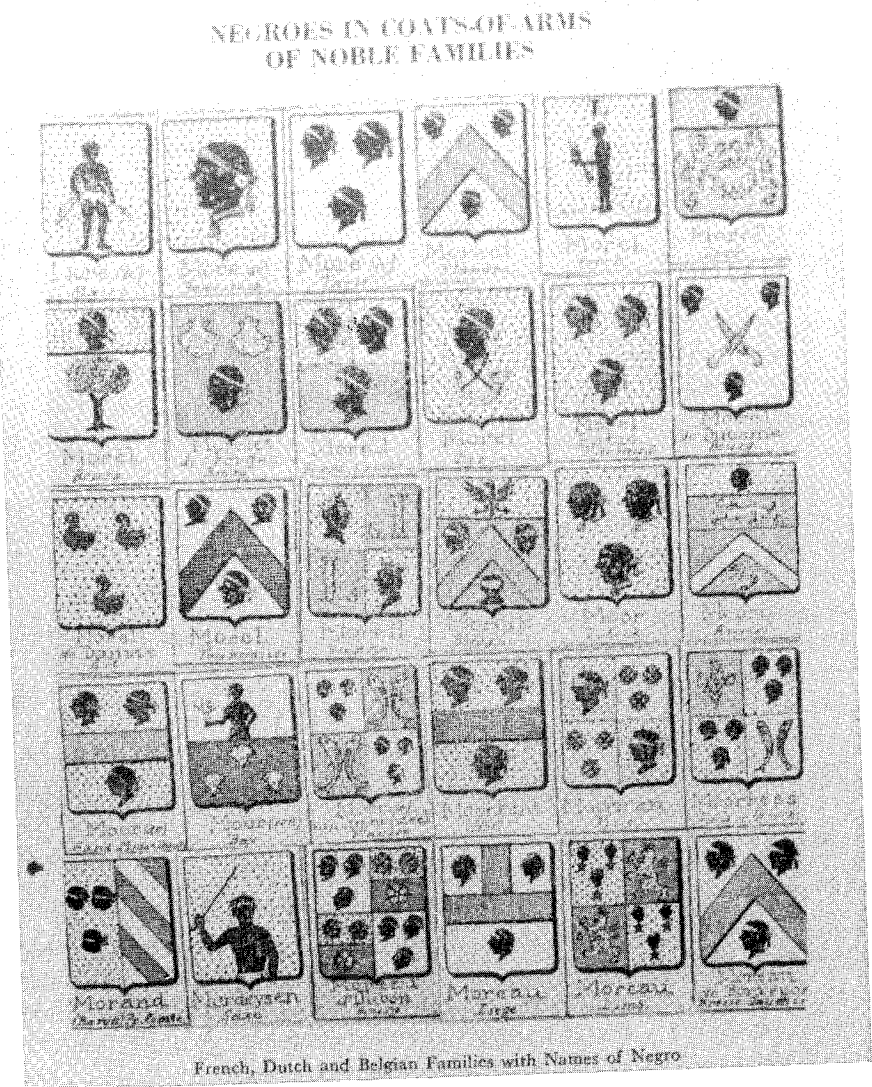

Figure 7. This pictorial shows a few of the numerous European family names which have as their progenitor an African Moor or so-called "Negro."

Bruno was asserting Moorish (as well as Kemetic) philosophical and religious principles with which he came in contact during the course of his studies.

Let us not forget that Moorish/Muslim erudition encompassed the teachings of the ancient Kemites/Egyptians. There are many historical correlations between the Moors and the ancient Kemites. Appropriately, those European nations where the Catholic Church was less politically powerful, such as France, particularly the southern regions, were able to benefit the most from the scholarship and cultural advances of the Muslim people. The highly advanced Albigensians (also known as Cathars) at Languedoc in southern France offer a good example. Michael Bradley discusses this French community in his *Iceman Inheritance*, and describes how, in the thirteenth century, the Pope launched a genocidal Crusade against these men, women and children who were labelled heretics. Again, the community's inspiration appears to have been the Moors to their south, from the nearby borders of Andalus. In contrast, Catholic Spain's "Reconquista" (reconquest from the Moors) and the religious fanaticism and intolerance it promoted ultimately affected Spain's progress.

Monroe tells us of how the economic and political interests of the new Catholic Spanish state compelled Spaniards to destroy many Moorish manuscripts that the Conquistadores acquired after the fall of Granada in 1492. According to Pascual Gayangos, Cardinal Jimenez de Cisneros ordered the burning of nearly eighty-thousand books in the public square of Granada. The Cardinal is said to have asserted that since the books were all in Arabic, they were Korans, and therefore dangerous.²⁶¹ Reason dictates that the books were not all Korans and the Cardinal knew that. His actions displayed not just religious bigotry but hatred for the superior Moorish culture which had threatened Catholic European hegemony at that time. Who knows what great literature and scientific knowledge was lost in the flames? Let us recall the great need for an "Arabist" at Salamanca (less than twenty years after this event), in order to rejuvenate the fledgling medical profession of Spanish society.

In sum, the medieval European had several means of acquiring the wisdom of the Andalusian Moor: Direct study at any of the countless Moorish schools (madrasas) or universities like Cordova and Granada, the purchasing of books in Andalus, such as from Cordova's 20,000 recorded booksellers, instruction from Moorish Teachers at European schools inside and outside of the Iberian peninsula, the extensive standardized use of translated Moorish texts at European institutions, as well as instruction from Moorish-trained Jewish and Christian European teachers. Indeed, all these modes of acquisition were employed by curious medieval Europeans who recognized the praxis and beauty of Moorish erudition and culture. Although like the Cat, *curiosity* sometimes killed such Europeans trapped by the vacillating and unpredictable conduct of the Church's leaders, Moorish and Muslim scholarship still propelled



Figure 8. In this illustration of the Moroccan Emperor Mulay Arsheid (on the right), we can easily see the distinctly African features which the European illustrator gave to this 17th century Moroccan Emperor. On the left wearing the ear ring is General Bassa, one of Mulay Ismael's Army commanders.



Figure 9. Moroccan "berber" girl whose phenotype clearly identifies her as African. [Moroccan Tour book]

western European societies far beyond the dark age into which, after the borrowed brilliance of Greece and Rome, so many had fallen. It propelled them beyond the dark cage within which a Clerical Elite, even when given the keys to an Enlightenment, kept the masses imprisoned for centuries.

Notes

1. Anwar Chejne, *Muslim Spain: Its History and Culture* (Minneapolis: The University of Minnesota Press, 1974), p. 126
2. Titus Burckhardt, *Moorish Culture in Spain*. Translated by Alissa Jaffa. (N.Y.: McGraw-Hill Co., 1972)./Forward/
3. Wayne Chandler's "The Moors: Light of Europe's Dark Ages." Ivan Van Sertima ed. *African Presence In Early Europe*. (New Brunswick N.J.: Transaction Books, 1985), p. 149.
4. *Ibid.*
5. Cheikh Anta Diop, *The African Origin of Civilization*. Translated by Mercer Cook. (Westport Conn.: Lawrence Hill & Co., 1974), p. 53.
6. *Ibid*, p. 52.
7. Van Sertima ed., *African Presence In Early Europe*, p. 144.
8. Diop, p. 128.
9. *Ibid*, p. 125.
10. *Ibid*, p. 151.
11. *Ibid*, p. 127.
12. *Ibid*, p. 126-7.
13. Richard Brace, *Morocco, Algeria, Tunisia*. (Englewood Cliffs N.J.: Prentice Hall Inc., 1964), p. 7-8.
14. *Ibid.*
15. Luiz Vazquez de Parga ed., *Textos Historicos En Latin Medieval Siglos VIII-XIII* vol. 23 (Madrid: Escuela De Estudios Medievales C.S.I.C., Comision De Latin Medieval, 1952).
16. Enrique Sordo, *Moorish Spain* (N.Y.: Crown Publishers, 1963), p. 18.
17. Diop, *The African Origin of Civilization*, p. 145.
18. Joseph McCabe, *The Moorish Civilization In Spain* (Girard Kan.: Haldemar-Julius co., 1927), p. 53.
19. *Ibid*, p. 9.
20. Brace, *Morocco, Algeria, Tunisia*, p. 8.
21. James T. Monroe, *Islam and The Arabs In Spanish Scholarship* (Leiden: E.J. Brill, 1970), p. 182.
22. Diop, *The African Origin of Civilization*, p. 145.
23. *Ibid*, p. 128.
24. J.A. Rogers, *Sex and Race vol I* (St Petersburg Fl: Helga M. Rogers, 1967), p. 96.
25. *J.A. Rogers, *Nature Knows No Color Line*, also has many excellent illustrations.
26. William Shakespeare's *Othello*, printed by Bantam Books.
27. Frances Cress Welsing, "The Cress Theory of Color Confrontation and Racism (White Supremacy)," (Wash D.C.: C-R Publ., 1970).
28. De Lacy O'Leary, *Arabic Thought and Its Place In Western History* (London: Kegan Paul, Trench, Trubner & Co., 1922), p. 234.
29. *Ibid*, p. 235.

30. Van Sertima ed., *African Presence In Early Europe*, p. 144.
31. O'Leary, *Arabic Thought and Its Place in Western History*, p. 235-6.
32. Aziz Lotfi, "Afrocentricity And The Berber-Arabo-Muslim Heritage of North Africa" (Unpublished Paper/Dept of African American Studies class/Temple Univ/AAS400, 1990), p. 12.
33. *Ibid.*
34. *Ibid.*, p. 16.
35. E.W. Bovill, *The Golden Trade of The Moors* (London: Oxford University Press, 1968), p. 45.
36. Colin Smith, *Christians And Moors In Spain vol I: 711-1150* (Warminster Eng.: Aris & Phillips Ltd., 1988), p. 10-11.
37. *Ibid.*, p. 24-7.
38. Joseph O'Callaghan, *A History of Medieval Spain* (Ithaca: Cornell University Press, 1975), p. 150-1.
39. Chejne, *Muslim Spain*, p. 134.
40. O'Callaghan, p. 158-60.
41. Chejne, p. 111.
42. McCabe, *The Moorish Civilization In Spain*, p. 140.
43. Chejne, p. 185.
44. *Ibid.*, p. 5.
45. O'Leary, *Arabic Thought And Its Place In Western History*, p. 240-1
46. Joseph McCabe, *The Splendours of Moorish Spain* (London: Watts & co., 1935), p. 249.
47. Jaime Vicens Vives, *Approaches To The History of Spain*. Translated by Joan Connelly Ullman. (Berkeley: University of California Press, 1970), p. 21.
48. Brace, *Morocco, Algeria, Tunisia*, p. 23.
49. O'Callaghan, *A History of Medieval Spain*, p. 152.
50. *Ibid.*
51. *Ibid.*, p. 133.
52. McCabe, *The Moorish Civilization In Spain*, p. 16.
53. O'Callaghan, *A History of Medieval Spain*, p. 309-10.
54. Vives, *Approaches To The History of Spain*, p. 34-5.
55. O'Callaghan, p. 145.
56. *Ibid.*, p. 186-7.
57. *Ibid.*
58. Vives, *Approaches To The History of Spain*, p. 31.
59. O'Callaghan, *A History of Medieval Spain*, p. 146-7.
60. Chejne, *Muslim Spain*, p. 352.
61. *Ibid.*, p. 136.
62. Robert Ignatius Burns, *Moors and Crusaders In Mediterranean Spain: Collected Studies* (London: Variorum Reprints, 1978), p. 453.
63. Burckhardt, *Moorish Culture In Spain*, p. 53.
64. Charles Homer Haskins, *Studies In The History of Medieval Science* (N.Y.: Frederick Ungar Publ., 1960), p. 257.
65. Chejne, *Muslim Spain*, p. 136-7.
66. *Ibid.*, p. 245.
67. *Ibid.*
68. Burckhardt, *Moorish Culture In Spain*, p. 87.
69. McCabe, *The Moorish Civilization In Spain*, p. 18.
70. Sordo, *Moorish Spain*, p. 32.
71. McCabe, *The Moorish Civilization In Spain*, p. 20.

72. *Ibid.*
73. *Ibid.*
74. Chejne, *Muslim Spain*, p. 406.
75. *Ibid.*
76. *Ibid.*, p. 367-8.
77. Sordo, *Moorish Spain*, p. 18.
78. S.S. Imamuddin, *Some Aspects of The Socio-Economic and Cultural History of Muslim Spain: 711-1492* (Leiden: E.J. Brill, 1965), p. 83.
79. *Ibid.*, p. 88-90.
80. *Ibid.*, p. 73.
81. *Ibid.*, p. 77.
82. *Ibid.*, p. 73.
83. *Ibid.*, p. 74.
84. *Ibid.*, p. 80-1.
85. O'Callaghan, *A History of Medieval Spain*, p. 305-6.
86. Van Sertima ed., *African Presence In Early Europe*, p. 164-6.
87. *Ibid.*, p. 168.
88. *Diccionario De La Lengua Espanol: Vegesima Edicion Tomo II* (Madrid: Real Academia Espanola, 1984).
89. Henry Coppee, *History of the Conquest of Spain By The Arab-Moors vol II* (Boston: Little, Brown & Co., 1881), p. 235.
90. Van Sertima ed., *African Presence In Early Europe*, p. 168.
91. O'Callaghan, *A History of Medieval Spain*, p. 321-2.
92. Francois L. Ganshoff, *The Middle Ages: A History of International Relations*. Translated by Remy Ingles Hall. (N.Y.: Harper & Row, 1970), p. 201.
93. Chejne, *Muslim Spain*, p. 158.
94. *Ibid.*, p. 166.
95. *Ibid.*, p. 181.
96. Imamuddin, *Some Aspects of The Socio-Economic and Cultural History of Muslim Spain*, p. 137.
97. S.S. Ahmad, *The Moorish Spain* (Karachi Pakistan: Farooq Kitab Ghar Publ., 1972), p. 158.
98. Chejne, *Muslim Spain*, p. 347.
99. *Ibid.*, p. 167.
100. Imamuddin, *Some Aspects of The Socio-Economic and Cultural History of Muslim Spain*, p. 139.
101. Haskins, *Studies In The History of Medieval Science*, p. 9.
102. *Ibid.*, p. 10.
103. Chejne, *Muslim Spain*, p. 148-9.
104. Paul Lacroix, *Science and Literature In The Middle Ages And The Renaissance* (N.Y.: Frederick Ungar Publ., 1964), p. 80.
105. Jose M. Millas Vallicrosa, *Las traducciones orientales en los manuscritos de la Biblioteca Catedral de Toledo* (Madrid: Consejo Superior De Investigaciones Cientificas Instituto Arias Montano, 1942), p. 4.
106. Chejne, *Muslim Spain*, p. 313.
107. Vallicrosa, p. 5.
108. Hastings Rashdall, *The Universities of Europe In The Middle Ages, vol I* (London: Oxford University Press, 1936), p. 70.
109. George G.M. James, *Stolen Legacy* (London: The African Publication Society, 1972). p. 39.
110. *Ibid.*

111. *Ibid.*, p. 42–5.
112. *Ibid.*, p. 129–30.
113. *Ibid.*, p. 125.
114. *Ibid.*, p. 39.
115. Ivan Van Sertima, *They Came Before Columbus* (N.Y.: Random House, 1976), p. 170.
116. *Ibid.*
117. Fazhur Rahman, *Health and Medicine In The Islamic Tradition: Change and Identity* (N.Y.: Crossroad Publ., 1987), p. 18.
118. Imamuddin, *Some Aspects of the Socio-Economic and Cultural History of Muslim Spain*, p. 162.
119. Chejne, *Muslim Spain*, p. 351.
120. *Ibid.*, p. 357.
121. Imamuddin, *Some Aspects of the Socio-Economic and Cultural History of Muslim Spain*, p. 162-4.
122. Chejne, p. 167.
123. Ahmad, *The Moorish Spain*, p. 143.
124. McCabe, *The Moorish Civilization In Spain*, p. 20.
125. *Ibid.*, p. 248.
126. Ahmad, *The Moorish Spain*, p. 160–1.
127. Monroe, *Islam And The Arabs In Spanish Scholarship*, p. 3.
128. Chejne, *Muslim Spain*, p. 352.
129. Imamuddin, *Some Aspects of the Socio-Economic and Cultural History of Muslim Spain*, p. 148–9.
130. Chejne, p. 170–3.
131. *Ibid.*, p. 175–5.
132. *Ibid.*
133. *Ibid.*, p. 344.
134. Sordo, *Moorish Spain*, p. 32.
135. Chejne, *Muslim Spain*, p. 136./Sordo says a half million people lived in Cordova: p. 32.
136. *Ibid.*, p. 162.
137. Sordo, *Moorish Spain*, p. 32.
138. McCabe, *The Moorish Civilization In Spain*, p. 20.
139. Sordo, p. 18.
140. McCabe, *The Moorish Civilization In Spain*, p. 33.
141. *Ibid.*, p. 21.
142. Imamuddin, *Some Aspects of The Socio-Economic and Cultural History of Muslim Spain*, p. 149–50.
143. Rashdall, *The Universities of Europe In the Middle Ages vol I*, p. 351.
144. Ahmad, *The Moorish Spain*, p. 254.
145. Chejne, *Muslim Spain*, p. 356.
146. Imamuddin, *Some Aspects of The Socio-Economic and Cultural History of Muslim Spain*, p. 150.
147. Rashdall, *The Universities of Europe In The Middle Ages vol I*, p. 246.
148. Chejne, *Muslim Spain*, p. 322.
149. Imamuddin, *Some Aspects of The Socio-Economic and Cultural History of Muslim Spain*, p. 193.
150. Chejne, *Muslim Spain*, p. 316.
151. Rashdall, *The Universities of Europe In The Middle Ages vol II*, p. 127.
152. *Ibid* vol I, p. 246.

153. Imamuddin, *Some Aspects of The Socio-Economic and Cultural History of Muslim Spain*, p. 159.
154. Jose M. Millas Vallicrosa, "La Corriente De La Traducciones Cientificas De Origen Oriental Hasta Fines Del Siglo XIII," *Journal of World History vol 2 1954–5*, p. 404–5.
155. Smith, *Christians and Moors In Spain vol I*, p. 55.
156. *Ibid.*, p. 57.
157. *Ibid.*
158. *Ibid.*, p. 59.
159. Imamuddin, *Some Aspects of The Socio-Economic and Cultural History of Muslim Spain*, p. 188–9.
160. Haskins, *Studies In The History of Medieval Science*, p. 12.
161. *Ibid.*, p. 17.
162. Evelyn S. Proctor, *Alfonso X of Castile* (Westport Conn: Greenwood Press, 1980), p. 6.
163. *Ibid.*, p. 3 & 16.
164. Ahmad, *The Moorish Spain*, p. 250.
165. Imamuddin, *Some Aspects of the Socio-Economic and Cultural History of Muslim Spain*, p. 163.
166. Chejne, *Muslim Spain*, p. 356.
167. Imamuddin, p. 163.
168. Ahmad, *The Moorish Spain*, p. 248.
169. Chejne, *Muslim Spain*, p. 356.
170. *Ibid.*
171. Imamuddin, *Some Aspects of the Socio-Economic and Cultural History of Muslim Spain*, p. 163.
172. Chejne, *Muslim Spain*, p. 357.
173. Imamuddin, p. 164.
174. *Ibid.*
175. S.M. Ahamed Udayar, "Sri Lanka Moor Physicians (Hakeems) To The Sinhala Kings," *Moor's Islamic Cultural Home Souvenir IV 1977–1982* (Colombo, Sri Lanka: Mohinudeen Hamzah, 1983), p. 171.
176. Imamuddin, p. 161–2.
177. Benjamin Lewis, *The Muslim Discovery of Europe* (N.Y.: W.W. Norton & Co., 1982), p. 125.
178. O'Callaghan, *A History of Medieval Spain*, p. 313
179. *Ibid.*
180. Vallicrosa, *Las traducciones orientales en los manuscritos de la Biblioteca Catedral de Toledo*, p. 8-9.
181. Haskins, *Studies In The History of Medieval Science* p. 10.
182. *Ibid.*, p. 11.
183. Proctor, *Alfonso X of Castile*, p. 8.
184. Haskins, p. 272–3, & 277.
185. *Ibid.*, p. 291.
186. Vallicrosa, *Las traducciones orientales en los manuscritos de la Biblioteca Catedral de Toledo*, p. 10.
187. Proctor, *Alfonso X of Castile*, p. 14.
188. Chejne, *Muslim Spain*, p. 403.
189. Proctor, p. 6.
190. *Ibid.*, p. 12–13.
191. *Ibid.*, p. 3.

192. *Ibid*, p. 16.
 193. Proctor, p. 130.
 194. *Ibid*, p. 123.
 195. Imamuddin, *Some Aspects of the Socio-Economic and Cultural History of Muslim Spain*, p. 137-8 [The dates for the founding of the Spanish universities of Palencia, Lerida, and Salamanca, are from Monroe's text *Islam And The Arabs In Spanish Scholarship*, p. 205].
 196. Lacroix, *Science and Literature In The Middle Ages and The Renaissance*, Appendix.
 197. Chejne, *Muslim Spain*, p. 350.
 198. Proctor, *Alfonso X of Castile*, p. 9.
 199. McCabe, *The Splendours of Moorish Spain*, p. 241.
 200. Jose Rodriguez ed. *Memorial Historico Espanol* (Madrid: Imprenta De La Real Academia De La Historia, 1851), p. 388-9.
 201. Vallicrosa, *Journal of World History*, p. 408.
 202. Lacroix, *Science and Literature In The Middle Ages and The Renaissance*, p. 143.
 203. *Ibid*.
 204. Imamuddin, *Some Aspects of The Socio-Economic and Cultural History of Muslim Spain*, p. 163.
 205. Chejne, *Muslim Spain*, p. 356.
 206. Imamuddin, p. 153.
 207. Lacroix, *Science and Literature In The Middle Ages and The Renaissance*, p. 122.
 208. James Joseph Walsh, *High Points of Medieval Culture* (Freeport N.Y.: Books for Libraries Press, 1969), p. 89. [also cited in Rashdall's text vol I, p. 81].
 209. Haskins, *Studies In The History of Medieval Science*, p. 4-5 [also cited in Gabriel Compayre's *Abelard and The Origin and Early History of Universities* (N.Y.: Scribner's Sons, 1893), p. 244].
 210. Walsh, *High Points of Medieval Culture*, p. 89.
 211. Monroe, *Islam and the Arabs in Spanish Scholarship*, p. 41.
 212. Lacroix, *Science and Literature In The Middle Ages and The Renaissance*, p. 168.
 213. Monroe, p. 4.
 214. Chejne, *Muslim Spain*, p. 287.
 215. Haskins, *Studies In The History of Medieval Science*, p. 243.
 216. Chejne, p. 287.
 217. Haskins, p. 244.
 218. *Ibid*, p. 260.
 219. Chejne, *Muslim Spain*, p. 403.
 220. Rashdall, *The Universities of Europe In The Middle Ages vol I*, p. 250-1.
 221. Proctor, *Alfonso X of Castile*, p. 130.
 222. Haskins, *Studies In The History of Medieval Science*, p. 249.
 223. Rashdall, *The Universities of Europe In The Middle Ages vol I*, p. 82-3.
 224. Haskins, p. 250.
 225. *Ibid*, p. 5.
 226. *Ibid*, p. 270-1.
 227. Lacroix, *Science and Literature In The Middle Ages and the Renaissance*, p. 10-11.
 228. Rashdall, vol II, p. 127.
 229. O'Callaghan, *A History of Medieval Spain*, p. 500.

230. Rashdall vol II, p. 120.
 231. Lacroix, *Science and Literature In The Middle Ages and The Renaissance*, p. 166-7.
 232. Rashdall vol II, p. 120.
 233. McCabe, *The Moorish Civilization In Spain*, p. 11.
 234. Rashdall vol I, p. 295.
 235. *Ibid*, p. 121.
 236. *Ibid*, vol II, p. 138-9.
 237. Vallicrosa, *Las traducciones orientales en los manuscritos de la Biblioteca Catedral de Toledo*, p. 7-8.
 238. Rashdall vol I, p. 436.
 239. Lacroix, *Science and Literature In The Middle Ages and The Renaissance*, p. 32.
 240. Rashdall vol III, p. 13.
 241. *Ibid*, p. 238.
 242. Haskins, *Anniversary Essays In Medieval History* (Freeport N.Y.: Books For Libraries Press, 1969), p. 268.
 243. Rashdall vol III, p. 248.
 244. Haskins, *Studies In The History of Medieval Science*, p. 3.
 245. Rashdall vol I, p. 35.
 246. Chejne, *Muslim Spain*, p. 401.
 247. Rashdall vol I, p. 27.
 248. Walsh, *High Points of Medieval Culture*, p. 203.
 249. Monroe, *Islam And The Arabs In Spanish Scholarship*, p. 179.
 250. *Ibid*.
 251. Lacroix, *Science and Literature In The Middle Ages and The Renaissance*, p. 87.
 252. *Ibid*, p. 204.
 253. Rashdall vol III, p. 246.
 254. Lacroix, p. 199.
 255. McCabe, *The Splendours of Moorish Spain*, p. 244.
 256. Rashdall vol III, p. 247.
 257. Haskins, *Studies In The History of Medieval Science*, p. 33-34.
 258. Jan Read, *The Moors in Spain and Portugal* (London: Faber and Faber, 1974), p. 176.
 259. Haskins, p. 37.
 260. *Ibid*, p. 41.
 261. Monroe, *Islam And The Arabs In Spanish Scholarship*, p. 13.

Bibliography

Primary Sources:

- Rodríguez, Jose' ed. *Memorial Historico Espanol: Coleccion De Documentos, Opusculos y Antiquedades, Que Publica La Real Academia De La Historia Tomo I*. Madrid: Imprenta De La Real Academia De La Historia, 1851.
 Smith, Colin ed. *Christians and Moors In Spain vol I*. Warminster Eng: Aris & Phillips Ltd., 1988.
 Vallicrosa, Jose' M. Millas ed. *Las traducciones orientales en los manuscritos de la Biblioteca Catedral de Toledo*. Madrid: Consejo Superior De Investigaciones Cientificas Instituto Arias Montano, 1942.

Vazquez De Parga, Luiz ed. *Textos Historicos En Latin Medieval Siglos VIII—XIII*. vol 23. Madrid: Escuela De Estudios Medievales C.S.I.C., Comision De Latin Medieval, 1952.

Secondary Sources:

- Ahmad, S.S. *The Moorish Spain*. Karachi Pakistan: Farooq Kitab Ghar Publishers, 1972.
- Avey, Albert E. *Handbook In The History of Philosophy: A Chronological Survey of Western Thought 3500 B.C. To The Present*. N.Y.: Barnes & Noble, 1961.
- Bernal, Martin. *Black Athena: The Afroasiatic Roots of Classical Civilization* vol I. New Brunswick, N.J.: Rutgers University Press, 1987.
- Bovill, E.W. *The Golden Trade of The Moors*. London: Oxford University Press, 1968.
- Brace, Richard M. *Morocco, Algeria, Tunisia*. Englewood Cliffs N.J.: Prentice-Hall Inc., 1964.
- Bradley, Michael. *The Iceman Inheritance: Prehistoric Sources of Western Man's Racism, Sexism and Aggression*. N.Y.: Warner Books, 1978.
- Burckhardt, Titus. *Moorish Culture In Spain*. Translated by Alisa Jaffa. N.Y.: McGraw-Hill Book Co., 1972.
- Burns, Robert Ignatius. *Moors and Crusaders In Mediterranean Spain: Collected Studies*. London: Variorum Reprints, 1978.
- Chejne, Anwar. *Muslim Spain: Its History and Culture*. Minneapolis: The University of Minnesota Press, 1974.
- Compayre, Gabriel. *Abelard and The Origin and Early History of Universities*. N.Y.: Scribner's Sons, 1893.
- Coppee, Henry. *History of the Conquest of Spain By The Arab-Moors vols I & II*. Boston: Little, Brown & Co., 1881.
- Diop, Cheikh Anta. *The African Origin of Civilization*. Translated by Mercer Cook. Westport Conn: Lawrence Hill & Co., 1974.
- Fairbairn, James. *Fairbairn's Crests of The Families of Great Britain and Ireland*. (Revised by Laurence Butters) Rutland, Vermont: Charles E. Tuttle Co., 1968.
- Fox-Davies, Charles A. *The Art of Heraldry: An Encyclopaedia of Armory*. N.Y.: Benjamin Blom Inc., 1968.
- Ganshof, Francois L. *The Middle Ages: A History of International Relations*. Translated by Remy Ingles Hall. N.Y.: Harper & Row, 1970.
- Haskins, Charles Homer. *Anniversary Essays In Medieval History*. Freeport, N.Y.: Books For Libraries Press Inc., 1969.
- . *Studies In The History of Medieval Science*. N.Y.: Frederick Ungar Publ., 1960.
- Imamuddin, S.S. *Some Aspects of The Socio-Economic and Cultural History of Muslim Spain 711-1492*. Leiden: E.J. Brill, 1965.
- James, George G.M. *Stolen Legacy*. London: The African Publication Society, 1972.
- Lacroix, Paul. *Science and Literature In The Middle Ages and The Renaissance*. N.Y.: Frederick Ungar Publ., 1964.
- Lewis, Benjamin. *The Muslim Discovery of Europe*. N.Y.: W.W. Norton & Co., 1982.
- McCabe, Joseph. *The Moorish Civilization In Spain*. Girard Kan.: Haldemar-Julius Co., 1927.
- . *The Splendour of Moorish Spain*. London: Watts & Co., 1935.
- McLaughlin, Terence. *Dirt: A Social History As Seen Through The Uses And Abuses of Dirt*. N.Y.: Dorset Press, 1971.
- Monroe, James. *Islam and The Arabs In Spanish Scholarship*. Leiden: E.J. Brill, 1970.

- O'Callaghan, Joseph F. *A History of Medieval Spain*. Ithaca: Cornell University Press, 1975.
- O'Leary, De Lacy. *Arabic Thought And Its Place In Western History*. London: Kegan Paul, Trench, Trubner & Co., 1922.
- Proctor, Evelyn S. *Alfonso X of Castile*. Westport, Conn: Greenwood Press, 1980.
- Rahman, Fazhur. *Health and Medicine In The Islamic Tradition: Change and Identity*. N.Y.: Crossroad Publications, 1987.
- Rashdall, Hastings. *The Universities of Europe In The Middle Ages vols I, II & III*. London: Oxford University Press, 1958.
- Read, Jan. *The Moors In Spain and Portugal*. London: Faber and Faber, 1974.
- Rogers, J.A. *Sex and Race vol I*. St. Petersburg Fl: Helga M. Rogers, 1967.
- . *Nature Knows No Color-Line*. St. Petersburg Fl: Helga M. Rogers, 1952.
- Sordo, Enrique. *Moorish Spain*. N.Y.: Crown Publishers, 1963.
- Van Sertima, Ivan ed. *African Presence In Early Europe*. New Brunswick N.J.: Transaction Books, 1985.
- Vives, Jaime Vicens. *Approaches To The History of Spain*. Translated by Joan Connelly Ullman. Berkeley: University of California Press, 1970.
- Walsh, James Joseph. *High Points of Medieval Culture*. Freeport N.Y.: Books For Libraries Press, 1969.
- Diccionario De Lengua Espanola: Vegesima Edicion Tomo II*. Madrid: Real Academia Espanola, 1984.

Journals:

- Udayar, S.M. "Sri Lanka Moor Physicians (Hakeems) To The Sinhala Kings," *Moor's Islamic Cultural Home Souvenir IV* (1977-1982) p. 171. Colombo 1, Sri Lanka: Mohinudeen Hamzah, 1983.
- Vallicrosa, Jose M. Millas. "La Corriente De Las Traducciones Cientificas De Origin Hasta Fines Del Siglo XIII." *Journal of World History* vol 2. (1954-55): 395-428.

Papers:

- Welsing, Frances Cress. "The Cress Theory of Color Confrontation and Racism (White Supremacy)," Wash D.C.: C-R Publ., 1970.
- Lotfi, Aziz. "Afrocentricity And The Berber-Arabo-Muslim Heritage of North Africa." Unpublished Paper/Dept. of African-American Studies. Temple University/ AAS 400, Fall 1990.

Miscellaneous:

- Shakespeare, William. *Othello*. David Bevington editor. Bantam Books, Printed 1988.

MOORISH CULTURE-BRINGERS: BEARERS OF ENLIGHTENMENT

Jan Carew

Literature does not die unless its creators become the victims of genocide and silence of the grave, and until its creations are erased from the mind's ear and the mind's eye and calcined in bonfires. At the beginning of the Columbian Era, thousands of books that the Moors had collected over centuries—priceless masterpieces that their geographers, scientists, poets, historians and philosophers had written, and tomes their scholars had translated—were committed to bonfires by Priests of the Holy Inquisition. And to cap this atrocity, an estimated three million Moors would eventually be expelled from Spain or forced to convert to Catholicism. The burning of thousands of books and the expulsion of the Moors was a terrible loss to the Renaissance, which is seldom acknowledged by Eurocentric historians and scholars. And the glaring irony is that the Renaissance would not have been possible without the seminal cultural infusions of Moorish scholarship.

The Fall of Granada on January 2, 1492, marked the end of eight hundred years of Moorish suzerainty on the Iberian Peninsula. "According to tradition, the valiant General Musa denounced the surrender to the last and rode out of the Elvira Gate never to reappear."¹ And, on January 6, four days after the formal surrender, Ferdinand of Aragon and Isabella of Castile rode into the citadel and took the keys of the Alhambra, that marvel of Moorish architecture. Jan Read who understood the Moorish culture better than most of her blinkered Eurocentric peers describes it thus:

Together with the hanging gardens of the Generalife above, it is perhaps the most successful fusion of architecture and landscape ever achieved by man

... Perhaps we can leave the last word to the Emperor Charles V as he looked out from a balcony of the Hall of the Ambassadors to the heights of the Albaicin opposite and the smiling *vega* with its groves and gardens far below. 'Ill-fated,' he exclaimed, 'is the man who lost all this!'²

The young Caliph, Abu 'Abdi-Llah ("Boabdil" to the Spaniards), handed over the keys to the Spanish sovereigns and so, the *Reconquista* came to a dramatic end. Along with the keys to the citadel came priceless tomes and manuscripts which would be scattered and committed to the flames. Boabdil had surrendered this last Moorish outpost without a fight and his dark-skinned

mother, 'A'isha, had reproached him bitterly, saying, "Weep like a woman for what you could not defend like a man."³

Under the terms of capitulation, the conquered Moors would retain their own customs and religious freedoms and would be held accountable only to their own judges ... [and] Christian women married to Moors and others who had converted to Islam from Christianity would not be reconverted against their will.⁴

However, a decade later, Queen Isabella of Castile, whose religious zealotry and greed for confiscated Moorish and Jewish property, outstripped that of her husband, abrogated this agreement. It was Isabella, too, who appointed the infamous Spanish Dominican, Tomas de Torquemada as inquisitor-general. She also signed the edict ordering the expulsion of Jews on March 31, 1492. From the moment the ink had dried on that order, the fate of the Moors was also sealed. It would only be a matter of time before their turn came to be forcibly expelled. And it did come ten years later. This precedent established a tradition of treachery and racism that was adopted by all of the European colonizers who came in the wake of the Spanish, and it would endure throughout the Columbian era.

The thousands of volumes committed to the flames by officials and agents of the Holy Inquisition, embodied the best of Islamic and Hellenistic learning which had been fed from its earliest beginnings by roots buried deep in the creative soil of Africa. Compared to the Christian principalities, like Galicia, Leon, Castile and Navarre, the Moorish-dominated al-Andalus was a region of unbelievable enlightenment. At a time when the most insignificant provinces of Moorish Spain contained libraries running into thousands of volumes, the cathedrals, monasteries and palaces of Leon, under Christian rule, numbered books only by the dozen. Unlike their Christian counterparts, Moorish rulers, "were often philosophers, mathematicians or poets [and] ... at a period when [historian] Ibn-Hayyan of Cordoba could write a history of Spain in ten volumes, lively, detailed and well-observed, all that eleventh century Leon could offer were the fifteen sparse and imprecise pages of Sampiro, notary to Alfonso V."⁵ In fact, the paltry number of texts the Christians did possess were almost all devotional or liturgical.⁶ It was little wonder then, that in 1492, "less than twenty years after the introduction of printing to Spain, Elio Antonio de Nebrija, historiographer royal to Queen Isabella, published in Salamanca a grammar of the Castilian language, the first such work ever compiled for a European vernacular

"What is this for?" Isabella is said to have asked ... when Nebrija's book was presented to her by a royal courtier, "Your Majesty," the courtier is reported to have answered, "Language is always the companion of empire."⁷

But the Moors had already known this for centuries. Arabic grammars had had to be created so that language could be the companion of an Islamic empire stretching across three continents.⁸

On October 12, 1492, nine months after the Fall of Granada, Columbus landed on the beaches of the Taino island of Guanahani. Thus, Spain claimed that it had discovered a 'new world,' and it embarked upon a shameful course of genocide against indigenous peoples of the Americas that made their atrocities against the conquered Moors pale by comparison.

Coming to the Iberian Peninsula in the wake of the Vandals and Visigoths, the Moors had, over their long tenure, civilized the land they called "al-Andalus," a name which derived from the former designation of the Iberian peninsula as the "Land of the Vandals". But once the *Reconquista* had ended, a unified Spain seemed bent on moving backwards into the future. With the end of Moorish power, the Spanish not only went on a book-burning spree, they also tried to erase every vestige of Moorish cultural influence from their consciousness. The Holy Inquisition with its *limpieza de sangre* (cleansing of the [Spanish] blood), its zealotry, and its all-encompassing and repressive tentacles reaching into the lives of the highest and lowliest in the land, set about de-civilizing the Iberian Peninsula. And the persecution was most wrenching in the lives of Spain's principal culture-bringers: the Moors and the Jews. But the Moors, who were more numerous and who were expelled later than the Jews, resisted long after the fall of Granada.

In 1568 a second and even more violent rebellion broke out in the Alpujarras. Its leader Fernando de Valor (Maulvi 'Abd-Allah Mohammad ibn-Umayya), justified his action by declaring, 'We are in Spain and we have ruled this land for nine hundred years We are no band of thieves but a kingdom; nor is Spain less abandoned to vices than was Rome.'⁹

This particular rebellion was so serious that Phillip II had to call on help from Don Juan of Austria to put it down.

But when one talks about Moors and Jews in the context of that transitional period between the rise of Spanish power and the final defeat of the former and the expulsion of both, one must bear in mind that neither the terms "Moor" nor "Jew" referred to a uniform racial type. They were both the products of polyglot racial mixtures in North Africa and Spain, and only their cultural and religious trappings would have enabled an outsider to distinguish one from the other.

During their long tenure as rulers, "the Moors ... had set a pattern of peaceful symbiosis in their tolerant treatment of Christians and Jews; and a new class analogous to the *Mozarebs* [Christians under Muslim rule] was to appear: the *Mudejars*, or Muslims living under Christian rule."¹⁰

For centuries, Muslims, Christians and Jews had lived side-by-side, and in many instances had so intermarried that numerous families were part Muslim, part Christian and part Jew. The teachings of the Prophet, too, had stressed repeatedly that peoples of all races and colors were equal in the sight of Allah, and these teachings were not only preached but often practiced.

The persecution of Moors and Jews, therefore, and their tragic and inhuman expulsion, gave added momentum to the institutionalization of racism in Christian Spain after the *Reconquista*. And this peculiarly European phenomenon of a manicheistic racism, (white against black and brown), wove itself into the fabric of Christianity and remains embedded there to this day.

At its zenith, Muslim power stretched from China, across the Himalayas into India, through the Middle East, and deep into the Nile Valley. It criss-crossed all of North Africa, reached down to Dar-es-Salaam in East Africa and went as far south as Ghana in West Africa. And it then spread north across the Pillars of Hercules to stretch from Portugal's Atlantic coast, through the Iberian Peninsula, over the Pyrenees and into France's Rhone Valley and beyond.

This vast and complex Islamic geo-political, cultural and racial spread is almost invariably viewed through a spectrum of religious intolerance and racial chauvinism by Eurocentric scholars. Even the words used to describe other peoples, their religion and their culture underscore a continual struggle by Europe to come to terms with their biased racial perceptions. Words, such as: "Islam" and "islamic", or "Muslim"(noun) and "muslim"(adjective) have been thrown about without a sense of their particular contextual significance. "Islam," the noun, refers to the religion begun by Muhammad in the 7th century. "Islamic," the adjective, refers to the particular character of the religion, which then reflects on the noun that follows, as in "Islamic calendar." "Muslim," the noun, refers to a person who is an adherent of Islam, and "muslim" the adjective which derives from the noun, refers to the particular character of a Muslim, and variously, to the civilization of Islam. The distinction between the two is now blurred.

The terms "Arab," "Berber," "Moor," and "Tuareg," have also undergone several permutations. "Arab" originally referred to an inhabitant of the Arabian peninsula who spoke Arabic. But, recent research has pointed to the fact that "Arabia was the oldest Ethiopian colony ...," that "the Cushites were the original Arabians ... [and that] Ancient literature assigns their first settlement to the extreme southwestern point of the peninsula. From thence they spread northward and eastward over Yemen, Hadramaut and Oman."¹¹

When the "Arabs," therefore, began to spread westwards into Egypt and across the Red Sea, they were largely absorbed into the black and brown gene pools of the peoples of the Nile, the Sahara and the northern Mediterranean and Middle Eastern colonies scattered across the northern rim of Africa. As W.E.B. Du Bois pointed out, "The term Arab is applied to any people professing Islam, ... much race mixing has occurred so that while the term has a cultural value it is of little ethnic significance and is often misleading."¹²

Furthermore, not all Arabs were or are Muslims, although it is likely that those with whom Europe dealt in the period of the Muslim presence in Spain were. On the other hand, most "Moors," that is persons originating in Morocco,

and "Berbers", again a very imprecise term referring to polyglot Saharan white, black and brown North African groups of largely nomadic people, were officially classified as Muslims. They were converted to Islam in the sweep of the religion across northern Africa between 640 and 700. And while they had some Arab admixture after their long period of cohabitation, they were primarily African. Arabs, Berbers, Tuaregs and Moors of every possible shade and color were present in that invading army that conquered Spain, but it was the Moors, who, coming in successive waves for eight centuries, left a permanent imprint upon the Spanish language and culture in particular, and European civilization in general.

For European scholars, the historical mileposts in Europe's relationship with the Arabs, the Saracens and the Moors were the Crusades, the Fall of Constantinople to the Turks and the Fall of Granada to the Catholic rulers of Spain. These events are locked in a time-warp which, in turn, has created a tunnel vision of history with a demonized image of the Muslim as an infidel and a perpetual enemy of the 'devout' Christian. And in this racist mythology, even bandits like el Cid are practically deified as Soldiers of the Cross fighting against Muslim 'barbarians.' We are not told that after his string of victories (as a clever Field Commander, he had devised effective methods for overcoming the advantage of the Almoravid's massed infantry), he time and time again joined forces with Muslim groups opposed to the Almoravids. In the wake of el Cid's premature death, however, the Almoravids reconquered the whole of southern Spain and Portugal and inflicted a crushing defeat on Alfonso VI, his erstwhile mentor. Thus, the victories of this legendary Spanish hero who had fought, first as a mercenary and then as a usurper, were brought to naught by Moorish conquerors. Spanish and other European historians have, over the centuries, developed a case of amnesia when dealing with this sequel to el Cid's victories.

At the same time, however, some Arab/Islamic scholars, while deriding the narrow focus of the Eurocentric tunnel vision, and the implicit racism built into it against them, become racists themselves when dealing with Black Africans. In addition to the reprehensible role they played in the Slave Trade, they have developed a myopic and chauvinistic vision of their role in history and cling to Greek and Middle Eastern civilizations while ignoring the tremendous contribution that Africa made to Islamic civilization.

When the Prophet Muhammad fled to Medina, some of his most devoted followers crossed the Red Sea and began to proselyte in Ethiopia. So, the first significant groups of the converted were Africans. The Muslim religion, therefore, was filtered through the great African civilizations of the Nile Valley—the Ethiopian, the Nubian and the Egyptian—in its early stages. These ancient civilizations provided Islam with an intellectual, cultural and spiritual nexus from which its message and its innermost content would be immeasurably humanized and enriched.

Four centuries after Islam had taken root in Africa, and the Islamic empire was at its zenith, the Almoravids, a Sanhaja extension of the Tuareg people,¹³ carried Islamic/Moorish culture victoriously into Europe in 1086, "giving new life to Muslim al-Andalus."¹⁴ In fact, the predominantly midnight-black Almoravids, as relatively new converts to Islam, were the most ardent in demanding that those in authority should once more seek to abide by the tenets of morality and justice that were laid down in the *Holy Koran*. And these new devotees (the Almoravids), at first intolerant of the urbane and decadent intellectuals and scholars in the cities they conquered, were eventually corrupted by these very intellectuals. The pristine energy of the Almoravids, however, did manage to impregnate Moorish literature, art, music and philosophy with new rhythms of life and a heightened sense of being. Their musicians, storytellers, griots and catechists popularized their religious and cultural message with a fervor that the original Moorish conquerors had lost. And they did this by reaching into the reservoir of African oral traditions which were so ancient, that seers and griots had declared that these primordial traditions had first come to them 'from the breath of God.'

Biased historians, however, tend to portray the Almoravids (the dark Moors) as bigots, while uncouth European marauders like the Crusaders, waving Christian banners across the Iberian peninsula and through the Middle East, are depicted as pious Soldiers of Christ. There is an instinctive and deep-seated reluctance on the part of Eurocentric historians to acknowledge the Moors as the bringers of cultural and scientific enlightenment to Europe. And when they are compelled to make grudging acknowledgements of this fact, they proceed to whiten the Moors, to tear them away from any suggestion of having black African roots. But the stubborn fact remains that at the height of its power the Moorish Empire in Africa stretched from the western half of Algeria through Morocco and as far south as Ghana; while in Europe this empire extended itself from the Atlantic coast of Portugal, through Spain and across the Pyrenees to the Rhone Valley in France. And now, five centuries after the Fall of Granada, the rainbow array of colors and racial types that one sees in the faces of the contemporary population of this region—from blond and blue-eyed, through various shades of brown to black—is not all that different to what it was in the Moorish Empire in the 11th century despite new genetic infusions by migrants and successive waves of settlers.

Is it any wonder then, that scholars, blinkered by their racism, have difficulty acknowledging who the Almoravids (1056–1147) really were; or that they continue to describe them variously as: "descended from the Sanhaja tribes [sic] of the Sahara;"¹⁵ or "the desert Sanhaja from whom the Almoravids had first drawn support,"¹⁶ suggesting the Almoravids, themselves, were something else and that they got the Sanhaja to help in their campaign; or "the African troops, the Sinhaja,"¹⁷ or a "powerful Berber Sanhajah tribe [sic]."¹⁸ Eurocentric historians continue to produce learned treatises on 'fierce' and

'warlike' Saharan tribes like the Sahajas, Berbers, Tuaregs etc. — 'fierce' and 'warlike' being euphemisms for 'simple-minded and blood-thirsty.' Somehow, the most blood-thirsty and murderous of European adventurers are never described as being 'fierce' or 'warlike.'

Evidence of the Moors' civilizing mission are strewn across the Iberian Peninsula. It is, in fact, because of the Moorish conquest and the Moorish civilizing mission that the factional European tribes and kingdoms were able to direct their energies from fighting amongst themselves to studying the very philosophies and sciences that would propel them out of their insular perspectives into uncharted seas and across new continents of the imagination.

Although there were many instances wherein some prized Arabic texts were translated into Latin and/or Romance languages and the originals destroyed, Christian Spain carried out a systematic anti-Moorish program after the *Reconquista*. Though benefitting greatly from the scientific, the philosophical, and the literary innovations brought to them by the Moors, the Spanish and other Europeans systematically wiped out any and all reference to the great influence the Moors had on their subsequent development. Nowhere was this more evident than in the literature of post-Moorish Europe.

The Arabs brought the works of Dynastic Egyptian and Classical Greek back to Europe by translating into Arabic the Greek translations of the Egyptian texts as well as the works of the Greek thinkers themselves, synthesizing and improving upon them. Unlike Christian theologians who forbade scholars from considering ideas outside of the prescribed ecclesiastical canons of the day (Galileo fell afoul of these restrictions), Islam accommodated new ideas with grace and a civilized tolerance.

Muslim scholars had found a particular fascination in the philosophy and science of the early Greeks, (not realizing their debt to the Egyptians) and after translating the texts of Aristotle, Plato, Ptolemy, Euclid, Heracleitus, Galen, Hippocrates and others, they analyzed and improved upon them, drawing from their wide-ranging intellectual experiences and observations in the vast territories they ruled, and the polyglot races and peoples with whom they traded in knowledge, ideas and goods. Muslim scholars absorbed, synthesized and expanded upon the knowledge of the Ethiopians and Egyptians, the Phoenicians, the Greeks, the Chinese, and the Indians. A new and momentous forward leap in the theoretical and applied sciences evidenced itself in Moorish mathematics, medicine, astronomy, navigation, and new concepts of world geography and philosophy. The popularity of Moorish scholarship was such, that for centuries Arabic was commonly accepted as the language of scholars from Europe, Asia and Africa, and the Moorish intellectual centers in Toledo, Cordova, Seville and Granada became Meccas of learning. For centuries, too, the rulers of Europe and their wealthiest courtiers and merchant princes, relied on Moorish physicians and surgeons to cure them of their various ailments. And they judged those roving medical specialists by their

skills and not their color. Even after the *Reconquista* (the wresting of Spain from its Moorish conquerors), Christian rulers continued surreptitiously to invite Moorish scholars to their kingdoms, because of a profound respect for their knowledge and expertise.

Moorish scientific and organizational abilities transformed their cities into extraordinarily advanced urban centers. Not only were their public and private buildings aesthetically pleasing but their architects and planners created cities the likes of which had never been seen before in Europe. Some historians assert that the Moors of Spain, unlike their nomadic kith and kin from the desert kingdoms, were essentially an urban people. But this statement is only a half-truth and needs to be qualified, for cities require a countryside capable of feeding large populations.

The Moors had been able to create a harmony in the rhythms of life in the city and in the countryside. They dotted the map of al-Andalus with their cities and towns, but they could only do this because the surrounding countryside was kept fertile and productive — with advanced drainage and irrigation systems, reservoirs, aqueducts, sophisticated storage facilities and efficient marketing, transportation and trading networks. The Moors also brought the countryside into their cities with fantastic gardens, parks, lush inner courtyards and a constant supply of pure water. The gardens in Moorish cities, both public and private ones, were known as "paradises," a fitting term with which to describe those exquisite botanical marvels.

Different Moorish cities came to be known for their particular forte: Cordova — its libraries and collections; Seville — its music and musical instruments; Toledo — a center of industry and learning; but all shared a common feature of highly sophisticated urban management and unbroken and seminal connections with the land. Moorish cities were noted for their public hospitals, public baths, lighted thoroughfares, hot and cold running water, magnificent religious monuments, the grandeur of their mosques, gardens with exotic plants and even more exotic birds, and beautifully designed fountains. (See figure 1.)

Ibn Khaldun (1332–1406), published a 7-volume history of the world in 1284, entitled *The Book of Examples and Collections from the Early and Subsequent Information Concerning the Days of Arabs, Non-Arabs, and Berbers*.¹⁹ Ibn Khaldun was the first to develop the theory of the cyclical development of society wherein a given society flourishes for a time and then declines under the weight of the pomp, luxury and growing inefficiency. It was Ibn Khaldun who suggested that "the ideal framework for Islamic life is a holy city with a nomadic periphery, with the city representing the stronghold of learning and meditation and the nomadic hinterland guaranteeing the constant influx of fresh elements [people unspoiled by urban culture]."²⁰ In addition to being a historian, Ibn Khaldun became one of the fathers of the sciences of economics, anthropology, political science, and urban planning,

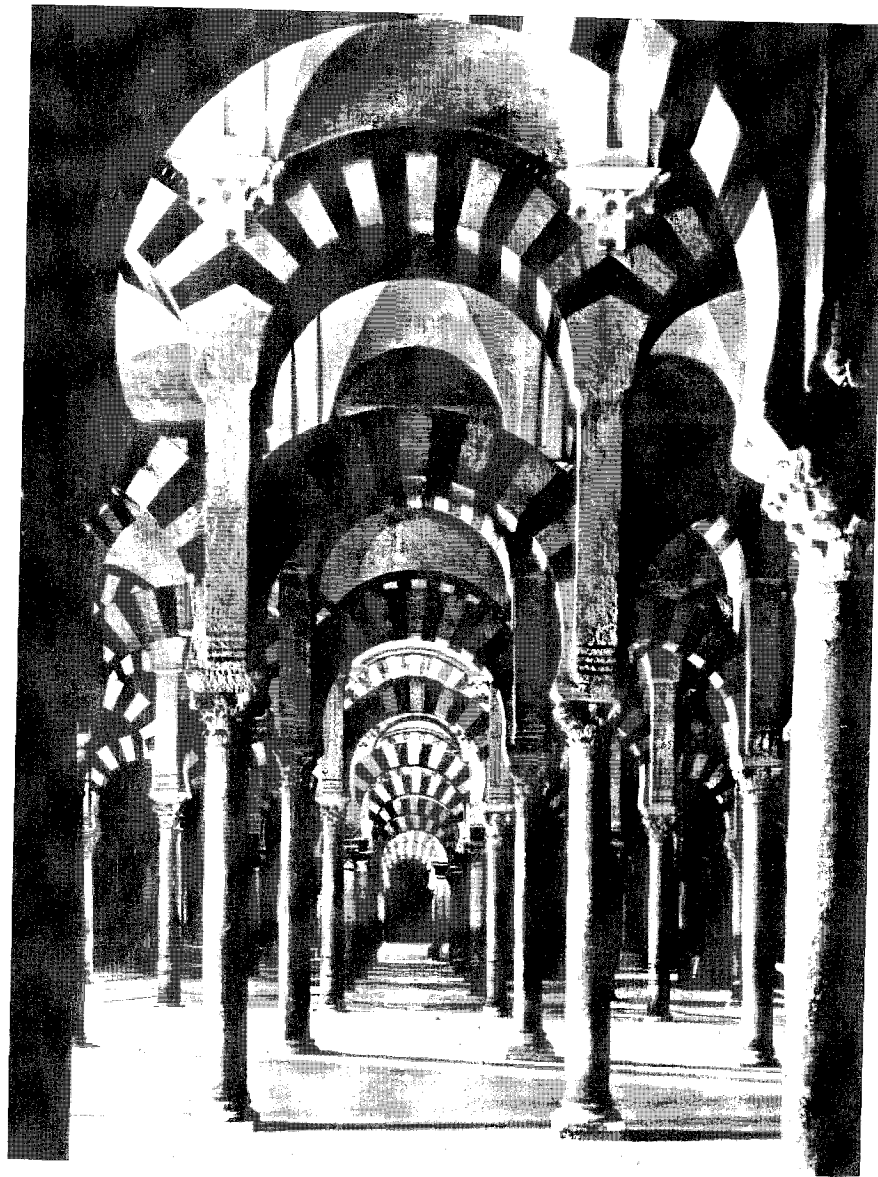

Figure 1. The Mosque of Cordova; red and white naves built by Abd al-Rahman I, 8th century (Source: *Muslim Spain; Its History and Culture*, (Chejne, p. 272a).

and his erudition was such that up to the present time, his birthday is celebrated by Islamic and non-Islamic scholars all over the world. In his lucid and persuasive writings, he formulated systems of city planning and dealt with problems of "air pollution, physical layout, zoning, education, and city support for arts and sciences...."²¹

Moorish sanitary engineers, city planners, doctors and public health officials understood that high public health standards could only be achieved when there was an educated and responsible citizenry. A great deal of attention, therefore, was paid to inculcating the idea that effective public health began with good individual habits of personal hygiene by rich and poor alike. The smallest Moorish villages, hamlets and towns had public baths. As the *Reconquista* progressed, however, benighted Catholic priests had the public baths closed and the faithful were told that daily ablutions were sinful. In 1568, Phillip "banned public baths until then found in the smallest of Moorish towns and villages..." [thus] "...delivering a body blow to Muslim tradition."²²

A succession of plagues and famines fell upon both the Spanish cities and countryside as the *Reconquista* progressed and the Moors were driven out. The countryside was then devastated by hidalgos and martial peasants, agricultural lands were denuded of food products and vast acreages were reserved for sheep and cattle rearing or left idle and uncultivated. The plagues that savaged Spanish and other European cities in the century after Columbus' First Voyage were given ample opportunity to go on the rampage amongst populations encouraged by their prelates to live by the adage that 'filthiness is next to godliness.' Paradoxically, European historians blame these plagues on the syphilis that Spanish males allegedly caught from 'Indian' women. But blaming the victim, especially when ethnocide has ensured that the victim cannot speak back, is an intellectually dishonest pastime in which Eurocentric historians have indulged for centuries. As Richard Ford, a perceptive scholar tells us "Ablution and lustral purification formed an article of faith with the Jew and Moslem, with whom 'cleanliness is godliness' Ximenez, [who afterwards became a Cardinal] ... a shirtless Franciscan, induced Ferdinand and Isabella, at the conquest of Granada, to close and abolish the Moorish baths [and] Fire, not water, became the grand element of inquisitorial purification."²³

Even their most implacable Spanish enemies acknowledged that the Moors were superb agricultural scientists, for they had cultivated not only the fertile areas, but had brought the arts of 'dry farming' to the high, bleak mesas; reconstructed and improved the old Roman irrigation systems and introduced a variety of new crops like cereals, beans and peas of various types, olives, almonds, and vines—invaluable sources of protein and other indispensable nutrients. Here, for example, is an entry made by a Moorish official in the month of March 961.

Fig trees are grafted in the manner called Tarqi'; the winter corn grows up; and most of the fig trees break into leaf ... the falcons of Valencia lay eggs ... Sugar cane is planted. The first roses and lilies appear. In kitchen gardens, the beans begin to shoot.²⁴

Other crops introduced by the Moors included a variety of herbs, the orange (which was first grown in Valencia, hence the term *Valencia orange*) pomegranates, bananas, coconuts, maize and rice. Here, for example, is a poem by Mahbub the Grammarian, an 11th century poet, eulogizing a great water wheel in motion. These water wheels, which were introduced by the Moors, were invaluable sources of energy for irrigation, the grinding of grain, etc. (See figure 2.)

*She sobs and weeps her streams of sparkling water,
She weeps, and the garden smiles with many a petal
Of deepest red, of white and brilliant yellow;
You'd say the smith made scoops of pearl, and not of metal.*²⁵

The Moors had a respect for Nature that bordered on idolatry, while the Spanish felt that Nature was impregnated with hidden antagonistic forces that had to be conquered and exploited. The cosmology which conceived of Nature and all natural forces as being "threatening" was an intrinsic part of the Church's teachings. Forests were invariably depicted as being dark and menacing, the home of wild beasts and evil spirits. Conversely, in the Moorish cosmology, the forest was a place of light and enchantment. As the *Reconquista* progressed, the Moorish love and respect for their environment was increasingly depicted by their Spanish conquerors as evidence of their being heretics, pagans and infidels. Centuries later, Garcia Lorca resurrected the creative vision of the Moors and gypsies of Andalusia in his poetry and plays. When he wrote about the 'forests of my flesh,' he showed a profound understanding of the forgotten Moorish belief that forests were, in fact, the 'lungs' of the earth.

At the zenith of Moorish power, al-Andalus, that land of many cities, attracted scholars from England, France, Germany, Italy, the rest of Europe, as well as from distant parts of the Muslim empire. After the Mongol conquests, too, al-Andalus benefitted from the intellectual cross-fertilization of Muslim scholars fleeing from the wrath of Ghengis Khan and his descendants.

Many of the European scholars came to learn Arabic so that they could read and popularize the knowledge acquired in Moorish centers of learning amongst their own relatively backward people. The Moorish city of Toledo, which was reconquered in 1085, became a cornucopia of newly discovered learning for a benighted population of Europe beyond the Pyrenees, and Christian rulers, from Alphonso VII (1126–1157) onward encouraged the establishment of schools of translation and of Arabic/Oriental studies in order to ensure a steady flow of new scholarship into their kingdoms.

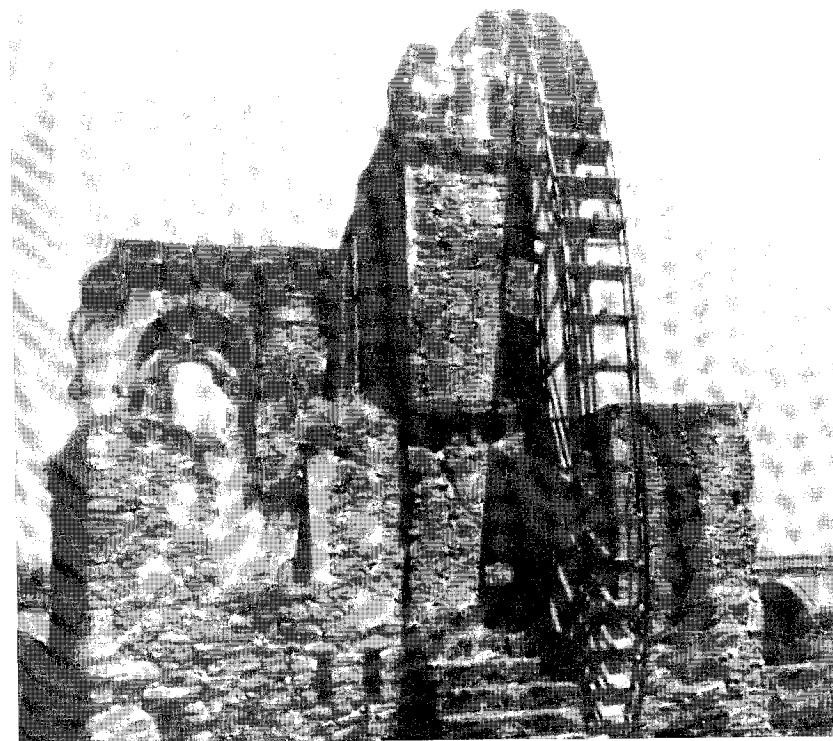
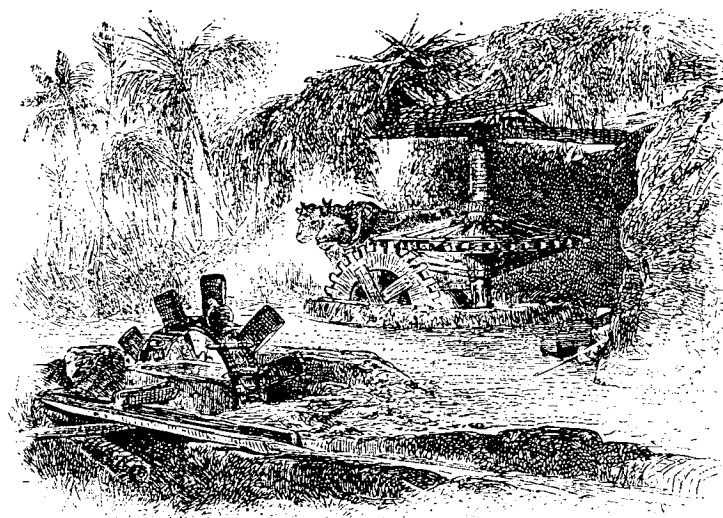

Figure 2a and 2b. Moorish water wheels (or noria).

It is intriguing that on the one hand there have been the racist and bigoted religious slanders directed at the Moors after the Fall of Granada in 1492. While on the other hand, there was the insatiable appetite of European scholars for Arabic works in mathematics, astronomy, physics, alchemy, natural sciences, and philosophy, not to speak of literature and music. Both Thomas Aquinas (1225–1274) and Dante (1265–1321), for example, were virulently anti-Islam and anti-Arab. Aquinas, however, constantly referred to Arab scholars and Arab thought with a profound respect, and Dante choose to put Muslim scholars, such as Salah al-Din, Ibn Sina (Avicenna) and Ibn Rushd (Averroes), among the great thinkers of antiquity in his *Divine Comedy*.²⁶

The great Arab philosopher Ibn Rushd (known as “Averroes” in Europe) had perhaps the most widely acknowledged and profound effect on Western thought. Born and reared in Cordova in 1126 at the time of the Almoravids (the dark-skinned, Saharan Moors) Averroes was best known for his translations of Aristotle. His name became so closely linked with Aristotilian philosophy that whole schools of philosophy were set up in Paris, Padua and Bologna to spread “Averroism.”²⁷ Besides philosophy, he was also extremely influential as a purveyor of new medical knowledge. In fact, Averroes was a renaissance scholar long before the Renaissance: he was a poet, scientist, philosopher, historian and mathematician. (See figure 3.)

But Averroes might very well have lived and died in obscurity if it were not for two fortuitous circumstances: the patronage of the enlightened Moorish ruler Abu Ya'qub Yusuf and the enthusiastic support of the Spanish Jewish philosopher Musa Ibn Maymun (1135–1204)(also known as Maimonides).²⁸ Thanks to Abu Ya'qub Yusuf, Averroes' work was published in thirty-eight volumes. And thanks to the Spanish Jews and, in particular, Maimonides, who, like Averroes, was also born in Cordova, the first school of Averroism was established. The impact of Averroes philosophies was such that they continued to provoke debate throughout Europe for several centuries after his death.

Much later, Cervantes, living astride the sixteenth and seventeenth centuries, the Spanish “Golden Age,” would die in poverty because of indifferent patrons. Despite his monumental contribution to the Spanish language, literature and culture, Cervantes was ignored by philistine aristocrats like the Archbishop of Toledo, the Count of Lemos and the Duke of Bejar whose patronage he had sought in vain. By contrast, during the succession of golden ages that Islam had inspired, geniuses like the Africans Ziryab and Ibn Khaldun, and the Arab Averroes, had unlimited resources placed at their disposal and were acclaimed and revered by highly educated and enlightened rulers.

There can be no denying the fact that Moorish scholarship and Moorish culture as a whole, had an intellectual ripple-effect on Europe. They moved in concentric rings from centers of learning to the most backward areas of the



Figure 3. A nobleman of the Gonzaga family. (See their son in Figure 4.)

continent. Their geographers and mathematicians measured global distances accurately for the first time. Without the improved Moorish/Arab astrolabe, the lateen sail and the advances made by Arabs in navigation, astronomy and the nautical sciences in general, Columbus would have been incapable of acquiring the rudimentary and imperfect navigational skills that he used during his four voyages to the Americas. It is also true that the idea of sailing west in order to reach China and India would never have crystallized in a mind trapped in the thralldom of medieval superstition, the way Columbus mind was when he left his lowly birthplace outside of Genoa.

Moorish sensibilities encouraged not only a flourishing of scholarly endeavors, but also the broadening of humanistic expression in a Europe emerging from the throes of the Dark Ages. Moorish Spain became a cultural and intellectual Mecca where all the great manuscripts and learned texts were collected, translated and classified, and where scholars from far and wide could gather to peruse them.

The creative and symbiotic relationship between oral and written poetry, song, music, rhythmic speech patterns and finally, prose, in Moorish Spain, provided the models that would subsequently lead to some of the finest literary works to appear on the European continent. The much touted Spanish *siglo de oro* (Golden Age), with its fecund output of literary and other creative works, is often depicted as a phenomenon that happened unto itself in a Hispanic cocoon. The truth, however, is that it had roots in the Moorish/Jewish African cultures which remained buried deep in the Spanish psyche long after both Moors and Jews were cruelly expelled from Spain, and the Spanish and Portuguese who had been conquered for so many centuries by the Moors, had turned the tables and become the conquerors of the Moors not only in the Iberian Peninsula but also in their African homeland. Andalusian/Moorish cultural influences exercised a profound influence on the writings of Cervantes (1547–1616), Spain's greatest literary figure. And those Andalusian/Moorish influences were further strengthened by Afro/Arabic cultural infusions acquired during the years he spent in North Africa as a prisoner of a Moorish ruler, who, because of Cervantes' wit and creative intelligence — qualities that his well educated Moorish captor discerned and admired — wrongly assumed that he was worth a large ransom.

It is ironic that, to this day, the Spanish in their homeland, and the *mestizo* (Hispanic, African and Amerindian racial mixtures) ruling elements in Latin America, continue to make derisory noises about the 'purity of their blood' in order to banish unconscious memories of ineradicable Moorish/Jewish/African cultural and racial infusions. Regardless of skin color and feature, they are forever ready to choose the barbaric white Visigoths as ancestors rather than the dark-skinned and civilized Moors.

The early non-secular writing in al-Andalus was of two basic types: a) scientific treatises and geographical, historical and ethnographical accounts,

and b) Arabic poetry closely paralleling that of its Middle Eastern, Eastern and North African cultural relatives of the Islamic family. However, the music, the songs and the folk myths were always there throbbing like a pulse under the flesh of the society. From about the 10th century, as al-Andalus asserted its cultural independence, Moorish poetry began to take on a new and vibrant quality and two new types, the *muwashshah* and *zajal*, appeared.²⁹ In contrast to classical Arabic poetry, *muwashshah* and *zajal* drew their texts from a particularly al-Andalusian context, using not only the typology but also the indigenous linguistic and mythopoetic expression of its inhabitants. This particular quality of expression was likely the outgrowth of the intimate contact between the Arabic and Romance languages, out of which a kind of sparkling chemistry resulted. These very cultural catalytic agents that transformed the Islamic culture in Spain — language, intellectual cross fertilization, religion and a collective and ineluctible creative imagination — pushed and prodded restless and contentious Christian kingdoms into uniting and finally overcoming the combined threat of Moorish rule and their own backwardness.

The distinctions between *muwashshah* and *zajal* lay primarily in the choice of language. *Muwashshah* poetry still used classical Arabic, while *zajal* poetry relied almost entirely on a mix of colloquial Arabic and the local Romance dialects of al-Andalus. Nevertheless, both had a rhyming structure and subjects that were immediately accessible and appealing to listeners and, thus, were easily learned, retained and embellished upon. Needless to say, traditionalists of the time were extremely loathe to accept this uniquely Moorish poetic expression which refused to conform to time-honored Eastern poetic tradition. What they were unable to foresee was that the Moorish poetic vision which synthesized multi-cultural influences — Arab, African, European — would inject new creative life into what was effectively a dying art. Classical Arabic poetry was well into its decline when the Moors, themselves the product of constant cultural cross fertilizations, created the basis for a new enlightenment in a region that the Vandal and Visigoth invasions had left culturally impoverished.

Al-Andalusian music, songs and poetry — the three are invariably close as flesh to bone and sinew — flourished and were wildly popular not only among Moors, but throughout al-Andalus and beyond. After eight hundred years of Moorish presence on the peninsula, with Arabic-speaking Moors and a Romance-speaking populace sharing the same environment, Andalusians had developed various levels of bilingualism at many day-to-day levels. The plethora of Arabic infusions into the languages of the Iberian Peninsula and its neighbors attest to this. Through the long-standing Moorish presence in al-Andalus, Arabic provided Europe with words, such as: guitar (Arb: quintar, Sp: guitarra), lemon (Arb: laymun, Sp: limon) and algebra (Arb: al-jabr, Sp: algebra),³⁰ not to speak of a whole slew of other mathematical, chemical, administrative, botanical and herbal terms.³¹ Over time, the Muslim popula-

tion of al-Andalus grew from its relatively small Arab and Moorish core with the addition of converted Arabic-speaking Christians, or *muwallads*, such that the former Christians (i.e. Muslim converts) made up the majority of the population.

Ibn Guzman, an 11th century adventurer and poet who used both Arabic and the local Romance dialects in his work, was extremely popular and did much to spread the two forms throughout the region. As a distinction from the traditional courtly love song, those of Ibn Guzman were unabashedly sensual.³² The *minnesongs*, or courtly love poems, that first appeared in Provence were no doubt inspired by the intimate contact between this region and Moorish Andalusia. Prince William of Aquitaine, the first known poet of courtly love to write in vulgar Latin, was literate in Arabic. And it is evident that Dante's "Beatrice" stems from this Moorish contact.³³

The *Chanson de Roland*, composed in the late 11th century, allegedly immortalized Charlemagne's expedition against the Muslim-held stronghold of Sargossa in 778; however, the poem is filled with fantasy and wish fulfillment, in short, the poetic licence that the oral tradition accorded to troubadours of that age of awakening to the beauty of language and song. Another poetic record, the Arabic *Poema del Cid*, written around 1140, described the same occurrences; however, this poem was both elegant and historically accurate. Cervantes' *Don Quixote* with its stories inside of stories, is impregnated with myths and folk legends from Andalusia. That immortal comic hero, Don Quixote de la Mancha, while on his deathbed, confessed that he was mesmerized by what he described as "those profane stories dealing with knight-errantry." True enough, his books of chivalry went back to Amadis of Gaul, but the Moorish tales of courtly love, the songs, the legends which had touched Cervantes' imagination in Andalusia, gave an immediacy to his tale of the mad and melancholy knight who tilted at windmills. (See figure 4.)

Defoe's *Robinson Crusoe* was clearly influenced by Ibn Tufail's (c. 1105–1185) work *Hayy ibn Yagzan (Alive, son of Awake)*.³⁴ This, plus the more current stories of shipwrecked sailors going the rounds in a new age of discovery and exploration enlivened and expanded Defoe's imagination. The Hispanic/Moorish tradition of the *picaresque* novel had a profound influence on English writers like Fielding and Defoe.

Besides poetry, al-Andalus offered Europe new kinds of songs, music, and dance. Poetry lends itself to musical expression and to the use of myths and the rhythms of speech of storytellers, and the Andalusians, through their contacts with the Persians and Indians, had synthesized new forms of expression which they then brought to their poetry. Ibn Quzman, a well-known Cordovan *zajal* poet of the time, made his living by travelling about the region reciting his poetry which he often accompanied with a lute, flute or drum.³⁵ Singing in the Andalusian style is still recognized today as a unique form of inspired



Figure 4. African wife of the Gonzaga nobleman. (See his wife in Figure 5.)

creative expression, and so is the flamenco dance. Those Andalusian traditions have travelled to far corners of the former Spanish empire. Their rhythms still throb inside the culture of the gypsies and the poetry of Lorca. And Borges, the Argentinian writer, despite strident claims to being a descendant of Visigoths (only a partial truth), used to have his Andalusian secretary sing his prose back to him.

But Moorish Spain also gave Europe new instruments with which to play the music and to accompany the songs and dances, such as: the lute (Arb: ud, Sp: laud) and the guitar (Arb: qitar, Sp: guitarra). The most important figure in the spread of Moorish musical and poetic expression was Abu 'l-Hasan 'Ali ibn-Nafi' (789–857), who was more commonly known as “Ziryab” because of his dark complexion. In Arabic, “Ziryab” refers to a bird with black plumage.³⁶

Ziryab was born in Mesopotamia, and brought up and educated in Baghdad. Originally a slave of the famous musician Ibrahim al-Mawsili,³⁷ some stories tell that Ziryab's musical talents so impressed the Caliph Harun al-Rashid that al-Mawsili became jealous and tricked him into fleeing the country. Another side of the story is that this was a period of civil wars and Ziryab chose to take his family to safety. He and his family did flee to North Africa where he took up residence in the court of Ziyadat Allan I, in Qayrawan, one of the major Muslim cities in North Africa. His African origins and his prolonged sojourn in Africa undoubtedly played an important role in his musical development. So when he finally settled in Cordova in 822 at the invitation of al-Hakam I and, subsequently, at that of 'Abd al-Rahman II, a new creative flowering was to manifest itself. 'Abd al-Rahman II was so delighted to have Ziryab in Cordova that he gave him a furnished mansion, gifts and a stipend, including 200 dinars per month for himself, 20 dinars to each of his four sons, a bonus of 3,000 dinars per month, and 500–1,000 dinars for special religious festivals.³⁸

Ziryab's remarkable and varied accomplishments in the ninth century remind one of other Black artists, musicians, composers, writers who were to function with distinction in Europe in the face of almost insurmountable obstacles many centuries later. Ziryab was the forerunner of Soubise, the Chevalier St. Georges, the Chevalier Ira Aldridge, Alexander Dumas, Pushkin and others. His talents stretched from music through the introduction of social customs to botany and chemistry. He is credited with having known a thousand songs by heart, and having developed a new five-stringed lute, the predecessor of today's guitar. He was the first to found a conservatory of music in Cordova, and his students were to spread his inspired teachings even further through their own contributions later in the century.³⁹ He introduced new dress-styles, using different colored garments to match the season. And he created hairstyles to go with the attire. He transformed eating habits and the ritual of serving meals by using elaborate decorations at the table and eating food in courses instead of having it all laid down on the table at the same time. He

even made a contribution to dental hygiene by inventing a toothpaste that was both functional and pleasant to taste. And, it was Ziryab, the botanist, who introduced the asparagus to Europe.⁴⁰

Accorded the highest favors in the Cordovan court of 'Abd al-Rahman II,⁴¹ Ziryab was so prominent that his fortune was valued at over 300,000 dinars and his influence stretched from Cordova throughout the other provinces and across the Mediterranean to northern Africa.⁴²

The story of Ziryab's ascendance from slavery to unbelievable fame and fortune, underlines a fundamental difference between slavery in the Islamic world and slavery during the Columbian era. Like Aesop (Athiops the Ethiopian) who lived in ancient pre-Islamic times, a Black slave endowed by Nature with genius, wit and good luck could rise to unbelievable heights during his or her lifetime. Besides, Aesop and Ziryab both lived at a time when slavery was an *equal opportunity* institution and all races, colors and creeds were liable to end up as victims in Middle Eastern and other slave markets. In those slave markets, too, white slaves far outnumbered black ones, hence the word “slave” deriving from “Slav.” This tradition of a color-blind slavery was carried on for a while at the beginning of the Columbian era when white slaves were introduced into the Americas. But with the demand for labor to produce sugar mushrooming, the terms “African” and “slave” became synonymous in the New World.

After the *Reconquista*, the tables were turned on the Muslims and they became the object of deep-seated Christian animosities. Though deprived of their language—Arabic—the Moors nevertheless developed an interesting form of protest: while they agreed to converse and express themselves in the local Spanish dialect, their literary expression continued to use Arabic letters. Thus was born *aljamiado* literature⁴³ which was to provide a particularly vital link between Moorish mythopoetic tradition and the newly-developing Romance language literature.

Moorish Spain's infusions into European literary culture are legion and can be seen in the work of writers as varied as Cervantes, Lorca, Dante, Defoe, Fielding, Shakespeare, Roger Bacon, Albertus Magnus, among others. Thematic strains repeat themselves in European writing, such as the ascension of Muhammad to the seven heavens in Dante's *Divine Comedy*, which some contend is a version of the Arabic legend of the *Mi'raj*.⁴⁴ Moorish expression provided the style and format for the *picaresque* novel (a format with a rogue or eccentric anti-hero as the central character), as seen in the work of English writers like Defoe and Fielding who were profoundly influenced by the writings spilling over from the Spanish Golden Age. Moorish cultural infusions can also be seen in the subject matter or objects of concern expressed in work, such as Shakespeare's *Othello*, *Merchant of Venice* or *Titus Andronicus*, or the famed French *Chanson de Roland*.

Shakespeare, like many of his contemporaries in 16th century London, had

easy access to writings and firsthand accounts of the splendors of Moorish cities and the wealth, nobility, valor and civilized accomplishments of Moorish rulers. Queen Elizabeth the First, not to speak of the burgeoning and increasingly influential English mercantilist class, was keen on maintaining a healthy trade with what they called the “Barbary coast” (a North African littoral stretching from Morocco to Tunisia), and the Islamic world of the Mediterranean and Middle East in general. In addition to Shakespeare’s wealthy and powerful patron, the Earl of Leicester, the Bard from Stratford also had many merchant friends from whom he could milk information about Morocco and the Moors. Shakespeare also knew Master Roberts, Elizabeth’s ambassador to Morocco and Merzouk Rais, the Moroccan ambassador to London.⁴⁵

W.H. Auden described Shakespeare’s *The Merchant of Venice*, as one of the Bard’s ‘Unpleasant Plays’ and then he went on to add, ‘in the real world, no hatred is totally without justification, no love totally innocent.’ And, indeed, in *The Merchant of Venice*, one of those indifferent works that a great writer is occasionally guilty of penning, Shakespeare’s portrayal of the Prince of Morocco, stands out in glaring contrast to Shylock, his racist caricature of a Jew; and, in his last play, “The Tempest,” to Caliban, a deformed symbol of the colonized man. The dark-complexioned Prince of Morocco is noble, brave, immensely wealthy and powerful and he shares the same status as a suitor for Portia’s hand as the Prince of Aragon. Shylock, on the other hand, is too evil to be true. He is more of a metaphor for usury and venality than a human being. And, Caliban, a half-wit born in the imaginations of early European explorers and colonizers, is a racist symbol that Shakespeare borrowed.

Shakespeare, a stay-at-home, endowed with the creative imagination of a genius, explored the most distant reaches of the earth, through the writings of others. But he also, inadvertently, echoed some of their prejudices. By debasing Shylock’s humanity, Shakespeare diminishes that of the Duke of Aragon, and the Prince of Morocco as well, and this trivializes both Portia and her high-born suitors.

From the moment the Prince of Morocco makes his entrance with a flourish of cornets, he draws our attention to his African origins. Was this really necessary?

*Mislike me not for my complexion,
The shadowed livery of the burnished sun,
To whom I am a neighbour and near bred.*⁴⁶

And when he, the Prince, must pick one of three caskets, Portia tells him as though she is deferring to him grudgingly,

*If one of them contains my picture, Prince.
If you choose that, then I am yours.*

The Moor chooses the wrong casket and bows out graciously,

*Portia, adieu. I have too grieved a heart
To take a tedious leave ...*

And Portia, who is in love with Bassanio, declares with a sigh of relief,

*A gentle riddance. Draw the curtains. Go.
Let all of his complexion choose me so.*

But Portia’s final comment on the Prince of Aragon is more trenchant, and smacks of the malicious,

*Thus hath the candle singed the moth.
O, these deliberate fools! When they do choose,
They have the wisdom by their wit to lose.*

And, Nerissa, her equally cynical, malicious and worldly-wise waiting-gentlewoman observes,

*The ancient saying is no heresy.
Hanging and wiving goes by destiny.*

“Hanging and wiving?” — the Renaissance was for men, European men, and not for women of any color. The urbane and civilized Moorish tolerance that had allowed women to win new freedoms for themselves, was now replaced by a crafty, and at times, murderous male intolerance; and daughters were chattel to be sold to the rich and powerful. The Prince of Morocco was Black, but he was also as much a power to be reckoned with as the white Prince of Aragon. With the advent of the Renaissance in Spain, women lost the considerable ground they had gained during centuries of enlightened Moorish rule. The writings of the Spanish Golden Age are littered with tales of wife murder. A husband, in order to save his “honor,” had the right to murder his wife if he suspected her of infidelity. But these murders were not simply individual acts inspired by psycho-pathological obsessions with issues of power and control over other human beings. They were upheld, condoned and encouraged by a male-dominated Church and State. So much for this “new age of enlightenment!” By contrast, as Flora Shaw points out,

It is ... interesting to note that in the days of Mohammedan Spain, [Moorish] women were not confined, as in the East, to harems, but appeared freely in public and took their share in all the intellectual, literary, and even scientific movements of the day. Women held schools in some of the principal towns. There were women poets, historians and

philosophers, as well as women surgeons and doctors An example of this was that the daughter and grandmother of the celebrated Moorish Pharmacist, Ibn Zohr, were both accomplished female doctors.⁴⁷

So, not only were Moors, Jews, Indians, slaves of every color and colonial subjects in general, *Calibanized*, so were women, and after the *Reconquista*, they had to be dragged backwards into the future with the rest of the subject peoples.

For a short span of time, the Moor was not demonized in Shakespeare's England, the Jew was. But later, when the Atlantic slave trade had to be justified, the African became the victim of a strident demonology, The *noble Moor* was labelled a "Black-a-Moor" and even more contumely and racial hatred were heaped upon his head than that which the Jew had already known for centuries. But this created a glaring contradiction: how could the Black-a-Moor be equated with the Moors who had civilized Spain and Portugal, and acted as a vital connecting link between Europe's past and its future? This contradiction was resolved by means of a racist *double-think* that became the hallmark of Eurocentric scholarship. Flying in the face of truth, these scholars proceeded to attribute everything good and noble to the white Moors and everything evil, malevolent and savage to the black Moors. This schizoid dialectic thus enabled those Eurocentric scholars to keep their racist clichés and their racial fantasies intact. An interesting example can be seen in the way that the famed "Lord of the Negroes of Guinea", Mansa Musa (the Mandingo Muslim monarch who ruled Mali from 1307 to 1332), was depicted in the maps of the 14th and 15th centuries. (See figure 5.)

The Moorish gold trade was well established and vital to the rulers of Europe from the 14th century onwards, hence cartographers, recognizing the importance of locating these crucial linkages, included Mansa Musa and his Malian kingdom on their maps. On the famed 1375 Catalan map drawn by Abraham Cresques of Majorca, Mansa Musa (also known as "Musa Mali") was depicted as, "a monarch seated on a throne ... in royal robes and a crown, [holding] a sceptre in one hand and in the other a nugget of gold."⁴⁸ Mansa Musa and his kingdom appeared on the maps over a period of nearly 200 years up through that produced by Martin Waldseemuller in 1516, even though Mansa Musa, himself, died in 1332. But, the European racist mind-set had great difficulty in reconciling its prejudicial world-view with the fact that this black African ruler was equal to, if not wealthier and more powerful than their own. Thus, over the years of map production, different cartographers tried to reconcile this difficulty by changing Mansa Musa's image at first to conform more to the European phenotype and subsequently, to take away his trappings of power and prestige. Angelino Dulcert of Majorca's 1339 *mappae-mundi*, the first time that Mansa Musa appears, represented the monarch with a short, stubby beard—more closely approximating the 'image' of a Negro. Later cartographers, feeling uncomfortable that so important a ruler was not a

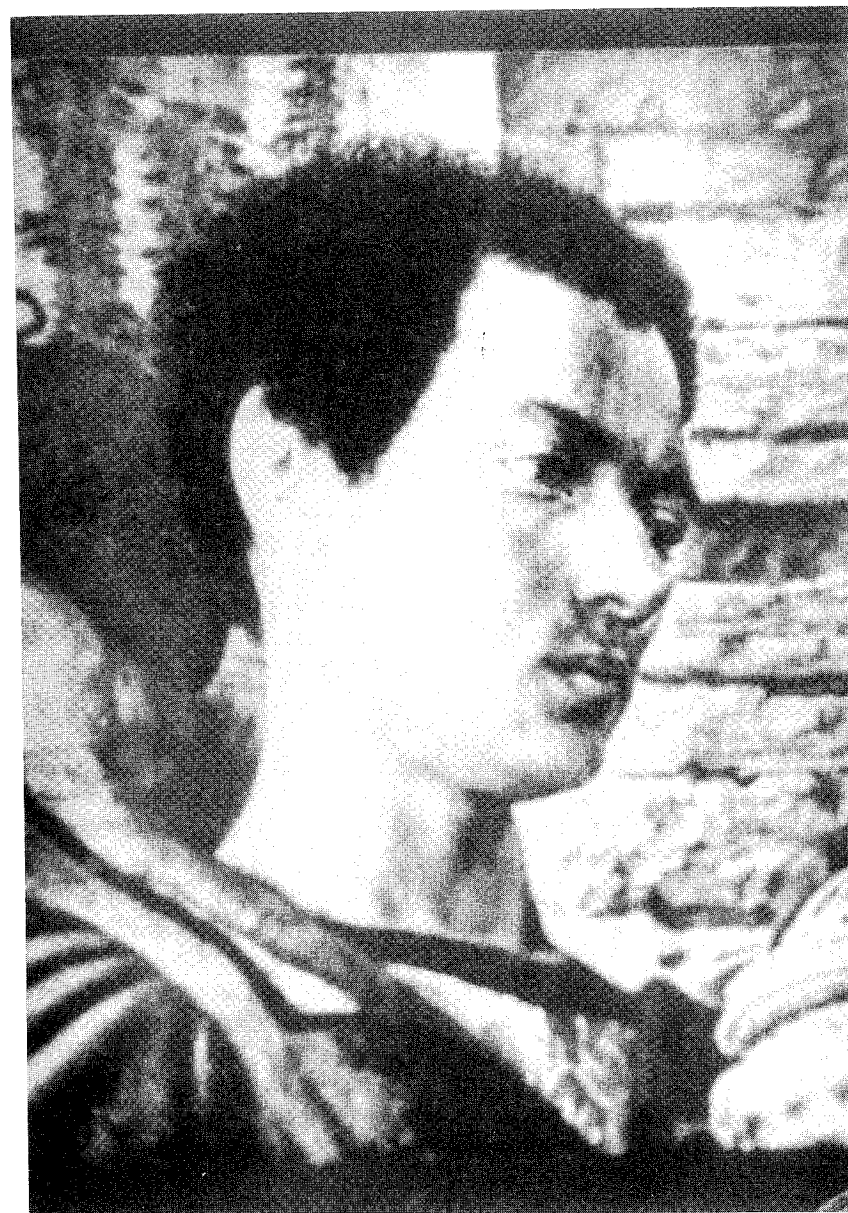

Figure 5. Son of the Gonzaga family (Model for Othello).

European, changed his beard to the long, flowing lines of a European monarch, although his skin remained dark. Finally, the cartographers' resolution was to depict Mansa Musa as "seated on a throne, crowned and robed, but with the royal robe cut down to a brief cloak, and otherwise stark naked," — a more 'accurate' representation in keeping with the prejudicial precepts of the Eurocentric mind.

When the Chevalier Ira Aldridge, the famous nineteenth century African-American actor, played the part of Shylock in St. Petersburg and other European capitals, Aldridge 'Africanized' Shakespeare's caricature of a Jew and portrayed Shylock as the tragic figure he was: an unfortunate and sensitive human being caught in a web of racist intrigues. He showed how there was a double standard by which Gentiles could practice and preach the new ethic of capitalism — profits above morality — but if a Jew (and one could add "Moor" in the same breath) tried to do the same thing, then his every thought, word and deed was excoriated and denounced as being usurious, immoral and un-Christian. Aldridge also deleted the last part of the play. The persecuted Jews of Czarist Russia presented Aldridge with a golden plaque saying that it was the first time that they had been portrayed with dignity in that prestigious St. Petersburg theatre. Aldridge, acting in the great theatres of Europe and England at a time when his people were still slaves in America, had shown that the *pound of flesh* which Shylock was demanding was a metaphor of the ultimate greed for profit that placed little value on human life, and, therefore, what Shylock was highlighting for his Gentile tormentors, was their own ethic of the slave market and its inhuman trade in pounds of flesh for profit.

Between the racist caricatures of *Shylock*, the Jew, and *Caliban*, the permanent black slave, were Shakespeare's swarthy Moors, The Prince of Morocco, Othello, and Aaron in *Titus Andronicus*, and herein lies the contradiction in the European mind. Shakespeare's concept of the "Moor" was not without its imperfections, even though his portrayals of the Prince of Morocco and Othello might, at first, strike one as being authentic. The Prince, despite his eloquent avowals of love for Portia, bows out graciously when he opens the wrong casket. For him, a civilized sophisticate, this was all part of an urbane game of love. Although his color mattered to Portia, her color mattered little to him. As far as he was concerned she was highborn, well-bred and attractive. But as the Prince of a powerful State, the choices for him were wide and varied, and he could pick and choose the bride he wanted from women of any race, color or creed. It was class and wealth that mattered to him, not skin color.

Othello, though, is a professional soldier and not an effete courtier. He came to decadent, worldly-wise Venice, with the charisma of an eagle-eyed, Black Almoravid General, and a contempt for the city that a field commander who spent most of his life campaigning, feels instinctively. The Prince, as an urbane city denizen who understood the intrigues that were spawned endlessly

in his Royal Court circles, would have seen through the wiles of the likes of Iago immediately and had him arrested and banished. But Othello, although he fell victim to Iago's vile intrigues, as an Almoravid General, would hardly have been a naive creature prone to give reign to blind, uncontrollable passions. He had, after all, fought against, outwitted and defeated clever foes, and he would thus have had to be endowed, not only with phenomenal physical courage, but also with a cold, calculated intelligence, cunning, good judgement and a superb sense of timing. (See figure 6.)

Still, Othello was also an uprooted African man, and in his tragic encounter with Desdemona, he was re-living the Antaeus legend — the further he was removed from the smell of his earth and the dreams of his people, the weaker, more confused and vulnerable he became. This invincible general on the battlefield is, therefore, brought down by a tawdry intriguer. Shakespeare, endowed with an inner ear for the winds of change blowing across Renaissance Europe, created through his Othello, an archetypal symbol of a noble African who will be tricked and brought low by a clever European trickster. A cynic like the Prince of Morocco would have said of him, that he was 'too noble for his own good.' But apart from other considerations, Othello is also the symbol of an uprooted man in a new age of rootless human beings, wanderers and adventurers. In Venice, his African persona diffuses itself and becomes the subject of reminiscences to entertain and enthrall Desdemona. He never once mentions the African woman who mothered him, and ignoring his mother, he becomes a man without a sense of place, bereft of country, family and clan. His final passionate outburst, then, is more an impotent rage against himself. He had tried to replace the loss of psychic roots and a psychic identity with his love for an ideal and not a flesh-and-blood woman, and he had failed.

Cervantes, Spain's Shakespeare, echoes the songs, and stories of al-Andalus, (Andalusia) the heartland of Moorish Spain, in his novels, poetry and plays. He had heard the living echoes of Moorish music in the Andalusian *cante jondo*, and in the *saeta*, the improvised and spontaneous "arrow song" with sad wavering laments, and its poignant rhythms had entered his consciousness both in Algiers and at home in Spain. The tales of knight errantry and courtly love which obsess Don Quixote were filtered through nearly a millenium of the Moorish/Islamic experience. For, indeed "Throughout the Islamic world there were brotherhoods, that may be described as orders of knights, which were ... enriched by mysticism, as in the case of the Christian orders of knights. Their motto was the Arabic expression *futuwa* [meaning] magnanimity ... the chivalrous virtues of fearlessness, charity and generosity. *L'amor e il cuor gentil sono una coas* — 'love and a generous heart are one and the same thing,' " said Dante.⁴⁹

The distances Shakespeare covered in his lifetime between Stratford-on-Avon and London, were very short indeed, but the world of his imagination encompassed most of the globe. Cervantes, on the other hand, was a soldier of

fortune, a King's messenger, a purveyor to the fleet in Andalusia requisitioning supplies for the Invincible Armada. He had also been a prisoner of the Moors in Algiers for five-and-a-half years, and an inmate of a debtor's prison at home. He was a wanderer in an epoch of men without a sense of place, men who had cut themselves off from women, family, country and who lived in a world of dreams and the wildest fantasies. But for a trick of fate, Cervantes would have wandered even further and lost himself in the wide indifference of the Spanish Empire. Fortunately for us, his application for a job overseas as a colonial official was turned down. For had he been appointed, Don Quixote, the gently insane Knight of la Mancha, would, perhaps, never have been created.

Othello, Columbus and Don Quixote are inexorably linked together. Othello was an African, an Almoravid, who had vaulted over the Pillars of Hercules and released Europe from the thralldom of its medieval backwardness. Othello was also an uprooted African genie springing out of Shakespeare's magical literary lamp. But in shaping him into a character for the English stage, the Bard from Stratford had inadvertently de-Africanized Othello. He portrayed him as a man alone — no mother, father, no extended family — did he just fall upon the earth like a fragment from an asteroid?

The three, Othello, Columbus, Don Quixote, were men without a sense of place. They were like that character in Greek mythology who was doomed to exist suspended between earth, sky and sea. These male archetypes of a rootless age, were men without the enfolding warmth, humanity, strength and wisdom of women.

Deriding the idea of Columbus' alleged love and devotion to Spain, Charles Duff wrote:

Historians have attempted to show that Columbus loved Spain and that this country was his spiritual home. To this distraught fanatic a country meant about as much as family or marriage ... and he ... would have tried Spain, Italy or any country likely to support his project.⁵⁰

And to Italy and Spain, one could add Portugal, England and France. This man Columbus was the archetype of the new being without a sense of place, one without roots in a speck of the earth that he could call his own. He, therefore, remains like a spectre to haunt us down the ages. But the label of 'rootlessness' can be pinned with equal facility upon those other archetypes — Othello and Don Quixote — the one Black, the other white, but both doomed to live through epochs of homelessness. Caliban, another character created by Shakespeare, is the deformed and mentally retarded *soul brother* of The Prince of Morocco, Aaron and Othello. The defeat of the Moors deformed the European vision of Africa and Africans. A mutation in febrile and prejudiced European imaginations then proceeded to transform black princes into eternally craven slaves. A New Order of racist fantasies and the oppression of peoples of color had to be justified.

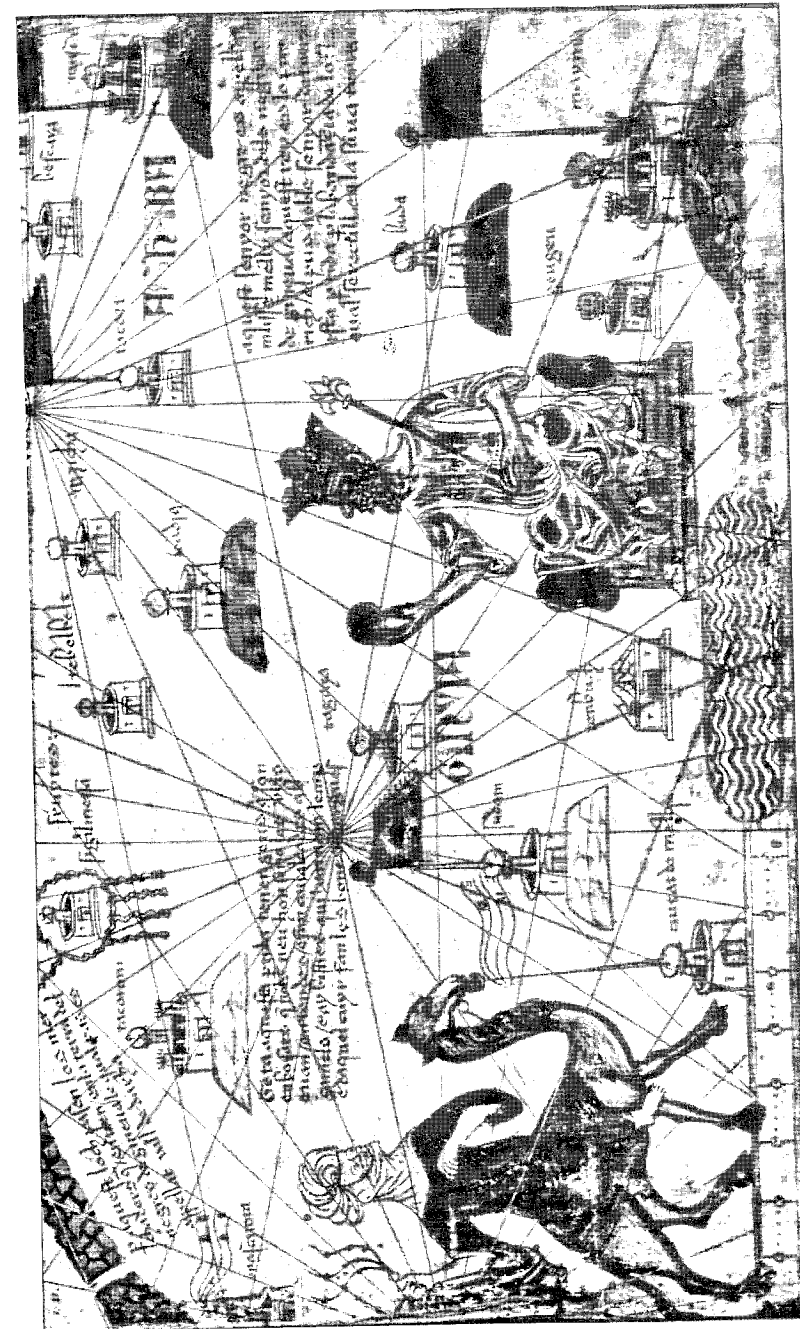

Figure 6. Musa Mali [Mansa Musal], Lord of the Negroes of Guinea, from a panel of the Catalan Map of Charles V (1375). Source: The Golden Trade of the Moors, Bovill, frontispiece.

Poets, Shelley once declared, hold up mirrors in which societies can see themselves. The Moorish poets held up these mirrors for almost a millenium, and Europe, seeing herself, stirred and stumbled forward from the Middle Ages into the Renaissance. But once she, *Europa*, a continent named after a woman but dominated by men for millenia, had attained the 'utmost rung' of 'ambition's ladder,' she was forced by male chauvinists to turn her back (with apologies to Shakespeare):

...unto the ladder
Scorning the base degrees by which [she] did ascend."⁵¹

Notes

1. Jan Read, *The Moors in Spain and Portugal*, Totowa, NJ: Rowman and Littlefield, 1975, p. 217.
2. Jan Read, *Op. Cit.*, p. 201.
3. Jan Read, *Op. Cit.*, p. 219.
4. Jan Read, *Op. Cit.*, p. 218.
5. *Ibid.*, p. 100.
6. *Ibid.*
7. Kirpatrick Sale, *The Conquest of Paradise*, New York: Alfred A. Knopf, 1990, p. 18.
8. The Arabic names and words are taken from various sources, many of which do not use the same phonetic representation for similar words. Written Arabic uses only consonants and the vowels must then be surmised from the context. This applies as well to some consonants, such as the hard 'g', 'q', and 'k', which are frequently used to represent the same sound.
9. Jan Read, *Op. Cit.*, p. 224.
10. *Ibid.*
11. Wayne B. Chandler, "The Moor: Light of Europe's Dark Age," in Van Sertima, ed., *The African Presence in Early Europe*, New Brunswick, NJ.: Transaction Books, 1985, p. 151.
12. *Ibid.*, p. 152.
13. Jan Read, *Op. Cit.*, p. 124.
14. Anwar G. Chejne, *Muslim Spain: Its History and Culture*, Minneapolis: U. of Minnesota Press, 1974, p. 78.
15. Jan Read, *Op. Cit.*, p. 124.
16. *Ibid.*, p. 163.
17. Titus Burckhardt, *Moorish Culture in Spain*, New York: McGraw-Hill, 1972, p. 124.
18. Anwar G. Chejne, *Op. Cit.*, p. 69.
19. *Ibid.*, p. 274.
20. M. A. Martin, "'Abd ar-Rahman bin Muhammad bin Khaldun," in John R. Hayes, ed., *The Genius of Arab Civilization*, Cambridge: MIT Press, 1978, p. 73.
21. M. A. Martin, *Op. Cit.*, p. 73.
22. Jan Read, *Op. Cit.*, p. 234.
23. Jan Read, *Ibid.*
24. Jan Read, *Op. Cit.*, pp. 80-81.
25. *Ibid.*, p. 82.

26. Anwar G. Chejne, *Op. Cit.*, pp. 404-405.
27. Jan Read, *Op. Cit.*, pp. 187-179.
28. Anwar G. Chejne, *Op. Cit.*, pp. 329-333.
29. *Ibid.*, pp. 236-246.
30. *Ibid.*, p. 194.
31. Jan Read, *Op. Cit.*, p. 178.
32. Titus Burckhardt, *Op. Cit.*, p. 109.
33. *Ibid.*, pp. 87-88.
34. Rom Landau, *The Arab Heritage of Western Civilization*, NY: Arab Information Center, January, 1962, p. 68.
35. Anwar G. Chejne, *Op. Cit.*, pp. 241-242.
36. Jan Read, *Op. Cit.*, p. 65.
37. Anwar G. Chejne, *Op. Cit.*, pp. 372-374.
38. *Ibid.*, p. 373.
39. *Ibid.*, p. 393.
40. Wayne B. Chandler, *Op. Cit.*, p. 161.
41. Titus Burckhardt, *Op. Cit.*, p. 71.
42. Anwar G. Chejne, *Op. Cit.*, p. 372.
43. *Ibid.*, p. 166.
44. *Ibid.*, pp. 404-405.
45. Landau, *Op. Cit.*, pp. 72-73.
46. William Shakespeare. "Merchant of Venice," in *The Complete Works of William Shakespeare*, New York: Bantam Books, 1980, Act II, Scene 1, lines 1 - through Act II, Scene 9, lines 83, 34.
47. Wayne B. Chandler, *Op. Cit.*, p. 174, endnote 50.
48. E. W. Bovill, *The Golden Trade of the Moors*, London: Oxford University Press, 1958, p. 91.
49. Titus Burckhardt, p. 109.
50. Charles Duff, *The Truth About Columbus*, Random House, NY: 1936.
51. William Shakespeare, "Julius Caesar," in *Op. Cit.*, Act II, Scene 1, lines 25-27.

THE MUSIC OF THE MOORS IN SPAIN

(AL-ANDALUS, 711-1492 A.D.)

ORIGIN OF ANDALUSIAN MUSICAL ART:

ITS DEVELOPMENT AND INFLUENCE ON WESTERN CULTURE

Yusef Ali

The artistic Spain of olden times thus becomes the central bond which ties ancient art to modern. The great musicians of Andalusia knew not only how to preserve their inherited art but also how to transform and renovate it by creating a popular form through which their compositions were broadcast, thus spreading all over Europe. There it still lives because the people have loved it and adopted it. Europe therefore owes a debt of gratitude to the Andalusian Moors, who maintained and passed on a rich fund of music, a perennial spring to which all European composers have come to renew their inspiration, but without seeking its unknown sources.

Music in Ancient Arabia and Spain
— Julian Ribera

African music is usually perceived as being one-dimensional, primarily rhythmic in character and totally dominated by drums. Chernoff says: "If you ask people what African music is like, most will, with little hesitation and great confidence, tell you that African music is all drumming: Africans are famous for their drumming. It is exactly this mass impression that ethnomusicologists, those people who study music academically, love to correct. Anyone reasonably well informed about music-making in Africa will immediately react against such a naive notion by citing a wealth of musical instruments: xylophones flutes, harps, horns, bells."¹

A major reason for this erroneous perception is the way the Western world continually portrays the African musical expression. The images usually depicted in the typical Western interpretation have traditionally been of "natives" dancing with emotional abandon to the beat of "jungle drums." During the 1940 and 50's there were some dancers and choreographers such as Kathryn Dunham, Carmen de Lavallade and Geoffrey Holder and others who presented musical performances with traditional African music and dance as a high musical art form; but this was not the norm. Today African music with drums and a variety of other African instruments with more positive images, have seen increasing popularity in Jazz, popular music, as well as traditional African musical performance in the West.

The new movement in America, beginning in the sixties, by those of

African descent, to embrace African history, literature, customs and cultural traditions has had significant impact. As a result, the focus on African studies in colleges and universities, the adaptation of African dress and hairstyles, musical performances on the national and international level, have brought renewed interest in the African continent.

"By far the most sophisticated responses to the popular image of Africa in the New World," says Okon Edet Uya "are the back to Africa movements, the Pan African movements and the new Black nationalism ... Whether it surfaced as emigrationism of the eighteenth century or the new black nationalism of the 1960's and 70's, this sentiment reflected a confidence in the capacity of the African to create and control his own reality, unfettered by European imperialism and neocolonialism and the contaminating influences of European culture."²

But while, for many reasons, this may be seen as progress, still there are clouds of myths that have to be stripped away so that there can be a clearer view of the realities. When it comes to African music, for instance, rarely is the total African musical experience viewed in all of its broad and rich diversity.

"For a Westerner to understand the artistry and purpose of an African musical event," says Chernoff "it is necessary for him to sidestep his normal listening tendencies, slow down his aesthetic response, and glide past his initial judgement. Perhaps more than the novelty or the strangeness of the sounds, the different meaning of a music which is integrated into cultural activities presents difficulties to the Western listener and undermines his efforts to appreciate and understand African music."³

But the problem is multi-layered and remain enormous. Centuries of misconception and prejudice has led to grave distortions.

"Africa has for generations now been viewed through a web of myth so permissive and so glib," says Bohannon "that understanding it becomes a twofold task: the task of clarifying the myth and the separate task of examining whatever reality has been hidden behind it. Only as it is stated and told can the myth be stripped away. Only if the myth is stripped away can the reality of Africa emerge."⁴

Exploring the Myths

Musicologists generally classify musical instruments into four categories: (1) Idiophones—marimbas, xylophones, gongs, rattles, bells, clappers, cymbals etc. (2) membranophones—drums with skin or membrane heads (3) Aerophones—flutes, whistles, pipes, trumpets and horns. (4) Chordophones—lutes, lyres, zithers, and harps.

While many membranophones are made from the trunks of trees, still others are wood bound with a variety of wood sources and other material

utilized today in Ghana and Kenya. Various skin covers are used, as Kebede says, "depending upon the geographic location and availability of the animal".⁵ The prevalence of trees in the sub-saharan great forest regions obviously allows easier access for the use of trees to construct membranophones. Once again we see the impact of geography on the use of musical instruments.

"Drums covered with hide," Frobenius points out, "are found throughout the whole of Africa, with the exception of its southernmost part the wooden drums, however, occur only in the Cargo Basin and in upper and lower Guines. The hide-covered drums are a development of the famous millet mortar, which points to East India. The civilization of the Mediterranean shores has similar drums made of clay, and related to those found in Persia and in prehistoric tombs of Germany. Now the wooden drums belong to the Malayo-Negrito elements of African culture. They reoccur in Melanesia and frequently in Polynesia. Their home obviously must be the same as that of the lofty bamboo cane, for these drums are developed from the bamboo. (1898: 640-41)⁶

This is a clear illustration of how music and musical instruments can be used as effective tools for studying people in culture, very often showing how they live and where they live.

North of the Sahara social and cultural factors impact on the use of Idiophones and Aerophones as the more dominant instruments.⁷

Another major misconception in regard to African Music is that the music of the Arabic speaking countries of the Maghrib (North Africa) Morocco, Tunisia, Libya, Egypt and the Sudan is not really African music. To understand why this misguided perception exists it is important to realize that the Maghrib is always viewed as separate from the southern region of the African continent. Although these countries are located in the northern region of the continent they are referred to as "a thin finger of Arabic or Islamic culture that extends from Egypt to the Atlantic." "Our attention is firmly fixed on an East-West cultural Axis," says Grame "to the near exclusion of the North-South one."⁸

For instance, rare is the reference to Egypt in African studies. *Ancient Egypt* is universally recognized as one of the most important centers of world culture and leader in the fields of science, medicine and architecture. Its *ancient* music also spread and influenced the Eastern and Western worlds.⁹

Experiments in ancient Egypt with a music notation system and the establishment of schools of music that taught vocal and instrumental performance made it among the first to do so.¹⁰

In the fourteenth century the exemplary sociologist Ibn Khaldun remarked, while commenting on scholarship and sedentary culture, "Today, no city has a more abundant sedentary culture than Cairo (Egypt). It is the mother of the world, the great center of Islam and the main spring of the sciences and the crafts."¹¹ "The Egyptians of Plato's time," Malm has noted "were still possessors of canted knowledge in both music practice and theory. Thus much

that we credit to Pythagorus and other Greek music theorists may have deeper roots in Alexandria and the Nile valley. In addition, the legacy of ancient Egypt is found in the shapes, tunings, and playing styles of such folk instruments as the *argul* double clarinets in Egypt, the *genibri* of North Africa, the many endblown flutes of the near East, the *hlam* of the Wolofs, and the *sistrums* of the Ethiopian Copts and the ancient Greeks and Romans.¹²

Ancient Egyptian music has never been studied in an African context. However, a study done by Sachs (cited in *The Anthropology of Music* by Alan Merriam) comments on the success of European musicologists in research on Egyptian musical instruments and antiquarianism. Sachs speaks of "the extreme aridity of the desert soil and the Egyptian belief in the magic power of painting and sculpture." [This] aridity has preserved hundreds of instruments from decomposition and many musical scenes are depicted on tomb walls. Egyptian art works are explained by short naive texts written between the human figures whenever an empty spot is left (Thus "he is playing the harp" or "he is on the flute"). Hence, we know the authentic names of practically all Egyptian instruments.¹³

The African-Spanish Connection

Westerners have long been captivated by the music of Spain, its haunting melodies and fascinating rhythms. About ten years ago, I was led to investigate the subject in an effort to learn more about the music of Spain, about its history and development in connection with my studies of African music and Western Culture. I began to listen to music of traditional folk and classical Spanish music. After reviewing music ranging over a broad spectrum, I came across several recordings that particularly stimulated my interest. Among them was a recording by the legendary Miles Davis entitled *Sketches of Spain*, which included a variety of Spanish themes with a rendition of Rodrigo's *Concerto de Aranjuez*. There was also another remarkable composition recorded in the 60's by the late great saxophonist John Coltrane entitled *Ole*.

The latter (*Ole*) was more in the classical Jazz tradition whereas Davis' "Sketches" with a large orchestra was a departure from the standard "straight ahead" Jazz form. Both of them, however, incorporated not only Jazz elements, but with the use of modal incantations, ostinatos, African polyrhythms and extended improvisation, suggested a musical legacy and heritage much more ancient than that of Spain.

Years later, in his autobiography, while reflecting on the character of the music he recorded on *Sketches of Spain* (1959), Miles Davis said: "The Black Moors were over there in Spain because Africans had conquered Spain a long time ago. In the Andalusian area you have a lot of African influence in the music, architecture and in the whole culture and a lot of blood in the people. So you had a black African thing up in the feeling of the music in the bag pipes and trumpets and drums."¹⁴

Referring to a selection called *Solea* he says: "Solea is a basic form of flamenco. It's a song about loneliness, about longing and lament. It's close to the American black feeling in the blues. It comes from Andalusia so it's African based."¹⁵

A Moorish civilization was on European soil from the eighth to the fifteenth century, rivaling in its "passion for literature, art and science," the Caliphate in the East. "The Moors organized that wonderful Kingdom of Cordova which was the Marvel of the Middle ages, and which, when all Europe was plunged in barbaric ignorance and strife, alone held the torch of learning and civilization bright and shining before the Western world."¹⁶

Colleges and libraries at such cities as Cordova, Toledo, Seville and other towns, became world renowned with the College at Cordova attracting thousands of students. Says Farmer — "Material and intellectual wealth seemed to go hand in hand. The coffers of the sultan 'Abd al Rahman II (d. 961) brimmed over with twenty million pieces of gold, whilst the library of the sultan Al-Hakam II (d. 976) contained four hundred thousand books. This latter Monarch founded twenty-seven free schools in Cordova and paid the teachers from his own purse."¹⁷

On Oriental Africa and Arabia

Previously we discussed myths and misconceptions concerning the Maghrib and North African-Arabic speaking countries in general. Further clouding common perceptions are popular images — in literature, television and film — of peoples of the Maghrib, Oriental Africa and Arabia that depict only Caucasian types with the virtual exclusion of those clearly African or of obvious African heritage.

What is an Arab? The Encyclopedia Britannica addresses this problem by saying: "any person whose native language is Arabic ... In contemporary usage it includes major segments of the population of the Middle East and North Africa and in the Americas — about 100 million in 1970." The Britannica, in reference to its affinity to Africa says: "Western Arabia formed part of the African land mass before a rift occurred in the earth's crust as a result of which the Red Sea was formed and Africa and the Arabian Peninsula became separated. The southern half of the peninsula consequently has a greater affinity with the Somalia and Ethiopia regions of Africa than with Northern Arabia and the rest of Asia. Arabia is but an extension of Africa, according to J.A. Rogers, where Black people from the southwest and white, or nearly white, people from the Northwest met to mingle their cultures and their blood. Arabia in Muhammad's time," he continues "was, even as it now is, a mulatto land."¹⁸

Professor John Hunwick, Professor of African History and Professor of

History and Literature of Religion at Northwestern University, points out that the "native language of the largest numbers of Africans (100 million) is Arabic and that it has been used in Africa as a "language of Learning" and communication "for more than 1300 years." It arrived on the African Continent with the Arab conquest of Egypt in the 7th century A.D. and mainly "through trade, and the preaching of Islam" reached other areas of the continent. He speaks of an Afro-Arab people, "united by a common tongue and by a common religion — Islam." Hunwick says this was brought about in East Africa as a result of Arab traders who from the 9th century "sailed to the coast of East Africa," islands off the coasts of Kenya and Tanzania and on the main land from "Somalia to Mozambique." The Arab merchants settled and thereafter took wives.

He points out when "Nubian rulers (upper Egypt)" accepted Islam in the 14th century it opened the door for "Islam and the Arabic language to penetrate far up the Nile valley and across the scrub and semi-desert into the center of Africa."

The Funji Kingdom of Simar on the Blue Nile (1504–1821) and the Dar Fur Sultanate (17th and 18th Centuries) used Arabic as the Official court language. The same was so of the Turco–Egyptian rule in the Sudan (1821–85). Hunwick cites over a million archival records stored in Sudan's National records office in Khartoum with all "chronicles of Sudanese history" being in the Arabic Language, the official language of that African country.

North African merchants were responsible for the spread of the Arabic language and Islam in West Africa. The lure of Gold brought Arabs and Berber traders from Mauritania to "Ancient Ghana and from Algeria to the River Niger." By the 11th century many rulers of the Sahelian Zone converted to Islam. During this time the Arabic language came into wide use in this area as evidenced "by Tomb Stones, records and other artifacts."

With the advance of the Almoravids later in the 11th century the use of Arabic and Islam was strengthened. Morocco and Spain were conquered in the North and their influence also increased in Ghana and Middle Niger to the South.

From the 13th-17th Century important African centers of commerce, Arabic studies and Islamic learning were established. They were Walata in southern Mauritania, Timbuktu in Mali, Agades in Niger and Kano, Katsina and Gazargamu in Nigeria.

"These cities," says Hunwick "became heirs to a tradition of Islamic scholarship mediated through the Arabic language which became, among the Muslim communities of West Africa, the vehicle for literacy. Later, from the 17th century a number of West African languages were to be written down in the Arabic script — notably Fulfulde, Hausa, Kanemba and Wolof — long before the Latin script was introduced by European Missionaries and colonial powers."¹⁹ (see figures 1, 2)

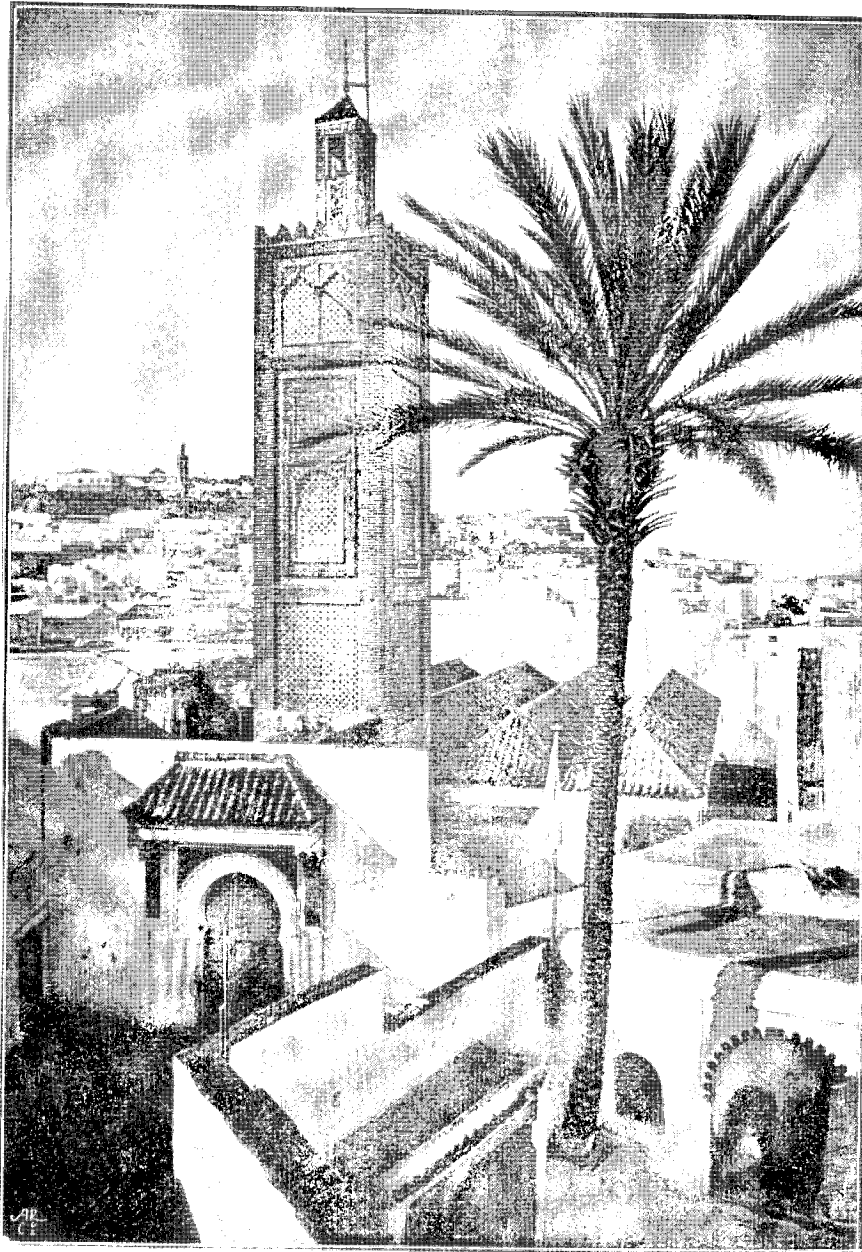

Figure 1. A minaret of Kairouin University—Fez, Morocco. In the Tenth and Eleventh Century “those thirsty for knowledge came from Niger, the Congo, Tripoli, Tunis, Egypt Andalusia and Italy.”



Figure 2. A typical student at Kairouin.

"In ancient Arabia," as J.A. Rogers points out "many of Prophet Muhammad's first followers were African. Bilal, his second convert and most honored friend, was an Ethiopian (Abyssinia). And Zayd Ibn Harith, his third convert, whom he adopted as a son and who rose up to become one of the Prophets greatest generals was also an African."²⁰

At the height of the glory of the Abbasids in the court of Haroun Al-Rashid, of Arabian Nights fame, was Ibrahim Al-Mahdi, one of the most renowned singers of that era.* He was also the half brother of the Caliph Rashid. Two Caliphs are said to have had African mothers — Al Muktafi and Rashid.²¹

"When we speak of Arabian culture, we do not mean that its *Fons et origo* are claimed for the Arabs themselves or for Arabia, but simply that this culture arose under a polity that was Arabian, and that the language by which it was propagated was Arabic."²²

Music in Oriental Africa

The most characteristic cultural tradition of the region referred to as Oriental Africa is Islamic music.²³ It extends over most of the areas of East Africa across the Mediterranean littoral, south through West Africa, to the edge of the Sahara. There are certain pre-Islamic cultural traditions that differ in how they respond musically to Islam, and they often coexist. In some areas, however, "among Blacks who moved across the Sahara to North Africa, the Islamic music is colored by indigenous elements."²⁴

Islamic influence in performances of African singers is usually identified with ornaments and "quick microtonal shakes," mordents and tense vocal quality.²⁵ Other characteristics are identified by the use of a single drum accompanying a bowed-stringed instrument, such as the rebab. "A Moslem influence," according to Malm "may be inferred if, when voices and instruments combine, the accompaniment is not the multiple drums or ostinatos on a melodic instrument as found in Central Africa." Also characteristic of the Moslem influence is the use of single rhythmic lines instead of the polyrhythms usually identified with sub-Saharan Africa.²⁶

As discussed earlier, ancient Egyptian ideas in the field of music were significant. Kebede points out that "Egyptians were one of the first to experiment with a system of musical notation. The development of music as a profession in ancient Egypt is significant in the study of African cultures in general. Schools of music were established that trained not only vocal and instrumental performance but also theory and chironomy — the Art of notation by means of gesture."²⁷

Of all the major influences that were to impact on the conquered Egyptian,

*Editor's Note: Al-Mahdi was more than just a renowned singer. On the death of his half-brother, Rashid, he became Caliph for a brief period. (see Drake, *Black Folk Here and There*, p. 122).

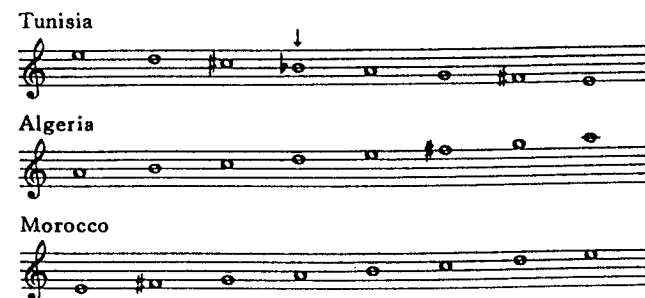

Figures 3 and 4. (Above) Berber dancers and musicians from Southern Morocco. (Below) Ramal Maia Mode, three versions.

the most significant was the Islamic invasion in the seventh century A.D.²⁸ Islamic cultural practices became firmly embedded and spread throughout Egypt and in Tunisia in the latter part of the seventh century.

In Tunisia most of the Berbers who were the original inhabitants of that Country converted to Islam.²⁹ In Morocco, where the largest Berber population is found today, *traditional* forms of Berber music have become synonymous with that culture. (see figures 3, 4)

Ashenefe Kebede in *Roots of Black Music* refers to three categories of Pan-Islamic music: (1) traditional music, (2) classical music and (3) contemporary or urban music.³⁰ Traditional music is that which is performed by the common people rather than the professionally trained musician. Classical, says Kebede, refers to that genre of music and musical performance that has been developed and advanced by specialized schools of music, transmitted to and performed by generations of professional musicians. The Andalusian Music of North Africa represents the kind of music found in this category; it is the music developed in Moorish Spain during the Middle Ages.³¹

In Morocco the black *gnawa* perform a large part of the traditional music. They are also found in Tunisia and are known among the Wolof people of Gambia as “griots.” Singers of religious songs or *gasida* songs, they are professional musicians and entertainers who accompany themselves on stringed instruments; and “integrate dance poetry and singing in their performance.”³² (see figures 5, 6)

They descend from the black *gnawa* who came to Morocco from West Africa. Many of their song texts contain references to tribal and place-names in the Western Sudan and to their experiences in the diaspora. Their musical performances are known for their ritualistic healing and snake charming ceremonies. Women often participate during the ceremonies on *bandir* (the frame-drum). An instrument called *ghaitu* (shawm) is used during the snake charming ritual.³³ (see figures 7, 8, 9, 10)

In the Wolof society there is a mixture of styles in the music. They sing praise songs in the North African tradition and this synthesis of styles may be found throughout the “fringes of the Saara.”³⁴ The musical traditions reflected in their narratives date back to the Moslem caravan routes as well as pre-Moslem Africa.³⁵

Malm discusses the Wolofs of Senegal and Gambia and their similarities and differences in musical expression. They use both cylindrical and pot-shaped single-headed drums in groups to produce African polyrhythms for their secular dances, but when their holy man sings Moslem hymns (*hasida*), a small kettle-drum called a *tabala* is used, along with an iron beater; together, these produce simple single rhythms much more akin to the music of the rest of the Moslem world.³⁶

Political organization among the Northern Tuareg societies was greatly affected by the Islamic influence. Evidence is seen in the title of Khalifa given

to tribal deputies. This title is used by the Northern Tuareg and other groups. The most important political group is the drum group. Throughout most of Africa the drum is used as an insignia of Kings. Historians say the use of the drum in this way is “pre-Islamic in Africa,” and is restricted mainly to the “Erytrea Cultures.” Among the Tuareg the drum “constitutes the insignia of a Tuareg drum-chief and is known as *ettebel*.”³⁷ Derived from the Arabic word *tobal*, *ettebel* also constitutes the name used for “Tuareg drums” and “drums of chiefs” among the Western Moors. (see figure 11)

The drums of the Tuareg chiefs are known as Kettle drums and are never used by persons other than the chiefs.

Historians note that Kettle drums are usually found in Islamic North Africa, the Sudan, and North-East Africa. In regard to Kettle drums outside Africa, Sachs says “they occur mainly in Islamic West Asia from where they were recently introduced to Europe and to India where terms for Kettle-drums are derived from Arabic.”³⁸

One of the most important musical styles found in Oriental Africa is Zajal. It is a vocal form utilizing “classical poetry set to music.” The Muwashah is another form of vocal music performed in North Africa. Usually accompanied by musical instruments, the song text is most often based on rhythmic and melodic modes. Historians debate whether Zajal and Mawashah developed simultaneously or whether one derived from the other.³⁹

Chejne describes Zajal and Muwashah this way. The Zajal often refers to that poetical composition in which a spoken Arabic dialect along with some non-Arabic expressions is used. As for the Muwashah, it is considered a more artistic production containing — except for the Kharyah or concluding verses — literary Arabic expressions only.⁴⁰

The content of the verses of both are, for the most part, identical in form and content. They differ in the choice of language since the Muwashahat make use of classical Arabic whereas the Zajal make free use of colloquial Arabic and Spanish dialect.⁴¹

The most important contribution of this new form of poetry — the Zajal and Muwashahat was that they freed Al-Andalus from the formalism of classical poetry, traditional throughout North Africa and the Near East. It was spontaneous and simple and at the same time akin to the personality and temperament of the Andalusian.⁴²

The *Nuba*, an important North African musical form, “considered a classic by the scholars” — originally meant turn. Musicians used the word to express their turn or time to perform. Ribera says “from this earliest meaning of turn, the word *Nuba* came to imply the music which each artist executed, and even the weekly musical sessions held by certain Caliphs, and, because these latter were made up to turns of the various musicians it meant later the whole of the performance.”⁴³ The *Nuba*, which became very popular in Moorish Spain, is compared to the suite in European classical music.



Figures 5 and 6. Gnawa Musicians of Morocco.

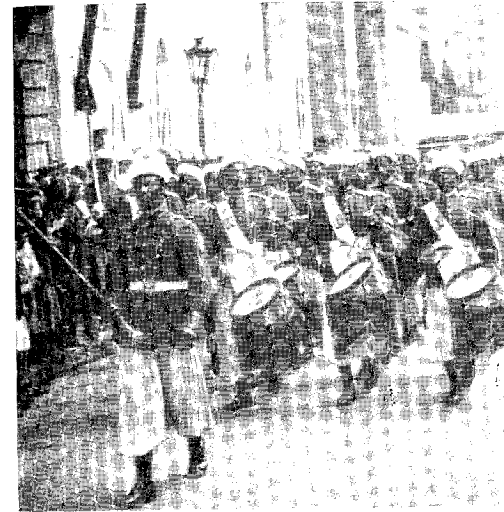

Figures 7, 8, 9, and 10. Military bandmen of the Sultan of Rabat (Circa 1952).



Figure 11. Tuareg musicians and dancers of Agadez, Ayr, in the Western Sahara.

The Nile Valley

The Sudan is a vast country which borders on eight countries. Bordering on the Nile River it has three major ethnic group populations; they are Nubians, Mahass Shaiga, and Galien. Traditional vocal music is highly developed in the Northern area, while the Western region is known for a variety of songs and dances, usually performed by female vocalists. Similar musical performances are found in the West. Instruments used for accompaniment to vocal music include the Ethiopian Krar, the Al-Kaita (Shawm, also known as *ghaitu* in Morocco and Tunisia) and various small drums. The music of the Sudan combines “both oriental and sub-Saharan cultures.”⁴⁴ (see figures 12, 13)

Ethiopia, despite its Islamic influences, remains, as far as musical culture is concerned, a reflection of its dominant religious influence, Coptic Christianity. Although the Falasha Jewish tradition is clearly a major cultural influence, and in the south we find musical expression exhibiting styles more typical of Sub-Saharan Africa, Christian Ethiopia remains the dominant musical influence.⁴⁵

Kebede in his work *Roots of Black Music* refers to an “indigenous and truly African style of music,” one, he says, that cuts across oriental Africa from north to south and east to west. The Egyptian civilization was the cradle of music. Even the Greeks referred to Egypt as the source of their musicopedagogic ideas. Nearly 2500 years ago, before Arabia was known, Herodotus commented on the Egyptian achievement in the following manner: “there is no country that possesses so many wonders, nor any that has such a number of works which defy description.”⁴⁶

Ancient Egyptian music, according to Kebede, is preserved today in the music found in the Coptic churches and is deeply rooted in the music characterized simply as Arabic. He points to the Axumite civilization at the Horn of Africa during pre-Islamic Arabia. He cites court and religious music that was highly developed and was part of a “noble heritage,” where members of the aristocracy were educated in the science of music. Today the Axumite legacy is preserved in the Hurhara music of Ethiopia.⁴⁷

He also focuses on the music of the Berbers, the native inhabitants of North Africa, whose territory stretched from North to West Africa in prehistoric times. Although they migrated North with the advent of Islam their ancient music was still preserved. The Berber style, Grame points out “has nothing whatever to do with ‘Arab’ influence but probably represents an ancient African style. It has always astonished me that the “scholarly” community is resolutely unaware of the existence of a style of African music that stems out across the continent from roughly Ethiopia to the Atlas mountains.”⁴⁸

According to these scholars and others who present data from ancient times to the present, there is substantial evidence of an indigenous musical style in that area.⁴⁹ (see figures 14–23)

The Music of Ancient Arabia

There is evidence of a South Arabian Kingdom with traces of a "high civilization," as early as the second millenium before Christ. Having much in common with Babylonia and Assyria, it contributed culturally to Greece, including some of its alphabet. Writings have been found suggesting that, long before the sixth century A.D., music systems existed among the Arabs, Chaldeans, Minaeans, Sabaeans, Nabateans and Palmyraens as well as the Lakmids and Ghassamids. In the seventh century the Arabs conquered Persia, at which time they were already in possession of a system of musical theory.⁵⁰ Some scholars argue that the Arabs studied the system of the Persians. To this Farmer says: "To say that the Arabs had no system which they were able to reduce to theory, is not in accordance with facts. We have plenty of references to music and musicians in pre-Islamic times, and it is almost impossible to conceive that these people (to whom music was almost an absolute necessity), who could systematize their poetry as we see in the mu allagat, Hamassa and Mufaddaliyat, (famous poetry) were not able to systematize their music. Fortunately, Al-Farabi has preserved for us details of a pre-Islamic system in the scale of the tambural Baghdadi, which was arrived at by dividing a string into forty parts ... While it was superseded by Pythagorean intonation in the cultured near East and Persia, as well as among the Arabs of Syria and Al-Hira, it subsisted in more remote corners of Al-Hja and Al-Yaman, and found its votaries even down to the tenth century A.D."⁵¹

Virtually all western historians wrongly credit the Greeks as being the creators of the sciences. So it is not surprising that it is suggested here that the "intonation system" of Pythagoras, considered the father of "Western music theory," superseded those of the East. But Farmer has shown that this is "the pan Grecian conceit."⁵²

Professor George G.M. James in *The Stolen Legacy* argues that, after Alexander the Great invaded Egypt, thousands of Greek scholars not only came to study at the feet of African-Egyptian teachers but ransacked the Libraries of Alexandria. Many famous Greek scholars, later given credit for Egyptian first discoveries in the fields of Philosophy and science, confiscated 5,000 years of knowledge accumulated in the temples and libraries of Egypt."^{53*}

Al-Hira was the literary centre of Arabia, "from whence poetry radiated to all parts of the peninsula." Many suggest that since music was so closely allied to poetry it was equally favored among the Arabs.⁵⁴ This center most likely possessed a considerable musical culture, seeing that the famous Persian King, Barram Ghur (430-8) was sent to the Arab Lakmid court in that city to be educated, and here he was taught music among other Arabian accom-

*Editor's Note: The 'Arabs' were also to build upon this Afro-Egyptian legacy, although they assumed, since much of it had been translated into Greek, that they were merely transmitting, and extending upon, the Greek.



Figures 12 and 13. Nubian musicians playing the flute and Oud (lute).

plishments.⁵⁵ Farmer finds it strange that Persia should need to send students (their young sovereign himself) to study the "Arabian musical system." It suggests that Persia was so lacking in professional musicians that they had to be imported, particularly since this was before the Arabs had conquered the Persians.⁵⁶ But scholars differ on this account. For instance, Ribera in *Music of Ancient Arabia and Spain* says that pre-Islamic poetry is considered classic among Arabs, but did not happen to be accompanied by music.⁵⁷ Says Ribera: "The musical historians tell us that, until the death of Muhammad, Arabic Songs were of so primitive a type that they did not even possess rhythmical elements, but were simply a kind of monotonous chanting with which the camel-drivers urged on their beasts during the desert voyages. Although we owe most of the early song-words to poets of the Arab tongue, the music was composed and executed by foreign musicians. The explanation is that the title of poet was considered an honor, while to be a musician was considered demeaning."⁵⁸

Ibn Khaldun in the *Muqaddima* says that "musicians from Persia and Byzantium passing into Al-Higaz playing upon the lute (ud), pandore (tambur), and other instruments were responsible for the Arabs utilizing Persian and Byzantine melodies and adopting them for Arab poetry."⁵⁹

The specialist in oriental musicology, J.P.N. Land, makes it clear, however, that "the Persian and Byzantine importations did not supersede the national music, but were grafted upon an Arabic root with a character of its own."⁶⁰

"Further, so far as extant treatises are concerned, the early Persian work on music dates from the twelfth century, whilst we have Arabic treatises on music which date from the ninth century, and we have evidence of works even dating from the eighth century."⁶¹

Arabic music reached its zenith during the eighth and ninth centuries with documents still today existing of works by musicians whose chronicles "make a record unequalled perhaps by any European nation."⁶² Al-Isfahani's *The Book of Songs* describes in detail, the history, and chronology of the spread of Arabic music including singers and musicians.⁶³ The vast knowledge attributed to Arab scholars which in turn was passed on to medieval Europe came as a result of the following.*

In the seventh century the Arabs became masters of virtually half of the "then known civilized world," and it was in Byzantium and Persia that "vestiges" of the literature of ancient Greece (and unacknowledged loans from Egypt)* was found and confiscated by the Arabs.⁶⁴ Greek books on science and Philosophy were gathered from the monasteries and libraries there. With the cultural and political stagnation of Byzantium and Persia that had

come about during that time, "if it had not been for the zeal of the Arabs in this direction, many of the works of ancient Greece would not have come down to us."⁶⁵ By the eleventh century the Arabs were able to "translate from the Greek many musical treatises hitherto unknown to Western Europe." Included among these were Aristoxenos ("Harmonics" and "Rhythmics"), Aristotle ("problems"), Euclid ("Harmonics" and "Canon"), Ptolemy ("Harmonics") and Nikomachos ("Harmonics").⁶⁶

As a consequence music was recognized as one of the courses of scientific study, as is found in the writings of Al-Kindi (d.c. 874), Al-Sarathsi (d. 899), the Banu Mosa (ninth century), Thabit ibn Qurra (d. 901), Muhammad Ibn Luga (d. 932), Al-Farabi (d. 950), the Ikhwan Al-Safa' (tenth century), Muhammad Ibn Ahmad Al-Khwarizmi (c. 980), Ibn Sina (also known as Avicenna (d. 1037) and Al-Husain Ibn Zaila (d. 1048).⁶⁷

Although music continued to exert influence with the advent of Islam (Seventh century) a major change occurred in its "social function." This was due to religious conservatism.⁶⁸ Traditions citing music as unlawful include: "Iblis (Satan) was the first who wailed and the first who sang" ... "no one lifts up his voice in singing, but Allah sends two devils to his shoulders." "Music and singing cause hypocrisy to grow in the heart as water makes corn grow." Another proclaims that songs sung by women along with stringed instruments are apocalyptic and certainly a vehicle by which man is seduced by Satan.⁶⁹ Conversely, there are religious traditions condoning music. One example should suffice: "Allah has not sent a prophet except with a beautiful voice."⁷⁰

Nevertheless, music was considered undesirable by the law-makers, and sanctions were imposed on the singers and players. Muslim authors soon began to seek out ways to reconcile the contradictory situation. Among them were Ibn Abd'Rabbihi of Cordova and Ibn Khaldun of Tunis, who wrote on the negative and the positive.⁷¹

The most celebrated singer of the early Islamic period was Tueis (also Tuwais). He is said to be the one who introduced rhythm into Arabic music. He accompanied himself with tambourine on songs in the hezej and ramel rhythms. Other notable musicians of this time were Addolal, Hit, Saib Khater, Nashet. As the teacher of Ibn Suraj and Mabed "Nashet a Persian had great influence among Arab musicians. Ibn Mosayeh was the singer who introduced the greatest number of new melodies. Ibn Suraj was one of the greatest of the founders of Arabic music."⁷²

A story is related regarding the singers Ibn Suraj, Al-Garid and Mabed. It is said that an Emir visiting Mecca when the three were there wanted to banish all singers. Angry at the ruling the singers gave a public concert. Mabed began to sing, and stirred the audience profoundly. Next Al-Garid sang, and there was a general lament. At last came Ibn Suraj, who stirred up such a tumult that the whole city caught the contagion, and hastened to the Emir to have the order revoked.⁷³

*Editor's Note: Professor Ali uses the word Arab in this broad context to cover practically all Muslim peoples speaking Arabic. Also, as he has previously pointed out, and it needs to be re-emphasized, the Greek musical treatises are not simply the work of the Greeks.

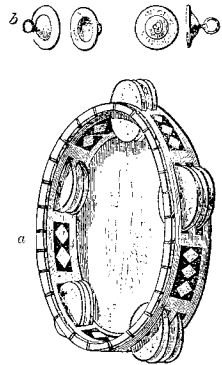
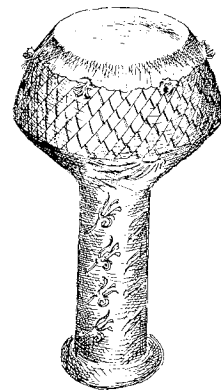
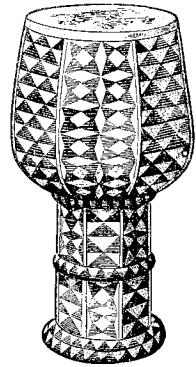

Figure 14. Darabukkeh.

Figure 15. Tombak or darbuka.

Figure 16. (a) Tar (Tambourine); (b) Sagat (Castinets).
Musical instruments of Oriental Africa and Arabia.

The women singers who were the most distinguished were Izato-l-mila and Jamila. The former was given her name because of her graceful gestures and movement in walking, and was said to be very beautiful with amicable manners, graceful conversation and great elegance of style in her expression.⁷⁴

Three other musicians should be mentioned among "the great generation of artists who laid the foundation of Arabian song." They are Ibn Moris, Mabed, and Malik. Ibn Moris, a disciple of Ibn Masajeh, was the first to set pairs of verses to music. It was soon copied by those musicians that followed him.⁷⁵ The renowned Mabed, an African, was a pupil of Saib Khater and Nashet. He was a composer and great singer. He was a brilliant teacher who trained many famous singers.

Mecca and Medina were the musical centers and there were no singers of great fame found elsewhere. "The first artists flourished in the regions about Mecca and Medina because in these cities dwelt the Arabian families of wealth and lineage, who mustered there the sumptuary arts and other elements of culture belonging to their conquered neighbors ... Thus Arabic music was born not by spontaneous generation nor by lyric exaltation of individuals ... The melodic material was drawn from ancient civilizations, and was selected according to popular taste and presented by intelligent professionals."⁷⁶

Bilal The Abyssinian

A historic figure with a magnificent singing voice emerged during the time of Prophet Muhammad, whose place in history would forever be endeared among Muslims. His name is Bilal Ibn Rabah, the first caller (mu-athen) to prayer in Islam. Born in Abyssinia (Ethiopia) he was a former slave. But Omar Ibn Al-Khattib, the second Caliph in Islam, the leader responsible for "completely destroying the throne of Persia and reduced to shambles the foundation of the Byzantium empire, described Bilal as "our master." To Muslims his name personifies endurance, sacrifice and determination." According to Wayne Chandler, "Bilal was the prophet's closest friend, who in the hereafter was chosen by the prophet to protect him."⁷⁷ It was the voice of Bilal that was used to call the "Faithful" to prayer.

Bilal had been a slave to Umayyah Ibn Khalaf and, having been born in Mecca to a slave mother, would probably have remained a slave. But upon hearing of Muhammad and the new religion (Islam) he professed desire to hear more about Muhammad and the "revolutionary qualities of this new religion" (Justice and Equality). When his Master (of the Quraish leadership) heard he had embraced Islam, "he was savagely beaten" in an effort to force him to abandon it. Bilal was taken to the desert, laid naked upon burning stones and covered with a large rock which was carried by several men. He

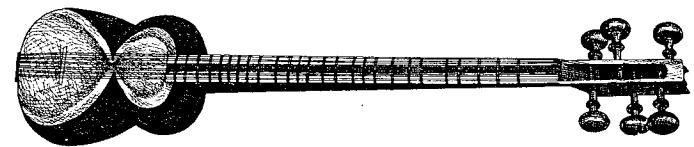
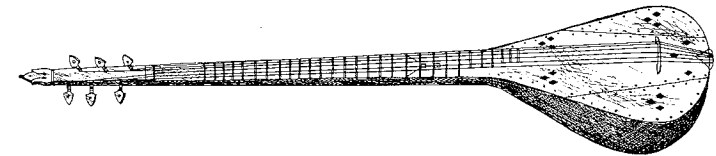
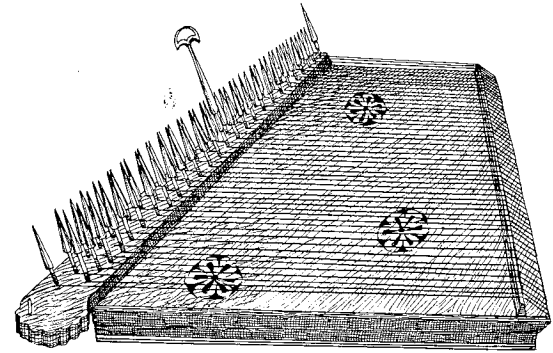
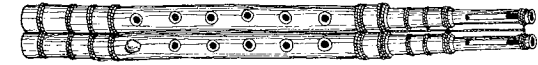
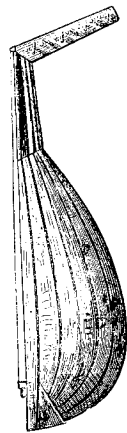
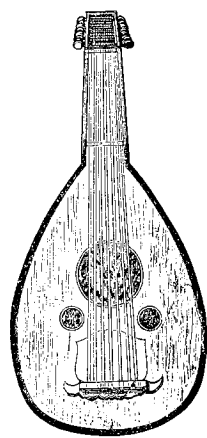

Figure 17. Zurna.
Figure 18. Al-Oud.

Figure 19. Yarl.
Figure 20. Kanun.
Figure 21. Tambur.
Figure 22. Tar.



Figure 23. Musicians playing in Cairo cafe on the Rebab (right) and Kemendjah (left).



Figure 24. Eastern Rebab Player.



Figure 25. Muezzin's call to prayer in the tradition of Bilal of Abyssinia.

was told to renounce the "one God" (Allah) and mention the idols Al-Laath and Al-Uzzaa.

Repeatedly asked to deny his newly found religion Bilal only uttered Ahad – Ahad – (God is one). In the evening he was led by children through the streets of Mecca with a rope around his neck, then taken back at night so they could "bargain with him." Lasting for days, the torture only brought the same words to the mouth of Bilal "Ahad ... Ahad." When Prophet Muhammad's closest companion, Abu Bakr (first Caliph of Islam) heard of this, he went to Umayyah and paid him a large sum for his release. Ali Baghdadi, who narrates the story of Bilal's life, tells us how Muhammad was very pleased to see Bilal free for the first time in his life. After the migration of the messenger and his followers to Al-Madinah he asked Bilal to be the first *mu-athen* in Islam, whose duty was to call the faithful to prayer five times daily.

When the War broke out between the Muslims and Quraish, Bilal took part in this first battle in Islam, the battle of Badr. In Bilal's honor, Prophet Muhammad chose Ahad ... Ahad as the slogan of this great battle. Together with Muhammad, Bilal participated in all battles in defense of Islam. When Muhammad and 10,000 Muslims marched into Mecca eight years later as victors, the prophet, accompanied by Bilal and other dedicated companions, went to Al-Ka'abah, the Holy Temple built by Abraham, and destroyed all the idols. Bilal climbed the wall of Al-Ka'abah, the most sacred shrine in Islam, and with a beautiful and solemn voice he called the faithful to prayers. Thousands of Muslims repeated after Bilal. "God is the Greatest ..."

Upon the death of Muhammad, Bilal made a request of the Caliph (Abu Bakr) to allow him to continue to "struggle in the path of Allah." But Abu Bakr wanted Bilal to remain in Medina and continue to call prayer. Bilal replied: "If you freed me to become your own slave let it be so. However, if you freed me for the sake Allah, let me go to him." His wishes were granted and he joined the "Soldiers of Allah" whose mission at that time was to liberate Syria from Byzantine oppression and domination. Bilal made his final call to prayer when he visited Omar (the second Caliph of Islam) in Syria. He later died in the city of Damascus, fulfilling the promise Muhammad made, that he was "a man of paradise." It is said that Bilal had longed for the day when he could join the Prophet Muhammad in the House of Eternity.⁷⁸

The Classic School

The musicians who most personified the "classic spirit of Arabic music" of that time were Ibrahim Al-Mosuli and his son Ishak.⁷⁹ They were the most renowned musicians in the court of Harun al-Rashid. Born of a Noble Persian family in Kufa in 740 A.D. (125 of the Hegira) Ibrahim lived for a time in Mosul (from which he took his name). In his early days he travelled "about

the most distant countries and mastered Persian and Arabic song." He gathered popular songs in the town of Medina, says Ribera and sought information about old Arabic music throughout the Hejaz through conversation with aged persons, thus acquiring such universal technical knowledge that there was no type of music which he did not know and utilize."⁸⁰ It is said that each of the older singers had only specialized in one style, "one in Allegro, another in slow movements." But Ibrahim Al-Mosuli, his son Ishak, and Ibn Suruj used all the styles; and they were "the only ones." Ibrahim's compositions were said to number nine hundred: "three hundred of superior merit; three hundred of average value, like those of ordinary composers; and three hundred of little worth."⁸¹

According to Agani—"one was so outstanding as to be comparable only with the three best works of earlier times: one by Hakam, one by Felih, and the third by Sayat."⁸²

Ibrahim Al-Mosuli followed strict rules and standards of musical composition; and as such was an "exemplar of classic taste." Like all serious musicians he did not hesitate to criticize personal liberty on the part of the "executant who deviated from these rules."⁸³

An example is given of his masterful musicianship, keenness of ear, and scrupulous tuning. When the singer Ibn Jami paid a visit to Ibrahim one day, thirty female musicians were brought out to entertain him. They sang, accompanying themselves in one mode only. "Ibn Jami noticed that among all the lutes (Al-oud), one string was out of tune. Ibrahim, noting it also, said to the girl with the ill-tuned lute: "Tighten the second string of your lute." She complied, and thereafter all went well "showing that, while Ibn Jami could ascertain that one string was off pitch, Ibrahim could detect the exact string."⁸⁴

Ibrahim was a teacher of many pupils, among whom was his son Ishak. Many musicians studied with him and received the highest prices in the market when they had received a thorough training from Ibrahim; as a consequence he amassed fabulous wealth counted by millions of silver coins.⁸⁵

Ishak, his son, did not have the voice or other qualifications of his father but excelled in "musical erudition and technical knowledge." Like his father, his technical knowledge did not come from books but was derived from observation, experience, and "direct investigation of music as it was then performed."⁸⁶ He had not only great knowledge of music. He knew the old songs, from those of Tuis or, with the ability to distinguish all the melodies and artists "better than anyone else."⁸⁷ One historian describes Ishak as one of the greatest musicians in the annals of Arabian music.⁸⁸ He was a pupil, not only of his father but two other famous musicians of that time, his uncle Zazal and Atika Bint Shudha. In addition to being a great musician, a poet, litterateur, philologist, and jurisconsult,⁸⁹ he had one of Baghdad's largest libraries said to be "rich in words on Arabic philology from Ishak's own hand." Some forty works were written by him, and seventeen of these concerned music or

musicians."⁹⁰ Although none of these "later works" have been discovered, according to Yahya ibn Ali (d. 912) "Ishak was the most learned of the people of his time in music, and the most accomplished of them in all its branches, and the best performer on the *oud* and most of the other instruments of music."⁹¹

Unlike earlier critics, who classified melodies solely according to rhythm, he went into more detail of tune and tempo and also into the determination of the fundamental notes of the accompanying instrument, what we would call today the key or "harmonic basis of the accompaniment with its possible combinations."⁹² He is said to be the one who introduced the use of falsetto, or male soprano register. It proved to be "best adapted to his voice," for although his artistic skill was unmatched his natural voice was said to be inferior. Of course, because of this, his fan's admired his own songs more when they were sung by other musicians.⁹³

An illustration accompanying this essay shows Ibrahim Al-Massuli playing on a falsely tuned lute "without the listeners noting the fact." This demonstrates something which all who have musical experience recognize. And that is that musicians "using equal temperament" and familiar with transposing, can make a transition into "any required key." So the lute players, like the pianists of today, "due to tempered pitch," transposed, used sharps and flats, realizing that "any note may become the keynote of a diatonic scale."⁹⁴

Naumann says: Ambros asserts that the Arabians had no knowledge of harmony. This is an assertion to which I cannot assent, great as my respect is for the judgement of so learned a musical historian. Such an opinion would seem to be contradicted by the favorite practice of Oriental, and especially the followers of Islam, viz., that of adding a kind of pedal bass to their melodies. This practice is still prevalent in the East. Besides, their accompanying instruments could not have been used merely for strengthening the melody, but evidently had, and have still the object of sustaining the melody by chords, *arpeggio* or otherwise.⁹⁵

Historians debate over the character of early Arabic music, in terms of its harmony, rhythm and expression. Some believe it was always in unison, "but there are strong indications that it was already harmonic."⁹⁶ Use of instruments similar to organ and bagpipes that sounded simultaneously suggests they must have been "harmonically related." Songs of this period are described by historians using "Al-Mosuli's classifications," that is, "according to their technical attributes": (1) rhythm (2) fingering ("position on the neck of the lute") (3) "alternating use of principal note in combination with a secondary one." We can put this last classification in better perspective by proposing that a mode or scale was used harmonically. And that it "indicated the use of fundamental notes of what we now call chords."⁹⁷

According to Ribera, "The scale then in use also inclines one toward a

belief in the existence of harmony in Arab song. This scale was never explained by the learned as being composed of tetrachords or hexachords but simply as octaves, and this division is essentially harmonic."⁹⁸

**Abu Hasan Ali Bin Nafi (Ziryab)
The Cornerstone of Spanish Musical Art and the
Andalusian Lyric metric system**

Generally the "musical traditions of the East" passed on to the west and, in spite of the conservatism of religious scholars, became part of Andalusian culture.⁹⁹ At first, religious law imposed sanctions on music and musicians with penalties for selling books on laments about songs. According to these same laws in the books of Spanish Moslem justice, it was forbidden to rent a house if flute or bandola playing was intended within. The public authorities were to punish infractions of the religious law, and zealous judges complied with the law to the extent of ordering the destruction of instruments found being carried through the streets. However, in the end, just as in the Orient, musical art survived and spread through Al-Andalus.¹⁰⁰

The first Omayyad ruler Abdu'r-Rahman I kept singers in his court. Among the outstanding singers were Ajfa brought from the Orient. Al-Hakam I, during his rulership also brought to his court many celebrated singers including "Alon and Zarcon who sang with great art and whom he paid lavishly."¹⁰¹ Male and female singers arrived from the east during the reign of Hakam I. Others included Alwan and Fadl Al Madinah, who were born in Al Andalus and received musical training in Baghdad and Medina. We may add Qamar, famous for composing melodies at the court of Seville.¹⁰²

Abu'l-Walid from Alexandria in Egypt was brought to the court of Abdu'r-Rahman II. Described as young and elegant and one who "shone at the court of the Emir," it was said of him that he would have dedicated himself to music if he had not taken the advice of Isa bin Shahid, Chancellor of Abdu'r-Rahman II, who counseled him to leave this profession so as not to be hindered in rising politically.¹⁰³

But the singer whose fame eclipsed all others was the distinguished musician Ziryab who arrived in Al-Andalus in 822 A.D. Born in Mesopotamia in 789 A.D. his real name was Abu-l-Hasan 'Ali Ibn Nafi but he was known as Ziryab (the Blackbird).¹⁰⁴ It was an appellation given to him by the people of his native town because of his black complexion, the eloquence and suavity of his speech and the amiability of his temper. (Zaryab being the name for a very rare and valuable bird of dark plumage which is to be found in that country, and has a very sweet note; also *Zaryab*, *Zeryab*, or *Zariyab**).¹⁰⁵

*Editor's Note: Readers should not be confused by the different spellings of this black musician. Ali spells him as "Ziryab" but since he is quoting from Al-Makkari, whose spelling is "Zaryab," his two spellings are interchangeable.

The occasion of Ziryab's (or Zaryab) coming to Andalus is related by Al-Makkari. Zaryab was the pupil of Ishak of Maussal. Ishak was the famous musician, as you will remember, who lived in Baghdad during the reign of Harun Al-Rashid. Under this celebrated professor, Zaryab learnt music and singing. He soon made such progress and displayed so fine a voice, united to a good ear and exquisite taste, that he shortly surpassed his own master, and all the people of Baghdad gave his songs preference over those of Ishak. However, his master seemed not to be aware of his pupil's superiority until the Caliph sent for him and asked him to introduce him to a fine singer and good performer who was not yet known. Ishak mentioned Zaryab, his pupil, and spoke of him in these terms: 'He is a freeman of thy family; I once heard him sing in so tender a strain, and with so much soul, that I did not hesitate to take him with me, and make him my disciple; he has since very much improved, and whatever he knows he owes to me, who found out his talents, and brought them to light: so great has been his improvement under my discipline, that I have predicted that he will live to be a famous musician.'

"That is the very man I want," said the Caliph "bring him here to me and I will tell him what I want him for." Zaryab accordingly appeared before Al-rashid, who was very much struck with the sweet melody of his voice even in conversation and his excellent pronunciation. "What are thy performances in music?" the Caliph asked "Dost thou know how to sing a song?"

"Yes, O prince of the believers!" answered Zaryab. "I approve of what people like: but I like many songs which the people do not approve of. I feel confident, however, that thou wilt like them, and if thou give me leave to sing thee one which I have reserved for thee, and which no ears have ever yet heard, I am sure thou wilt be pleased." Immediately Ishak's lute was sent for but when this was presented to him Zaryab said, "Pardon me, O prince of the believers! but I have a lute of my own hands, and finished according to my method, and I never play any other instrument; if thou allow me I will send for it; it will be found at the door of thy palace."

This request being readily complied with, Zaryab's own lute was produced. But no sooner did Al-rashid cast his eyes on the instrument, than, seeing it entirely like that which Zaryab had refused, he could not help remarking, "What made thee refuse to play on thy master's lute?"

"Please your highness," replied Zaryab, "had the prince of the believers desired me to sing one of my master's songs I would have made use of his instrument, but since it was my lord's pleasure that I should sing one of my own composition I had no choice but to play on my own lute."

"What difference is there?" asked Al-rashid, "between thy instrument and thy master's? For me, I see none: they seem to me perfectly alike."

"So they are, in appearance," replied Zaryab, "but they are very different in voice; for although mine is equal in size, and made of the same wood, yet the weight of it is greater by nearly one-third, and the strings are made of silk, not

spun with hot water, while the second, the third, and the fourth strings are made of the entrails of a young lion, which are known to be far superior to those of any other animal in point of strength, deepness of tone, and clearness of sound; besides, they will bear much longer pulsation without being injured, and are not so easily affected by the changes of temperature." Al-rashid was delighted with Zaryab's explanation of his instrument; he ordered him to sing, and, having tuned his instrument, Zaryab tried it, and began the following song:

"O thou fortunate king, born under a happy star! men come to thee morning and evening." No sooner had Zaryab finished this first verse than he was interrupted by Al-rashid, who began to repeat the air, and said to Ishak "By Allah! were it not that I consider thee a veracious man, and that I believe that the talents of this youth were entirely unknown to thee; were it not for his protestations that thou has never heard this song from him. I would have thee punished immediately for not acquainting me with his abilities."

Upon hearing these utterances from the Caliph, Ishak subdued by envy, regretted ever having mentioned the name of his pupil. He soon summoned Ziryab and is reported to have said to him: "O Abu-I-hasan! hear my words. Envy is one of the basest vices, and yet one of the most common in this world, and principally among people following the same profession. It is in vain that men struggle against it; they never can conquer it. I cannot but confess that I am myself the victim of its attacks. I feel envious of thy talents, and the high estimation in which thou art held by the Khalif; and I see no way to free myself from it unless it be by depreciating thee and denying thy abilities; but in a short time hence thy reputation will increase, and mine will gradually vanish, until thou art considered my superior by everybody. This, by Allah! I will never suffer even from my own son, much less be the instrument of it. On the other side, thou art aware that if thou possess any abilities, it is all owing to my having taken care of thy education, and fostered thy talents; had I not taught thee all my secrets, thou wouldst never have arrived by thyself at thy present eminence. I have, therefore, to propose to thee two expedients — either to leave this country immediately and go and settle in distant lands, whence the fame of thy name may never arrive here — or to remain in this city against my will, living upon thy own resources, having me for thy implacable enemy, and being in perpetual fear and anguish at my enmity. If thou decide for the first, and engage thy word never to return to this country as long as I am alive, I promise to provide thee with every necessary for thy journey, and give thee, besides, whatever sum of money and other articles thou mayest ask from me; if, on the contrary, thou resolve upon staying, beware! I shall not cease one moment attacking and harassing thee with all my might, and I shall spare no trouble or expense to obtain thy perdition; nay, I will risk my life and my property to ensure it. Now consider, and choose."

Ziryab departed from his mentor and teacher and decided to leave the

country. Ishak, keeping his word, provided him with everything necessary for his journey. He then gave him a very considerable sum of money, and Zaryab took his flight, leaving his master.

Finally, when one day Al-Rashid, upon hearing a song by Ishak, remembered Zaryab and inquired about him, Ishak said: (without appearing at all disconcerted), " 'who does the prince of the believers mean? that insane youth who pretends to hold conversation with the Jinn, and to learn his songs from them? Who thinks that he has not his equal to this world, and that the gifts of the Khalif are to be poured profusely upon his head? Well, some time ago he took it into his head to forsake the path which promised him so many advantages; he conceived a dislike to his profession, he began to despise that which would have been a source of honor to him, and he quitted me without telling me whither he was going; and this I consider quite providential for the prince of the believers, since he was of late subject to attacks of insanity, during which his expressions were exceedingly furious, and his manner so violent that he terrified all those who looked at him.' Al-Rashid seemed satisfied with this explanation, and never afterwards inquired about Zaryab."¹⁰⁶

Upon arriving in the West, Ziryab (referred to in the above story as Zaryab) wrote to Al-Hakam I, the ruler of Spain at that time. After informing him of his talents Al-Hakam was delighted and invited Ziryab to Andalus. After arriving in the West with his family Ziryab received news that Hakam had died. Ziryab considered turning back to Africa but was persuaded by the greeting encourage sent by the Caliph not to return. Shortly after, he received a letter from Abdur-Rahman II, son and successor of Al-Hakam, inviting him to Cordoba along with additional emissaries and provisions.¹⁰⁷

Upon arriving at Cordoba he was given lodging at one of the best houses which had been prepared with all essentials including many gifts. Three days later he was invited to see Abdur-Rahman and was promised an honorarium in writing. It included 200 dinars per month for himself, 20 dinars a month for each of his four sons, plus 3000 dinars annually — one thousand on each Muslim festival and 500 additional on two other special celebrations. Also, 200 measures of barley and a hundred measure of wheat, not counting various orchards and farmhouses valued at 40,000 dinars. After all of these arrangements, Ziryab was invited to "frequent the palace" of Abdur-Rahman as his table companion, so that his "singing might be heard."¹⁰⁸

Ziryab became the cornerstone of Spanish musical art. It is said that his most profound contribution to the art of music was in the field of instruction. In Cordova he founded the first conservatory of music. The curriculum consisted of three stages: (1) the study of rhythm, metre, and singing to the accompaniment of musical instruments; (2) the mastery of melody; and (3) an introduction to Zaidah (gloss). His method of training singers was to have a potential student sit on a round cushion called masurah, and then have him exert the full power of his voice. If the voice was weak, the student was made

to tie a turban round his waist. If the aspirant stammered or was unable to open his mouth, or if he clinched his teeth, he was told to put inside his mouth a small piece of wood three inches in width, which was to be kept there day and night until his jaws were expanded. Then he was bade to utter at the top of his voice *Ya hassam* or *Ah!* If the sound was clear, powerful and sonorous he was admitted among his students.¹⁰⁹

He also invented a plectrum made of eagle quill instead of the wooden one most often used. Al-Makkari says — “He was deeply versed in every branch of art connected with music; and was, moreover, gifted with such a prodigious memory that he knew by heart upwards of one thousand songs with their appropriate airs.”¹¹⁰

Before Ziryab the lute (oud) was composed of four strings “which answered to the four elementary principles of the body and expressed the four natural sounds.”¹¹¹ He added another red string and placed it in the middle which considerably improved the sound; made it more harmonious. Al-Makkari describes the arrangement as follows: “the treble or first string, which was dyed of a bright yellow, supplied in the lute the place of the bile in the human body: the next string to it, which was red, supplied the place of the blood; it was twice as thick as the treble, on which account he called it *muthanna*, i.e. double: the third was left undyed, and was consequently white, being intended as a representative of the phlegm in the human body; in size it was double the *muthanna* or second string, for which reason it was called *muthallath* or triple: the fourth, which was black, was intended to occupy in the instrument the same place as the black humors in the body of man; it was also called *bam*, and was the largest of all; in thickness it was double the third string. These four strings answered completely to the four natural sounds, harmony resulting from the balance of their opposite properties. The *bam*, being hot and dry, was opposed to the *muthanna*, which was hot and damp, and thus a balance was produced; the *Zeyr*, being hot and dry, matched the *muthallath* which was hot and damp; so that every nature met with its opposite property until it was balanced, and the equilibrium was established. As in the body of man, by the counteraction of the contrary elements of which it is composed.” By the side of the string representing the blood, Ziryab added a fifth string to represent the soul; placed in the middle under the *muthallath* and above the *muthanna*; thus supplying the place of the soul in the human body, and improving the four notes of the lute.¹¹²

Known as the “theory of humors” it was believed by Arab medical practitioners during the middle ages that everything in the human constitution was regarded as part of a “labile equilibrium” of different forces. Humoral medicine was a common practice as an aid to surgery by Arab physicians, who believed surgery should only be attempted as a final solution. So the task of music is to “restore the equilibrium of the soul the same way that medicine restores the equilibrium of the body humors.”¹¹³

Ziryab’s accomplishments transcended the field of music. More than just a musician, Ziryab became Jan Read informs us the fashionable arbiter of taste in ninth century Cordova.¹¹⁴ Al-Makkari almost bursts into song when he speaks of him. “Ziryab moreover, was fitted with so much penetration and wit; he had so deep an acquaintance with the various branches of polite literature; he possessed in so eminent a degree the charms of conversation, and the talents requisite to entertain an audience, he could repeat such a number of entertaining stories; he was so acute and ingenious in guessing of the wants of his royal master, that there never was either before or after him a man of his profession who was more generally beloved and admired. Kings and great people took him for a pattern of manners and education, and his name became forever celebrated among the inhabitants of Andalus.” Many of his innovations were accepted in Andalus. For example, before his arrival in Spain, men and women wore their hair parted in the middle and falling on both sides, covering the eyebrows. However when people of fashion saw Ziryab, his wives, and sons wearing their foreheads uncovered, with the hair trimmed leveled over the eyebrows and slanting toward the ears, they imitated him. Many customs in perfumes, clothes, cooking and the use of crystal tableware originated with this musician. His dinners became the fashion of Andalusia.¹¹⁵

He taught the inhabitants of Andalus to “extract murtak from the murdasang or lithurge” in order to remove the smell of the arm-pits, and for other purposes. He changed the procedure for washing clothes. Before, the rulers had their garments washed in rose water and garden flowers, the result being they never looked clean. Ziryab showed them how to use salt, “mixed with the above,” consequently “the linen was made clean and white.” He was the first to gather and eat asparagus which had been unknown before his arrival. A dish called at-tafaya, made of force-meat balls and small triangular pieces of paste, fried in oil, was also an invention of Ziryab’s. Today a fried dish resembling this in Andalusia bears the name *takalliyah Ziryab* (the fried dish of Ziryab).¹¹⁶

In addition, he instructed the people of Andalus to use vessels of crystal instead of gold and silver; sleep on a soft couch of prepared leather instead of cotton blankets; dine from small leather trays rather than wooden tables (because it was easier to clean, to rub out dirt from leather than from wood).¹¹⁷

The tradition of changing clothes according to seasons of the year was another of his improvements.¹¹⁸ He suggested wearing certain garments in the season intervening between summer and winter (spring) and likewise other garments to be worn towards the end of summer and the beginning of autumn. Before, for the most part, clothing was only changed twice yearly.¹¹⁹ Jan Read reports: “A vogue for brightly colored clothes began with the arrival from Baghdad of the musician and singer Ziryab, sometimes described as an Arab Beau Brummel, during the reign of Abdu’r-Rahman II. He started fashions for

the different seasons: light silk robes and vivid colors for the spring; white from the beginning of June until the end of September; and quilted gowns or furs for Winter.¹²⁰

He even revolutionized the style of eating, introducing recipes from the Orient; "and henceforth food was no longer served in one mass, but as separate courses, beginning with soups, continuing with entrees and meat and finishing with desserts made from nuts, honey and compote of fruits," very similar to dishes popular in Spain today.¹²¹

Many were jealous of Ziryab. One Spanish poet, Al-Ghazzali, offended by the prestige of this singer, unleashed inventions and satire against Ziryab until the Caliph Abdur-r-Rahman ordered him to cease. Some of the employees of the exchequer were opposed to paying out of the public funds, 30,000 dinars, the sum which Ziryab was once paid. But, in general, even among top officials his name was remembered as that of an artist of proverbial fame, whose music and teaching really formed the traditional Spanish school.¹²²

According to historian Ibn Khaldun, the legacy Ziryab left to Spain was treasured for centuries. Adherence to his musical tradition was widespread in Seville, and, when decadence finally set in, it spread into Africa and Almagreb where some traces were still found in the fourteenth century.¹²³

The school of Ziryab took root in Spain, thanks to his many followers, and most of all members of his family. He had ten children, eight boys and two girls. Everyone adopted the art of music. Ziryab's songs were carefully collected and preserved by Aslam bin Abdul-l-Aziz. He knew all of Ziryab's songs as well as their history and classification, and could perform them. He consequently made an impressive collection which was later popularized.¹²⁴

The "oriental" school of music became acclimated in Spain, due to the presence of musicians from the East who introduced it in early times. Also, because these musicians continued to migrate to Al-Andalus throughout the period of Moorish domination, the influence in poetry, rhythms and melodies was constant. But the Andalusians were not content to passively execute this music just as it was imparted. Many composers did original works.¹²⁵

Included were Abdul-l-Wahab, considered "the most distinguished authority of his time in matters of fine singing, a man of great knowledge and an eminent poet with great nobility." He wrote poems and set them to his own music, works of "great merit and originality." Whenever singers came from the Orient they were told to meet Abdul-l-Wahab and were subsequently received, entertained and given presents and garments.¹²⁶

The new music brought into Al-Andalus from the East evolved differently than it did in its place of origin. In the "Orient" musicians were usually born and bred in humble surroundings. They were paid and applauded by the populace, and of necessity composed in forms that were simple and of the people. However, when the focus of composition shifted to the courts of Baghdad, with music as a "spectacle of palace life, paid for by Kings and

potentates of the courts," it began, according to some critics, to become "decadent."¹²⁷

Even though it was brought into Al-Andalus through palace artists, it was eventually restored to a new simplicity and freshness by the common people. Social and political changes¹²⁸ after the reign of Abdur-r-Rahman II led to a music partly affected by this "palace style" but inspired deeply by a new "national" spirit. A blind poet, Mocadem bin Mafa, from the town of Cabra, became very popular with songs of a "national" character. Mocadem's poetry utilized the metrical system based on the familiar style that "the public could sing." The new system, although it grew out of the classic Arabic style¹²⁹ was different from it in that "the verses in the Arabic system consist of two hemistichs, every pair throughout a given figure using one rhyme, and all having the same metrical pattern." The new popular system, however, was without hemistichs, and had short rhymed lines that varied in length with various rhythms. At the same time it adhered to a strict pattern indicated by the popular refrain which was the foundation of these compositions and the essence of the system. This form was simple, a pair of lines for the refrain and a quatrain for the stanza, thus: aa, bbba, ccca.¹³⁰ Other poets followed Mocadem and he was widely imitated.

The one credited with bringing the Andalusian metric system to "its greatest perfection" was Ubada bin Ma-As-Sama. He corrected bad habits of the poets who used this system and "introduced greater variety into the rhyme patterns." They included Muwashahs with refrain and stanzas, extending to ten and eleven syllables; so those of ten, abab, cdcdcdabab (five stanzas), those of eleven, abcde, fgfgfgabcde (five stanzas). The kind of poetry demonstrated became very popular because of its elegant artistic combinations; and this can be credited to Ma-As-Sama's compositions which he introduced and which "supplanted the poems of his predecessors." Consequently, in Al-Andalus in the eleventh century A.D. a lyric system of Zajals and Muwashah was invented, encompassing "every complexity from the quatrain aab, the simplest pattern, to the pattern fgfgfgabcde."¹³¹

Of all the poets Ibn Kuzman's work remains in its entirety. His full name was Abu-l-Asbag Isa Bin Kuzman. He was charged with the literary instruction of the Caliph Hisham Al-Muwayad during the time of Al-Mansur. In spite of an early desire to make verse in the classic form, he quickly abandoned the idea and devoted his talents to specialize on the Zajals in Andalusian vulgate, in which he excelled.¹³²

Among the new poets in Al-Andalus there were "two currents," as can be seen in Kuzman's compositions. One style was popular and crude in words and subjects, careless in form and structure; the other erudite, elegant, and beautiful, but pedantic, both in subject-matter and language. Ibn Kuzman attempted to fuse both currents.¹³³

Apart from musical composition, instrument-making achieved a high state

of development in Moorish Spain. Ash-Sphecundi, a resident of Seville in the thirteenth century, reports on the types of musical instruments in that city: The khayal, the carrizo (reed) the lute, the rata, the rabel (rebec), the Kanun (psaltery or harp), the munis, the quenira (type of Zither), the guitar, the Zolami (oboe), the shokra, and the nura (flutes).¹³⁴

The lyric models of the Moors of Andalus was also accepted by the Christian population and it seems reasonable to assume that if the music of the Spanish Moors crossed the Mediterranean Sea and was imitated by people far away, it certainly caught on among the Christians of the Peninsula. When the Moorish cities were reconquered by the Christians they still enjoyed the playing and singing of the Moors. The Christian Kings kept Moorish musicians in their employ even as the Moorish kings before them.¹³⁵

The Andalusian system stayed alive among Spanish poets as late as the middle of the 17th century. Therefore it is also reasonable to assume that the music accompanied the poetry and remained popular for many centuries.¹³⁶

The musical instruments were naturally taken over, beginning with the lute, the noblest and most important of all. Historians confirm that when Arabs introduced the lute to the peninsula, it passed to other European countries where it remained the dominant string instrument until after the Renaissance. The Moors constructed many types of lutes — soprano, baritone, and so forth, and with varying numbers of strings.¹³⁷ (see figure 26)

Among the wind instruments used by Moors of Spain which later became traditional among Christians of the Peninsula are: the Pastoral flute, the Moorish pipes, two kinds of flageolet, and the bagpipes. The instruments of percussion were the bambrel, tambourine, castanets, brass rattles, macara, and atambor.¹³⁸

In the early 1920's, a study was made of two collections of Spanish Christian songs — the *Concionero de Palacio* and the *Cantigas of the Spanish King Alfonso X, The Wise (1252–1284)*.

Within these song books were found a great store of archaic and traditional poetry with the most popular having the same strophic and rhythmic patterns of the Moors.

The *Cantigas*, a repository of music types from southern and northern Spain, includes those preserved among other Spanish-speaking Nations. They include “habaneras and other American melodies and dances and even European music that had been influenced by the music of Spain.”^{139*}

This book of songs was copied in Seville in the 13th century by orders from Alfonso X. Like the *Concionero de Palacio* (another book of songs) it contains “the instrumental and vocal compositions of the Moors who were the professionals at Alfonso’s court.” It is not surprising since Seville had been the Center of Andalusian musical culture and Alfonso X the wise had “many

*Editor’s Note: By this is meant those melodies and dances that were later to turn up among Latin or Hispanic peoples in modern America.

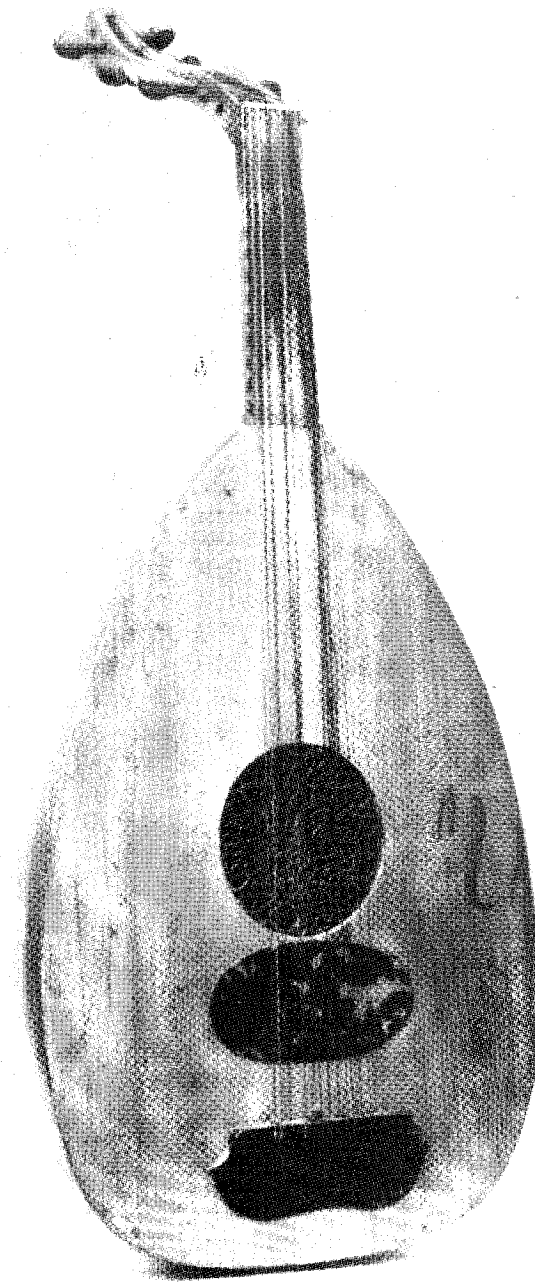

Figure 26. Al-Oud (lute) “The noblest and most important of all.”

Moorish friends" at his court who had translated volumes of literature from Moorish culture.¹⁴⁰

Julian Ribera, whose scholarly study of the lyric poetry of the Spanish Moors was published in the nineteen-twenties, points out that virtually all historians of Western literature "indicate the French and Provençal ancestry of the Cantigas and the Galician poetry of the thirteenth, fourteenth and fifteenth centuries" and thereby deny any influence of the Andalusian Moors. There are more than four hundred songs in the *Cantigas de Santa Maria* of Alfonso X, the Wise. The majority of these fit the pattern of the Andalusian Metric system.

"The truth," says Ribera "is that the greater number of the cantigas are in the Zajal form of the Spanish Moors, created, as we have said, in Andalusia toward the end of the ninth and the beginning of the tenth century. A little strophe, thematic in character, generally a distich, heads each cantiga, and is the refrain to be sung by the chorus. Then comes a strophe of three monorhymed lines, followed by a fourth with a common rhyme for the soloist. Now to recognize this form in the Cantigas, one must keep in mind:

1. That the rhyme is essential to the verse; therefore, where there is no rhyme, one may recognize a cesura and not a full line.
2. That the Cantigas belong to the choral lyric type and not to the monodic.

It is to be remembered in regard to the foregoing observations that the *estribillo* is not to be divided except at rhymes. Only thus may one discover the real form of the Zajals of Alfonso the Wise.

There are only five Cantigas in which Alfonso breaks away from the form of the Spanish Moors to follow the Galician popular tradition, *aab*, *ccb*, in itself a simplification of the *zejel*. Nine of them follow the Provençal pattern. Thus it may be said that ninety per cent of the Cantigas are in the *zajal* pattern."¹⁴¹ All of these cantigas (that is, the ninety percent) showed that they were the instrumental and vocal compositions of the Moors.

The conclusion was made that the Cantigas is a perfect collection of Moorish music, vocal and instrumental, as it was known in the 13th century.¹⁴²

In addition to this, there lies in the Cantigas the key to the interpretation of the manuscripts of the twelfth and thirteenth centuries, especially those of the troubadours. French musicologist, Pierre Aubry, writing on the music of the troubadours noted that they did not preserve "the ecclesiastic tonalities"; and that nowhere in *ars mensurabilis* are there indications that lead to a better understanding of "tonalities employed by the secular musicians." He goes on to say that, other than for a few characteristics, little is recognized as far as tonalities, and even that little is uncertain. Explaining the origin of troubador music, Aubry claims that two musical civilizations co-existed in France. One of these was "the treasure of the ancient Gregorian music with its eight ecclesiastic modes, its free rhythms and its use of Guido's notation." The

other was the music of the century, a worldly production whose origins are unknown to us, in other words *musica ficta*.¹⁴³

In contrast to the ecclesiastic tonalities which have been preserved, the *musica ficta* which appeared during the middle ages featured alterations "by means of accidentals" (sharps and flats) and the introduction of the leading tone. This was unnecessary in Gregorian music. However it was necessary to the very nature of the troubador's music. "These new alterations," says Aubrey "prepared the way for modern tonalities." In regard to the source of the music of the troubadors Salvador-Daniel says it cannot be explained satisfactorily save by admitting the Arab influence in Europe, particularly from the eighth to the fourteenth century. This influence is clear in the case of literature in the South of France, in Spain and in Italy. It must, therefore, have been exerted on music also, which, along with poetry, formed the essence of the troubadours and minstrels.

In our opinion, this is the important aspect of this study, seeing that from it may be deduced curious and interesting information of a period almost unknown in musical history.¹⁴⁴

In his search for the origin of the French "provençal epic poems," Titus Burchardt found no evidence of its origin in early Romance poetry, in fact no trace of any early Romance poetry before the Provençal. The early Provençal epic poems, which precede all Christian-medieval vernacular verse, were quite clearly modelled, he contends, on the Arabic-Andalusian short poem, the *zajal*. This is hardly surprising, since Moorish culture exercised a strong influence on neighboring southern France, and the first known poet of courtly love to write in vulgar Latin, Prince William of Aquitaine, is almost certain to have spoken Arabic. Thus the origins of the Minnesongs, or poems of courtly love, which began in Provence (France) and swept through the German-speaking countries, lay in Moorish Andalusia.¹⁴⁵

A glance at the musical instruments of medieval Spain, as delineated in manuscripts of the tenth and eleventh centuries, and in the "Cantigas de Santa Maria" (thirteenth century) reveals the debt owed to the Moors, while the names of these instruments, preserved in the verses of Juan Ruiz (fourteenth century) fully supplement this assertion. *Laud*, *rabe morisco*, *cano*, *atambor*, *guitarra morisca*, *gayta*, *exabebe*, *albogon*, *anafil*, and *atambal*, were names which came through the Arabic. Other documents tell use of *dulcayna*, *adufe*, *exaquir*, *chirimia* and *xelami*, all of which are derived from the same source.¹⁴⁶ (see figures 27-33)

It is not just the contribution of instruments, although this was major. The songs in the *Concionero* clearly reveal well developed major and minor scales with a regular harmonic bass, *impromptu modulations showing the antiquity of its usage*. Some of the music of the Spanish lute-players of the 15th and 16th centuries were examined. In their music was found a variety of enchanting melodic designs, with chords foreign to the contemporaneous Euro-

pean tradition, with harmonizations as modern as those of a century later.¹⁴⁷ Salvador-Daniel refers to the music of the Moors as “the lost theory of the music of the ancients.” Noting the importance of tracing Moorish civilization he says: “I determined, as far as possible, to follow everywhere the traces of Moorish civilization. In this, no country better than Spain (except Africa, which I had already traversed to a great extent) could offer the traces of what the music of the first centuries of our era was.”¹⁴⁸

Farmer contends that the chief contributions of the Moors to Medieval Europe was mainly on the “instrumental side.” He turns to Carl Engel (*Early History of the Violin Family*, p. 79) who says that when Moors arrived in Europe in the Eighth Century, they were more advanced in the cultivation of music particularly in the construction of musical instruments than the European nations. Further the Moors were the first to introduce a scientific description of musical instruments and possessed the only “didactic instrumental methods in Europe during the Middle Ages.”¹⁴⁹ There are historians who acknowledge the contribution in the matter of musical instruments to “Medieval Europe,” but deny any musical theory coming from the Moors. Regarding this, Farmer says that two points have been overlooked in his argument on what he calls “Arabian Culture contact.” (1) “The political contact which began in the eighth century was spread abroad by the instrumentalists mainly, and (2) the literary and intellectual contact which began in the tenth century was due chiefly to the intellectuals.” Since there was such an “advanced state of instrumental music” it would be difficult to deny that some practical theory would have also been passed along. “Indeed, I believe, with others,” says Farmer “that the major mode, due directly to the accordatura and fretting of the Arabian lute, was among the new musical ideas introduced in this way.” He also points to evidence of the transmission by the Moors of practical theory, of “solfeggio, notation, tablature, organum, consonances, etc.”¹⁵⁰

For years a shroud has hung over the music of Spain, the source of development of both its classical and popular forms being virtually unknown. Historians have claimed ignorance of its “progress” and even suggested that it was, in terms of its origin, set apart from other countries of Europe. One scholar declared that “modern Spanish folk-music had nothing in common with that of the middle ages.” At the same time many Spanish musicologists of today deny a Moorish influence on Spanish music, (although a Moorish Civilization existed in Spain from the Eighth to the Fifteenth Century). Rather they seek for all the roots of, and influences on, Spanish music in modern European music or ancient European culture. They do so in vain. For the history of Moorish music may be fragmented, its contributions, for various reasons, denied or suppressed, but it is neither dead nor buried. It lives on, like a subtle and vital undercurrent, in the modern music of Andalusia, in parts of Africa, and even, like a ghostly refrain, in the *Sketches of Spain* by Miles Davis and the *Ole’* of John Coltraine.

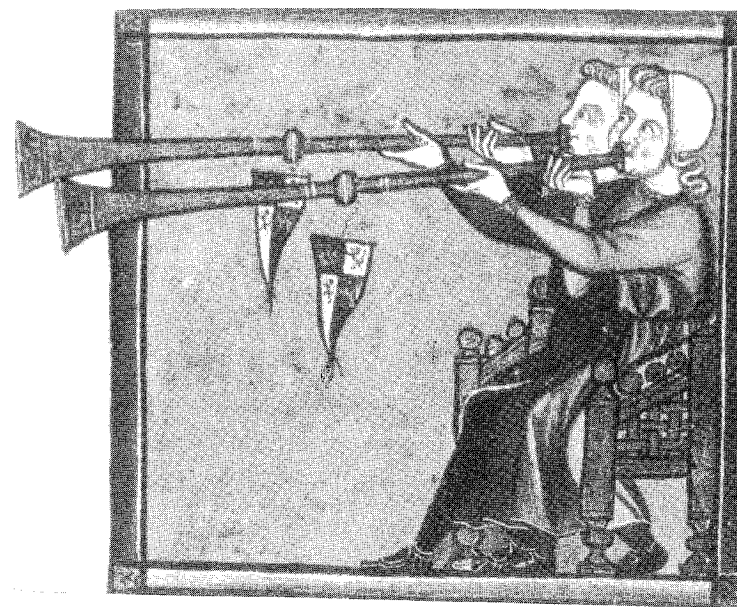

Figures 27 and 28. European musicians playing Moorish musical instruments from the *Cantigas de Santa Maria* of Alfonso X of Castile.

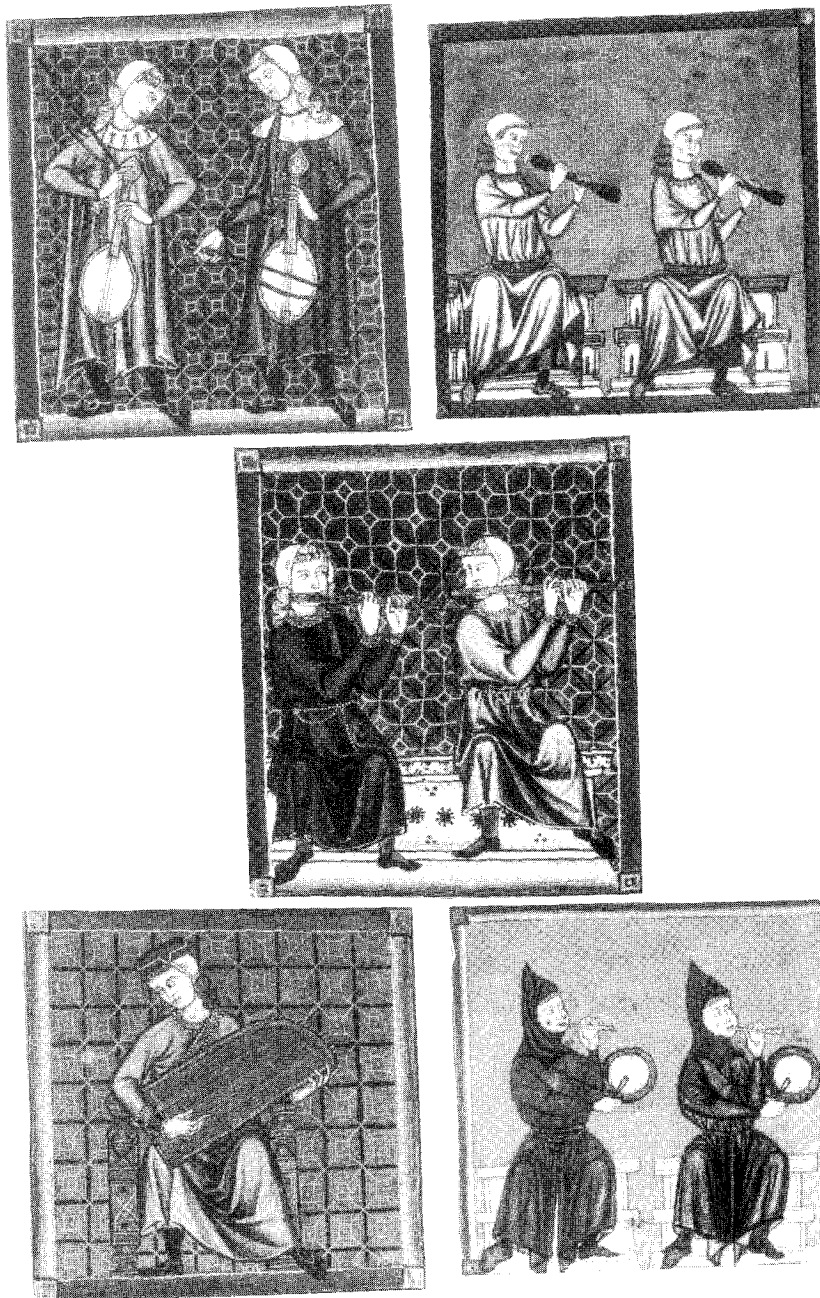

Figures 29, 30, 31, 32, and 33. Moorish instruments displayed by European musicians, from the Cantigas.

COMPARATIVE TABLE OF RHYTHMS

ARAB SONGS

ARS MENSURABILIS

Hezej

Fifth mood of Walter Odington

$\dot{\bar{b}} \check{\bar{y}} \mid \dot{\bar{b}} \check{\bar{y}} \mid \dot{\bar{b}} \check{\bar{y}} \mid$
 $\rho \cdot \mid \rho \cdot \mid \rho \cdot \mid \rho \cdot \mid$

Ramel

Second mood, *idem*

$\dot{\bar{b}} \mid \dot{\bar{b}} \check{\bar{y}} \mid \dot{\bar{b}} \mid \dot{\bar{b}} \check{\bar{y}} \mid \dot{\bar{b}} \mid \dot{\bar{b}} \mid$
 $\rho \rho \mid \rho \rho \mid \rho \rho \mid \rho \rho \mid$

First mood, *idem*

$\rho \rho \mid \rho \rho \mid \rho \rho \mid \rho \rho \mid$

First Takil

$\dot{\bar{b}} \dot{\bar{b}} \mid \dot{\bar{b}} \check{\bar{y}} \mid \dot{\bar{b}} \dot{\bar{b}} \mid \dot{\bar{b}} \check{\bar{y}} \mid \dot{\bar{b}} \dot{\bar{b}} \mid \dot{\bar{b}} \mid$

Second Takil

Third mood, *idem*

$\dot{\bar{b}} \dot{\bar{b}} \mid \dot{\bar{b}} \check{\bar{y}} \mid \dot{\bar{b}} \dot{\bar{b}} \mid \dot{\bar{b}} \check{\bar{y}} \mid \dot{\bar{b}} \dot{\bar{b}} \mid \dot{\bar{b}} \mid$
 $\rho \cdot \rho \rho \mid \rho \cdot \rho \rho \mid \rho \cdot \rho \rho \mid$

Fourth mood, *idem*

$\rho \rho \rho \cdot \mid \rho \rho \rho \cdot \mid \rho \rho \rho \cdot \mid$

Makhuri

$\dot{\bar{b}} \dot{\bar{b}} \dot{\bar{b}} \mid \dot{\bar{b}} \check{\bar{y}} \mid \dot{\bar{b}} \dot{\bar{b}} \dot{\bar{b}} \mid \dot{\bar{b}} \check{\bar{y}} \mid \dot{\bar{b}} \dot{\bar{b}} \dot{\bar{b}} \mid \dot{\bar{b}} \mid$

Sixth mood

$\rho \rho \rho \mid \rho \rho \rho \mid \rho \rho \rho \mid \rho \rho \rho \mid$

Figure 34. Moorish rhythmic modes and the rhythms of the Ars Mensurabilis (Ribera, p. 195).

35^a



9^a



Figure 35. Hezej.
 Figure 36. Ramel.
 Songs from the Cantigas. Showing Hezel and Ramel rhythmic modes.

30^a



42^a



Figure 37. 1st Takil
 Figure 38. 2nd Takil.
 Cantigas of Alphonso the Wise. Showing first and second Takil rhythmic modes.

Notes

13.^a

Figure 39. Mukhuri.

A Cantiga of Alphonso the Wise showing a Mukhuri rhythmic mode.

1. John M. Chernoff, *African Rhythm and African Sensibility-Aesthetics and Social Action in African Musical Idioms* (University of Chicago, and London), 1979, p. 27.
2. Okon Edet UYA, *Global dimensions of the African Diaspora*, (Howard University Press, Wash. D.C.), 1982 (Joseph E. Harris, Editors), p. 73.
3. Chernoff, p. 33.
4. Paul Bohannon, *Hangups from Wayback: Historical Myths and Canons Vol. II*, (Canfield Press, San Francisco) 1970, Fredrick Gentles and Melvin Steinfield, Editors), p. 232.
5. Ashenafi Kebede, *Roots of Black Music – The Vocal, Instrumental, and Dance Heritage of Africa and Black America*, (Prentice Hall, Inc., Englewood Cliffs, N.J.), 1982, p. 62.
6. Alan P. Merriam, *The Anthropology of Music* (Northwestern University Press), 1964, p. 287.
7. Kebede, p. 70.
8. Ibid, p. 10.
9. Ibid, p. 10.
10. Ibid, p. 10.
11. Ibid, p. 10.
12. William P. Malm, *Music Cultures of the Pacific, The Near East and Asia*, 2nd Edition, Prentice Hall Inc., Englewood Cliffs, N.J.) 1977, p. 82, 83.
13. Merriam, p. 281, 282.
14. Miles Davis, *The Autobiography*, with Quincy Troupe, (Simon and Schuster, N.Y., London) 1989, p. 241.
15. Ibid, p. 242.
16. Stanley, Lane Poole, *The Story of the Moors in Spain* (G. P. Putnam's, N.Y. and London), 1886, p. 43.
17. Henry George Farmer, *Historical Facts for the Arabian Musical Influence*, 1970 (George Olms Verlag, Hildesheim, New York) p. 21.
18. J. A. Rogers, *Sex and Race Vol. I*, (Helga M. Rogers, St. Petersburg, Fl.), 1967, p. 95.
19. John Hunwick, *The Muslim Journal*, Vol. 16, No. 11, 1991 (Muslim Journal Inc., Chicago, Illinois) p. 1, 21.
20. J. A. Rogers, p. 96.
21. Ibid, p. 102.
22. Farmer, p. 2, 3.
23. Malm, p. 52.
24. Ibid, p. 54.
25. Ibid, p. 54.
26. Ibid, p. 54.
27. Ibid, p. 11.
28. Ibid, p. 11.
29. Ibid, p. 11.
30. Ibid, p. 12.
31. Ibid, p. 14.
32. Ibid, p. 13.
33. Ibid, p. 13.
34. Ibid, p. 55.
35. Ibid, p. 55.

36. Ibid, p. 55.
37. Johannes N. Colaisen, *Ecology and Culture of the Pastoral Tuareq*, (National Museum of Copenhagen), 1963, p. 438.
38. Ibid, p. 439.
39. Anwar Chejne, *Muslim Spain: Its History and Culture* (University of Minnesota Press), 1974, p. 234.
40. Ibid, p. 233.
41. Ibid, p. 236.
42. Ibid, p. 246.
43. Ribera, p. 86.
44. Kebede, p. 15.
45. Malm, p. 55.
46. Kebede, p. 16.
47. Ibid, p. 17.
48. Ibid, p. 17.
49. Ibid, p. 17.
50. Farmer, p. 50.
51. Ibid, p. 50, 51.
52. Ibid, p. 117.
53. John A. Williams in *African Presence in Early Europe*, Editor Ivan Van Sertima (Transaction Publishers, N.J.) 1988, p. 83.
54. Farmer, p. 51.
55. Ibid, p. 52.
56. Ibid, p. 56.
57. Ribera, p. 31.
58. Ibid, p. 32.
59. Farmer, p. 53.
60. Ibid, p. 57.
61. Ibid, p. 54.
62. Ribera, p. 30.
63. Ibid, p. 30.
64. Farmer, p. 63.
65. Ibid, p. 64.
66. Ibid, p. 64.
67. Ibid, p. 64, 65.
68. Ribera, p. 32.
69. Chejne, p. 369.
70. Ibid, p. 369.
71. Ibid, p. 370.
72. Ibid, p. 370.
73. Ibid, p. 34.
74. Ibid, p. 36.
75. Ibid, p. 37.
76. Ibid, p. 42.
77. Chandler.
78. Ali Baghdadi, *Bilalian News*, (Muhammad's Mosque #2, Chicago, Ill.), 1976, Vol. 1, No. 27.
79. Ribera, p. 48.
80. Ibid, p. 48.
81. Ibid, p. 50.
82. Ibid, p. 50.

83. Ibid, p. 49.
84. Ibid, p. 49.
85. Ibid, p. 50.
86. Ibid, p. 51.
87. Ibid, p. 51.
88. Farmer, p. 247.
89. Ibid, p. 248.
90. Ibid, p. 248.
91. Ibid, p. 248.
92. Ibid, p. 248, 249.
93. Ribera, p. 51, 52.
94. Ibid, p. 77.
95. Emil Naumann — *History of Music* (Cassell and Co., London, Paris), Vol. 1, p. 89, 90.
96. Ribera, p. 76.
97. Ibid, p. 76.
98. Ibid, p. 77.
99. Chejne, p. 370.
100. Ribera, p. 98.
101. Ibid, p. 99.
102. Ibid, p. 99.
103. Ibid, p. 100.
104. *Ahmed Ibn Mohammed Al-Makkari*, Translator Pascual De Guyangos (Johnson Reprint Corp., New York, N.Y.), 1964, Vol. 1 book 2, p. 410.
105. Ibid, p. 410.
106. Ibid, p. 411, 412.
107. Ribera, p. 116.
108. Chejne, p. 372.
109. Al-Makkari, p. 121.
110. Ibid, p. 119, 120.
111. Ibid, p. 119.
112. Ibid, p. 119.
113. Titus Burckhardt, *Moorish Culture in Spain* (McGraw Hill, N.Y., Toronto), 1972, p. 71.
114. Jan Reade, *The Moors in Spain and Portugal* (Faber and Faber, London), 1974, p. 65.
115. Makkari, p. 120.
116. Ibid, p. 120.
117. Ibid, p. 120.
118. Ibid, p. 120.
119. Ibid, p. 120, 121.
120. Read, p. 57.
121. Ibid, p. 65.
122. Ribera, p. 105.
123. Ibid, p. 106.
124. Ibid, p. 117.
125. Ibid, p. 117.
126. Ibid, p. 118.
127. Ibid, p. 119.
128. Ibid, p. 119.
129. Ibid, p. 125.

130. Ibid, p. 125.
 131. Ribera, p. 128.
 132. Ibid, p. 131.
 133. Ibid, p. 131.
 134. Ibid, p. 138.
 135. Ibid, p. 143.
 136. Ibid, p. 154.
 137. Ibid, p. 154.
 138. Ibid, p. 155.
 139. Ibid, p. 7.
 140. Ibid, p. 5.
 141. Ibid, p. 190, 191.
 142. Ibid, p. 5, 6.
 143. Ibid, p. 182.
 144. Francesco Salvador-Daniel, *The Music and Musical Instruments of the Arab*, Editor, Henry George Farmer (Longwood Press, Portland, Maine) 1915, p. 108.
 145. Burchardt, p. 87.
 146. Farmer, p. 13.
 147. Ribera, p. 175.
 148. Daniel, p. 53.
 149. Farmer, p. 61
 150. Ibid, p. 62.

THE MOORS AND PORTUGAL'S GLOBAL EXPANSION

EDWARD SCOBIE

For all the negroes or black Moors are descendants of Cush, the son of Ham, who was the son of Noah. But whatever difference there is between the negroes and the tawny Moors, it is a fact that they are all of the same ancestry.

*Leo Africanus, A Geographical
 Historie of Africa, 1600*

That ancestry to which Leo Africanus was referring is African. European scholars in the past five hundred years have been deliberately dishonest in their writings about Africa. There are innumerable instances, much too numerous to catalogue in this work, of this dishonesty. However, we cannot ignore the fact that certain western scholars have claimed that the Moors belonged to every other race except African. As a result much confusion has been spread around the word "Moor."

This study is not intended to prolong the discussion about who the Moors were or who they were not. Scholars who are not blinded by the fog of racism are of one voice that most of the Moors were Africoid in origin; even many of the marauding Arabs who crossed the desert sands of Arabia and swept down with their Islamic fervor on northern regions of Africa, then crossing the Sahara and moving further southward. Massive miscegenation did alter the picture, producing people who were of all shades, from jet black to very near "white." Dr. Chancellor Williams hits the nail on the head, once and for all, when he asks and answers the question:

Now, again, just who were the Moors? The answer is very easy. The original Moors, like the original Egyptians, were Black Africans. As amalgamation became more and more widespread, only the Berbers, Arabs and coloureds in the Moroccan territories were called Moors, while the darkest and black skinned Africans were called "Black-a-Moors." Eventually, "black" was dropped from "Blackamoor." In North Africa—and Morocco in particular—all Muslim Arabs, mixed breeds and Berbers are readily regarded as Moors. The African Blacks, having had even this name taken from them, must contend for recognition as Moors.

Dr. J.C. DeGraft-Johnson, in his study, *African Glory (The Story of Vanished Negro Civilizations)* states categorically that:

It was because the conquering army in Spain was largely made up of Africans from Morocco that we hear such phrases as "the Moorish



Aldridge as Othello

invasion of Spain," and why Shakespeare's hero Othello is a Moor, and why the word "blackamoor" exists in the English language, a word which leaves no doubt as to the colour of the army of occupation in Spain and Portugal.

The term "Arabic" contends Dr. DeGraft-Johnson, must be understood in a cultural rather than a racial sense, "for the Arabs did not believe in any herrenvolk theory and freely intermarried with those they conquered." Their conquest of North Africa, however, was no walk-over except perhaps in Egypt, where the Arabs were looked upon as deliverers from the oppressive rule of Byzantium. The fierce resistance mounted by Kuseila of Mauritania and by his relative Kahina projected the African mood at that period. In fact, so fierce and determined were the African counter-attacks that an Arab governor once saw fit to observe that the conquest of Africa was impossible. Scarcely had a Berber tribe been exterminated when another would take its place. Nevertheless, upon conquest, Africans appear to have been converted to the Mohammedan faith particularly through the system of intermarriage which was practised on an extensive scale by the Arabs. Among the African leaders converted to the Islamic faith during the invasion of Morocco was the great general known as Tarik. In describing Tarik and his army who captured Spain, chroniclers of the time made note that these Moors were "a black or dark people, some being very black."

The conquest of Spain has been described by Dr. DeGraft-Johnson as an African conquest. Like other historians before and after him he made it clear that the conquerors were Mohammedan Africans, not Arabs, "who had laid low the Gothic Kingdom of Spain." The Arab quotient of this conquest was added by Professor C.P. Groves in his book, *The Planting of Christianity in Africa (1948)*, when he stated that the Arab leader Musa-ibn-Nusair "apparently taken by surprise at the speed of events, hastened across with an army the following year and completed the conquest, thus associating Arab arms with the final victory."

This statement that the Arab leader Musa-ibn-Nusair had been taken by surprise by Tarik's invasion of Spain the previous year (711 A.D.) needs some clarification. It was Musa-ibn-Nusair who, after having invaded Morocco gave Tarik the rank of general and left him in charge of Tangiers, making him governor of Mauritania. So when the African general decided that he intended crossing the straits to survey and examine the possibilities for an invasion he accordingly informed Musa-ibn-Nusair of his intentions. He carried out these intentions under his own leadership without the presence of Musa-ibn-Nusair. In 711, accompanied by 100 horses and 400 soldiers, General Tarik crossed over into Spain on this exploratory mission. He made landfall near the Spanish town of Algeciras and finding the country with virtually little or no defense, he ravaged the neighboring towns with his small army, returning to Africa laden with spoils. It was at this stage that Tarik gave an account of his



Figure 1. Alessandro dei Medici, Duke of Florence, son-in-law of the Emperor Charles V. His father was a pope (Clement VII) and his mother, Anna, an African woman (See Figure 2). Alessandro was always referred to as Alessandro, the Moor.

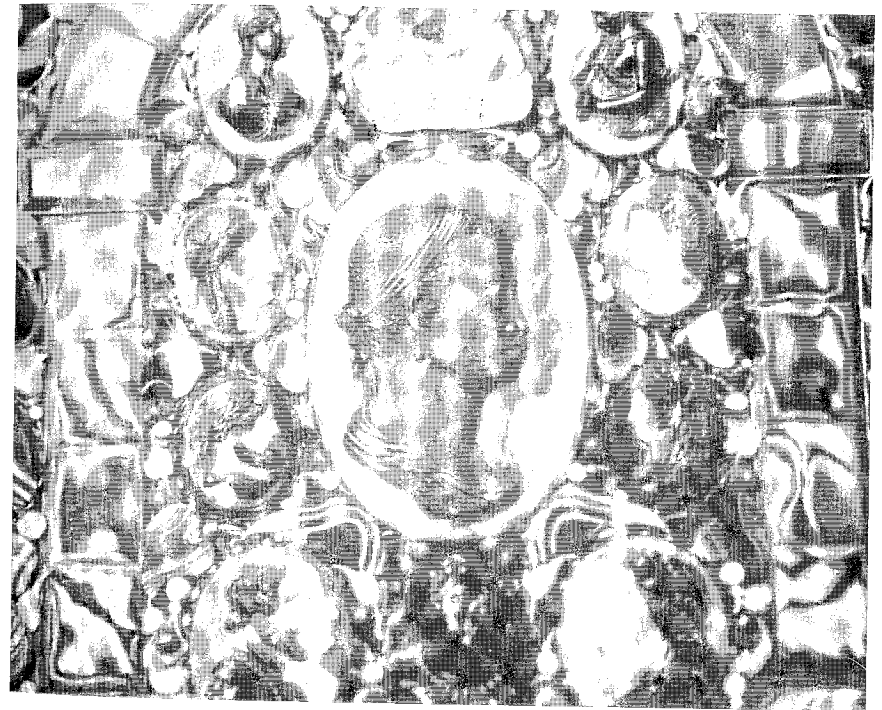

Figure 2. Anna, an African woman, mother of Alessandro dei Medici, the first Duke of Florence.

mission to Musa-ibn-Nusair and later that same year he set sail again for Spain, this time in command of an army of 7,000 Africans.

The story of this second invasion of the Iberian peninsula by African and Arab warriors is legendary. DeGraft-Johnson called it "an African conquest." Basil Davidson, who has been recognised as the most distinguished of historians, declared that there were no lands at that time (the eighth century) "more admired by its neighbors, or more comfortable to live in, than a rich African kingdom which took shape in Spain." It is good to observe here that Basil Davidson did not resort to the words "Arab kingdom," but that does not mean that Arab arms did not take part in the final victory. It was this Moorish invasion under the leadership of the African General Tarik which spurred the first great wave of miscegenation. In less than three years the Moors had conquered the entire Iberian Peninsula. The color of the conquering soldiers was described vividly by a European scholar who sympathized with Christian Spain:

the reins of their (Moors) horses were as fire, their faces black as pitch, their eyes shone like burning candles, their horses were swift as leopards and the riders fiercer than a wolf in the sheepfold at night ... The noble Goths were broken in an hour, quicker than tongue can tell. Oh, luckless Spain!

Other writers were not of the opinion that the conquest of Spain and Portugal was a disaster. The whites in those Iberian countries were not viewed in a favourable light:

They are nearer animals than men ... They are by nature unthinking and their manners crude. Their bellies protrude; their color is white and their hair is long. In sharpness and delicacy of spirit and in intellectual perspicacity they are nil. Ignorance, lack of reasoning power and boorishness are common among them.

The Moors had a particularly low opinion of these whites. They had beaten them often on the battlefield and with inferior numbers. Even the Europeans in other countries of this continent were looked upon with disdain for their low intelligence and base ways of life. Modern European historians agree with Moorish writer Michaud in his *History of the Crusades* when he describes the Prussians of the thirteenth century as being just a few stages above savagery. The palaces of the then rulers of Germany, France and England were, when compared with those of the Moorish Rulers of Spain and Portugal, "scarcely better than the stables" of the Moors. The education of the Moors was at such a high level that their scholars of Toledo, Cordova and Seville were producing treatises on spherical trigonometry when the mathematical syllabus of the University of Oxford stopped abruptly at the fifth proposition of the book of Euclid. It was this superior intellect of the Moors

which caused Stanley Lane-Poole in his famous *The Story of the Moors in Spain* to note: "Whatever makes a kingdom great, whatever tends to refinement and civilization was found in Moorish Spain."

The same degree of intellect and learning was brought by the Moorish conquerors of the Iberian peninsula to Portugal. Like Spain, that country was to be culturally influenced by the Moors. Its association with Africa dates as far back as the fourth and fifth centuries when Africans arrived in southern Europe. But it was in 711 A.D. that they marched in as conquerors under the command of Tarik. To reinforce what has been said earlier these Moors, as the early writers chronicled, were "a black or dark people, some being very black."

After the invasion of 711 came other waves of Moors even darker. It was this occupation of Portugal which accounts for the fact that even noble families had absorbed the blood of the Moor.

From that time onwards, racial mixing in Portugal, as in Spain, and elsewhere in Europe which came under the influence of Moors, took place on a large scale. That is why historians claim that "Portugal is in reality a Negroid land," and that when Napoleon explained that "Africa begins at the Pyrenees," he meant every word that he uttered. Even the world-famed shrine in Portugal, Fatima, where Catholic pilgrims from all over the world go in search of miracle cures for their afflictions, owes its origin to the Moors. The story goes that a Portuguese nobleman was so saddened by the death of his wife, a young Moorish beauty whom he had married after her conversion to the Christian faith, that he gave up his title and fortune and entered a monastery. His wife was buried on a high plateau called Sierra de Aire. It is from there that the name of Fatima is derived.

The Moors ruled and occupied Lisbon and the rest of the country until well into the twelfth century. They were finally defeated and driven out by the forces of King Alfonso Henriques, who was aided by English and Flemish crusaders. The scene of this battle was the Castelo de Sao Jorge or, in English, the Castle of St. George. Today, it still stands, overlooking the city of "Lashbuna" — as the Moors named Lisbon.

The defeat of the Moors did not put an end to their influence on Portugal. The African (Moorish) presence can be seen everywhere in Portugal; in the architecture of many of the buildings. They still retain their Moorish design — like the Praca De Toiros — the Bull Ring in Lisbon. A walk through Alfama — the oldest quarter in Lisbon, with its fifteenth century houses, narrow-winding streets — dates back to the time when it was the last settlement of the Moors. Fado singers abound in all corners and bistros of Alfama. Their songs and rhythms owe much to the influence of the Moorish musicians centuries ago. Even the fishing boats on the beaches of Cascais show marked African traces.

Called the rabelos, these boats with their large red or white sails which also ply on the Douro River to fetch wine from the upper valleys, are reminiscent of the transport boats of Lagos in Nigeria.

A deeper examination of Portugal within the time-frame of the Moorish invasion and occupation reveals a constant intermingling of White and Moor. Historians claimed that the mingling of the races in Portugal, as with Spain, "had much to do with the later high civilization reached by the Moors." The African element was more predominant in Portugal than it was in Spain, some historians contend. The noble families in Portugal and in Spain, too, who had absorbed the blood of the Moor were innumerable. Even some of the knights who, in the wars of conquest distinguished themselves, had such blood. Of the Count of Coimbra, Don Sesnado, the chronicles tell us that he was of mixed blood, of Christian and Moor, and that he was a vizier among the Saracens. Another of mixed blood, Dom Fifes Serrasim, became a member of the Christian nobility by marrying a Mendes de Braganza.

Many European historians who constantly project biased scholarship in their writings of Africa and Africans, persist in denying the tremendous influence, both culturally and genetically, that the Moors (Africans) had on the countries of the Iberian Peninsula, particularly Portugal and Spain. One scholar, Gandia, stated bluntly:

As to the mixture of Moors and the other inhabitants of the Iberian Peninsula it is useless to deny its occurrence. Without going into the social life of the Christians and Moslems, it may be mentioned in passing that the son of Musa married the widow of King Roderick and that the royal family of Witza united with the Moors of the purest stock.

In order to get a clearer picture of what this marriage of the son of Musa signified in terms of unifying "with the Moors of the purest stock," it is necessary to trace the lineage of "the son of Musa" and Musa himself. To give his full name, Musa-ibn-Nusair was the African-Arab Governor of Morocco whom Count Julian, the Governor of Ceuta on the northern tip of Morocco, contacted in 709 A.D. and encouraged to invade Spain. In June 712 Musa-Ibn-Nusair crossed the straits with 18,000 troops, mostly Berbers, to support Tariq against a possible strike-back by King Roderick. Musa captured Carmona, Medina, Sidonia and Ceremona, while his son, Abd-al-Aziz, took Seville, Niebla and Beja. After this conquest of Spain, Musa put his three sons in charge of the armies in Spain and North Africa: Abd-al-Aziz in Spain; the other two in Morocco, Algeria and Tunisia.

Although marriage and mixture took place on an extensive scale in Spain and Portugal between White and Moor, the union of Egilona, widow of King Roderick, and Abd-al-Aziz eventually led to the assassination of the latter in 716 as a result of the bitter resentment that the marriage caused among Muslims. Aziz was succeeded as commander of the army in Spain by his



Figure 3. A Black Norman knight and his fair lady (1504–1534). There is evidence of a Moorish presence in Scotland and England as early as the tenth century (see *Ancient Britons* by David MacRitchie).

cousin, Ayyub ibn-Habib, who was eventually replaced by al-Hurr ibn Abdurrahman. At this stage of succession, Muslim rulers were instrumental in extending their rule from Spain and Portugal to many areas in France. In 717 and 719 Hurr crossed the treacherous passes of the Pyrenees and entered France. Unrest in Spain prevented him from gaining any strong foothold in France. It was not until 729 that another Moorish ruler Haytham-ibn-Ubayd was successful in capturing Lyon, Macon and Chalons-sur-Saone in France. Beaune and Autun were also under the control of the Berbers; and it was a Berber leader named Uthman-ibn-Abi-Nisah, known sometimes as Munuza, who governed not only Spain but parts of France as well. Munuza established excellent relationships with the Christians of France, Spain and Portugal, and married the daughter of Duke Eudes, Lampegie of Aquitaine.

This period of Moorish rule between 719 and 729 was rife with intrigue and treachery. When al-Hurr-ibn-Abdurrahman was replaced by ab-Samh-ibn-Malik, the latter transferred the Spanish capital from Seville to Cordoba. He completely reorganized the finances of the country and system of taxation, carrying out several public works, and putting into operation an extensive survey of the land. He died in May 721 and was replaced by Abdurrahman-ibn-Abdullah who was quickly deposed in favor of Yahya-ibn-Salmah. In rapid succession two other Muslim rulers took control but were finally ousted; and once again, Abdurrahman-ibn-Abdullah gained office.

Abdullah proved to be a strong ruler. Under his leadership the rival factions in the Empire became reconciled. But he was challenged by Munuza. Because of that challenge Abdullah set about the destruction of Munuza who had entered into intrigue with his father-in-law, Duke Eudes. Abdullah finally succeeded in killing Abu-Nisah, known also as Munuza, and sending the latter's wife to Damascus, where she married the son of the Caliph, Hisham.

Abdullah then crossed the Pyrenees and delivered a crushing blow against Duke Eudes on the Garonne, sacked Bordeaux and went across Politiers into Tours. It was at this point in 732 that Abdullah went into battle with Charles Martel. He died in that fight and Tours marked the western limit of the Umayyad Empire. It is universally agreed that the Berbers, with their black blood, mixed with some Arab, became a conquering people. They would have taken the whole of France had they not clashed with Charles Martel in Tours. However, they remained in Southern France until 1140, principally in the Camarque on the western Riviera, which is still known as La Petite Afrique.

In the centuries that were to follow, these same African (Moorish) conquerors civilized backward Spain and Portugal. The court of the Moorish rulers at Cordoba became the center of culture. Art, learning, refinement and elegance marked the reign of these African conquerors. Commerce flourished, mathematics, science and medicine found their way through the cultural darkness of Spain. This same cultural enlightenment was taken to Portugal by the conquering Moors of Africa. Contact with the Far East brought Spain and

Portugal a real renaissance when other parts of Europe were spending a thousand years passing through the dark age which the destruction of Rome by the barbarians had brought about.

Moorish domination extended to parts of Italy. In 846 A.D., they held the city of Rome in a state of siege while in 878 they captured Sicily from the Normans. Twenty years later the Moors took control of Southern Italy by defeating Otto II of Germany. As in Spain and Portugal, miscegenation took place on a wide scale between the Moors and the Italians who at that time had large infusions of Germanic blood due to the invasion of the Goths and Vandals. Like Portugal and Spain the blood of Africa permeated through all layers of Italian society and found its way into the leading families, including the most illustrious royal family of the times—the Medicis. Color was no bar to power and honor in Italy. This was illustrated when Alessandro dei Medici, known as “The Moor,” became the first Duke of Florence.

The Moors also dominated the British Isles at one point in history. The British archeologist and writer David McRitchie declared that the Moors dominated Scotland as late as the time of the Saxon Kings. He stated with scholarly authority:

So late as the tenth century three of these provinces [of Scotland] were wholly black and the supreme ruler of these became for a time the paramount king of transmarine Scotland. We see one of the black people—the Moors of the Romans—in the person of a King of Alban of the tenth century. History knows him as Kenneth, sometimes as Dubh and as Niger.... We know as a historic fact that a Niger Val Dubh has lived and reigned over certain black divisions of our islands—and probably white divisions also—and that a race known as the “Sons of the Black” succeeded him in history.

It is no exaggeration, then, to claim that the Moors were a leading power in those six or seven centuries from the time of Tarik's conquest on the Iberian Peninsula. They dominated the Mediterranean and the North Atlantic and held power over the coasts of Western Europe and the British Isles, as has been stated earlier. But it is not for their military conquests in Europe that the Moors are remembered. It is the culture and learning which they gave to European countries at a time when there was darkness and nothing elevating in the arts and sciences of a country that was to claim falsely in later centuries to be the cradle of the civilization of the world. That this civilization was first given to them by the Africans who remained in European countries for several centuries has stayed shrouded in perjuries, half-truths, mythologies and/or total omissions. This civilization, brought by the African Moors, needs further and deeper examination, especially as Spain and Portugal were the first countries in Europe to benefit from the enlightenment which the African warrior-scholars carried with them from across the African mainland through the Mediterranean Sea to Iberia, and to other European countries further

inland. In Britain, for instance, the Morris-dance, England's national dance which has been performed every May-day for centuries was originally a dance performed by Moors. It is of African origin, and was introduced in England before William the Conqueror in 1066. Sir John Hawkins, an eighteenth century man-of-letters and music authority in London, wrote: "It is indisputable that this dance was the invention of the Moor." Tabourot, another authority, chronicled the same strong statement. Dr. Samuel Johnson who compiled the first English dictionary in the middle years of the eighteenth century defined the Morris dance as "A Moorish dance" and the invention of the Moors in England in the seventeenth century. Any kind of entertainment or masquerade was called "Mauresque," wrote Paul Mettl, "because the guise of the black man was the most important and popular, a phenomenon which points on the one hand to the significance of the black race for the aesthetic life of the whites; on the other hand to the ancient habit of all Europeans to paint the face black on certain occasions of cult ritualism." Nettle quotes Arbeau, the French writer of the sixteenth century, who stated that often in good society he would see "a youth with blackened face" do this Morris dance. In the Italian madrigal literature of the Renaissance, says Arbeau, "real Negroes were introduced." Real African minstrels were popular entertainers in the Scottish and Tudor courts of England during the fifteenth century. David McRitchie writes:

In 1501 one of the King's minstrels was Peter the Moryen or Moor ... In 1504 two blackamoor girls arrived and were educated at the court where they waited on the Queen. They were baptized, Elen and Margaret. In June 1507 a tournament was held in honor of the Queen's black lady, Elen Moore, which was conducted with great splendor.

Queen Elizabeth I had one favorite African in her Tudor court. She was Luce Morgan also known as Lucy Negro. Elizabethan history tells much about this fascinating African beauty who was sought after by gentlemen in the Inns of Court in London, titled men and even William Shakespeare. Her association with the Bard of Avon was not only intriguing but mysterious as well. That love affair has been meticulously swept under the carpets of English history. But eventually the truth will always show itself and this one is now known to an ever-growing number of scholars. The effect that Luce Morgan had on Elizabethan England was tremendous. She made her entry into some entertainments that were being given at the Inns of Court in grand style. The occasion has been described in this manner by a historian:

The Gray's Inn Revels were different that Christmas of 1594. But the idea was still the same: entertainments to parody the affairs and ceremonies of the English court. The Revels would start on Hallowe'en and last until Candlemass. A Prince of Purpool was installed on December 20th.

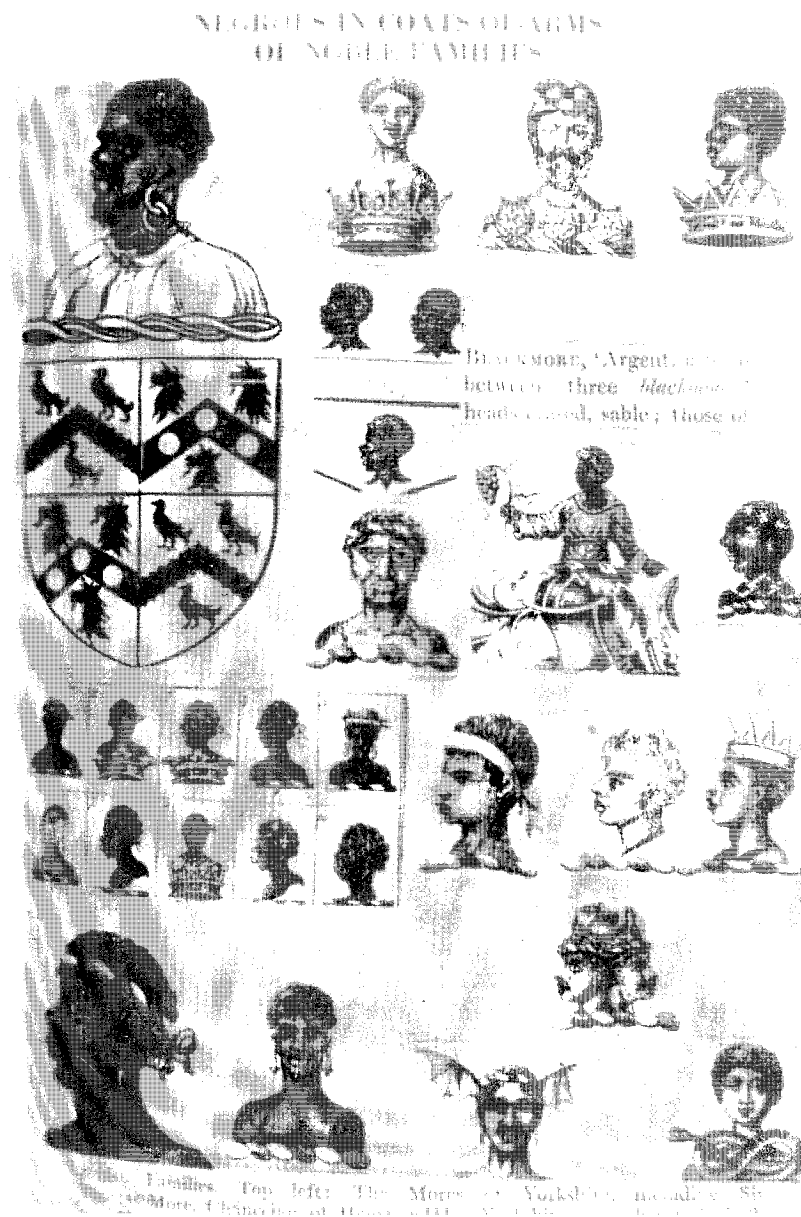

Figure 4. Moors on coats-of-arms of medieval English families.

He was two characters in one — Purpool and the Lord of Misrule. By the 28th there were so many spectators that Gray's Inn Hall became too packed for anyone to enter. That evening the actors put on the Comedy of Errors. Six days later the Revels were in full swing. Among those present were Lord Burleigh, the Earl of Essex, the Lord Keeper, Sir Robert Cecil and the Earls of Shrewsbury, Cumberland, Northumberland, and Southampton. The amusements began with a symbolic piece of the restoration of amity between Graius and Templarius. After that the Prince of Purpool held court. To pay homage to him came the Abbess of Clerkenwell, "with a choir of Nuns, with burning lamps, to chaunt Placebo to the gentlemen of the Prince's Privy-Chamber, on the Day of His Excellency's Coronation."

It was the Abbess who made the difference in that year's Revels. For she was not a lady of court but a courtesan from Clerkenwell. She was tall, statuesque, and haughty. Her name was Lucy Negro and she was in fact black and an African.

Dr. George Bagshawe Harrison, an authority on Shakespeare, claims that Shakespeare fell in love with Lucy Negro only to lose her later to the Earl of Southampton. Dr. Harrison makes a further more startling statement: "This Lucy Negro I would identify as the Dark Lady of the Sonnets"; the woman to whom William Shakespeare is said to have written these immortal lines.

Dr. Leslie Hotson, a man of brilliant and unorthodox scholarship and an expert on Shakespeare, after exhaustive research throws further light on Lucy Negro:

I have been at some pains to collect facts and reports about Luce Morgan. My reward is the discovery of a series of documents indicating that some years before she charmed Shakespeare she had first charmed Queen Elizabeth.

In the England of the Tudor monarchs in the fifteenth century and after blacks were very much in evidence in a particular show, London's colorful Lord Mayor's show. One black known as "King of the Moors," mounted on a "lion" and preceded by other Africans bearing bars of gold, would lead the show. In 1680 a historian wrote: "On the Lion is mounted a young African Prince attired in a very right habit ... with a gold hilt in scarf of gold by his side. With one hand he holds a golden Bridle, in the other St. George's Banner and representh power." Such were the scenes in various cities during the twilight of the power of the Moors in Europe. Another kind of African was making entry into Europe, this time not as conqueror, but as captive. But that is another story with tragic dimensions. Let us go back to the conquering but scholarly African Moors who peopled the Iberian Peninsula and other areas of that backward continent of Europe. They were the first to bring the benefits of civilization and scholarship to a continent sunk in the very abyss of vulgarity and barbarism.

David McRitchie produces enough evidence to prove that a race of Africans (Moors) lived in Scotland and parts of England well back into the tenth century. He writes: "Our language still retains the memory of their presence," and goes on to say that:

In Shakespeare's time the audience at the Globe accepted the word as meaning 'a black man', and either then, or later on, it became tautologically extended into 'blackamoor'. The common people of the country are not likely to have known much about the ultra-British 'Moors', — not enough at any rate, to have made the word an everyday term for a black man. Nor can the Moors of heraldry be explained sufficiently by the theory that the founders of families bearing Moors as supporters, and Moors' heads as crests, had won their spurs in assisting the Spaniards expel their Moors. The bearing is too common among ancient coats-of-arms to admit of this explanation. And the heraldic representation of a "Moor" does not suggest Granada.

McRitchie gives the names of many of these families (Moorish) whose names are quite celebrated in English history. One of these is the aristocratic Douglas family, said to be one of the ancestors of the present royal family of Britain. A British authority, J.A. Ringrose, explains about the founder of this family:

About the year 770 in the reign of Salvathius, King of the Scots, Donald Bane of the Western Isles having invaded Scotland and routed the royal army, a man of rank and figure came seasonably with his followers to the King's assistance. He renewed the battle and obtained a complete victory over the invader. The king being anxious to see the man who had done him such signal service, he was pointed out to him by his colour, or complexion in Gaelic language — sholto-du-glash — "behold the black or swarthy coloured man" from which he obtained the name Sholto the Douglas.

McRitchie further states that the most revealing evidence of the Moorish origin of these noble families are "the thick-lipped Moors" on their coat-of-arms. Many of these families still carry the name Moore. Barry's Encyclopaedia Heraldica notes on its pages that "Moor's head is the heraldic term for the head of a black or negro man." McRitchie contends that the racial origin of these notable families stems from the fact that there were black peoples (Moors or Silures) domiciled in Scotland as early as the ninth and tenth centuries. Added to that, some of the bearers of the insignia of the Moor's heads are named Moore. Among the latter are the Rt. Hon. William Ponsonby Moore, Earl of Drogheda; Moore of Hancot; Moore of Moore Lodge; the Earl of Annesly; and Morrison-Bell of Otterburn. Then, according to "Burke's Peerage," the bible of British aristocracy, the coat-of-arms of the Marquess of Londonderry consists of "a Moor wreathed about the temples, arg. and az.,

holding in his hand a shield of the last, garnished or charged with the sun in splendor, gold." Bearers of similar coats-of-arms are the Earl of Newburgh; Viscount Valentia, whose family is related to Annesly and whose arms bear a Moorish prince in armour; and, Baron Whitburgh.

McRitchie maintains that these noble families were descendants of the Moors of the very earlier centuries who had been bred out until the black man finally disappeared by mating with whites only. He wrote:

No ethnologist could detect the presence of other blood, and yet in both cases, the male descendant would bear the surname signifying "the black man" ... you may see faces of a distinctly Mongolian and even of a Negroid cast in families whose pedigree may be traced for many generations without disclosing the slightest hint of extra-British blood ... so far as complexion goes there can be no doubt as to the presence of a vast infusion of "coloured" blood. There are of course, no living Britons who are as black as negroes but some are as dark as mulattoes and many darker than Chinese. To regard ourselves in the mass as a "white people" except in a comparative degree, is quite a mistake.

The families with the name of Moor, Moore, Morris, Morrison, too, and other derivatives of Moor, had Moors as their ancestors, stated David McRitchie. Families with Moors in the coats-of-arms ranged from Sicily to Finland, and included Britain, France, Germany, Holland, Italy, Switzerland, Poland, Denmark and Sweden. McRitchie was convinced that some African blood was also mixed with Norman blood, which is the last word in British "blue blood." Listed among those were the Morrises, Fitz-Morrises and Mountmorrises (all variations of Moor). A noted writer on heraldry, Lower, says of these August families: "They are supposed to be of Moorish blood; their progenitors having come from Africa by way of Spain into various countries of Western Europe."

Not only did the Moors in their European conquests leave their learning, their culture and their arts. Their blood, the blood of Africa, was to remain and flow in the veins of many a European, be he aristocrat or commoner. Finally, it is left now to investigate, in some detail, that culture which these Islamic sons of Africa left for the benefit of Europe, particularly Spain, and even more so, Portugal. It is this African cultural heritage which set in motion the expansion of Europe.

European expansion on a global scale can be chronicled from the last years of the fifteenth century. By the coming of the next century the world known to western man had reached great proportions to span almost the entire earth's sphere. The explorers, Da Gama, Columbus, Cabot, Cabral, Magellan and many others had brought Europeans to the farthest reaches of this planet, setting in motion what has been called the global epoch of European expansion.

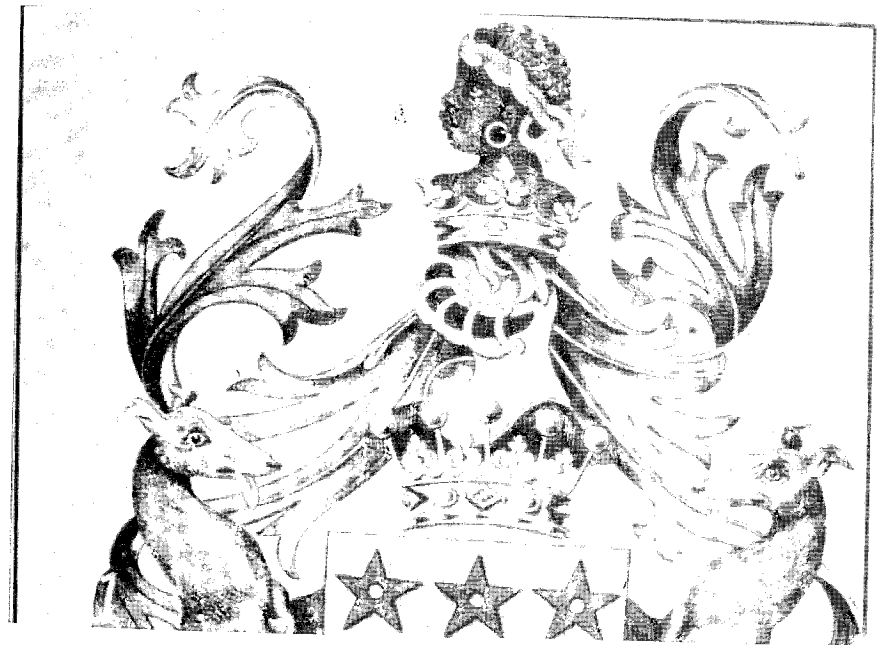

Figure 5. Family crest from Britain showing Moorish woman. Noble families depicted Moors on the coat-of-arms. Historian David Mac Ritchie shows that some of these noble families were descendants of the Moors.

When the reasons for this mammoth expansion in the sixteenth century are examined, certain explanations become crystal clear. To put it bluntly it was the part Africa played in providing the learning that triggered off this expansion. The culture of North Africa, the resources of Central Africa and the equipment of Moorish science set off a spate of explorations which culminated in the circumnavigation of the globe.

The great part played by Africa in supplying the learning which caused the expansion to take place has had little, if any, exposure in the writings of historians. The question was never posed as to why the Iberian countries were in the forefront of this global expansion. The British, the French, the Dutch and the Italians owned the ships that could undertake this journey. Their leaders also possessed the necessary vision for such an enterprise. Yet they did not take the lead. With respect to overseas expansion they were always trailing way behind the Iberians. One may well ask at this point why was that so? Put quite simply the answer is that the outstanding factor which set Spain and Portugal apart from their neighbors in the north was their most valuable inheritance from Africa. The rich cultural, artistic, and scientific knowledge they inherited from the Moors placed Spain and Portugal well ahead of the rest of Europe, still backward and living in the dark ages. More than that, the Moors (Arabs and Berbers) struck the blow which completed the decay of ancient Spain and established Moorish Spain. This Spain was to herald one of the brightest chapters in the intellectual history of Medieval Europe. Portugal, too, played an equal role in bringing this about. Professor Thomas T. Hamilton of Old Dominion University made this point clearly when he stated:

Between the middle of the eighth and the beginning of the thirteenth centuries the Arabic-speaking people (Moors) were the main bearers of the torch of civilization throughout the world, and were the medium through which ancient science was recovered, supplemented and transported through Africa, Spain, Sicily in such a way as to make the Renaissance possible.

Cordova, Seville and Toledo remained the centers of Moorish culture and science. Students from many countries of Western Europe were made welcome at the universities of these three cities. It was at Cordova that Gerbert of Aurillac gained mastery over mathematics. This caused him to introduce, when he became Pope Sylvester II, the use of Arabic numerals in the Latin West. The works of Aristotle first appeared in Europe through the Moors in Spain.

The center of scientific learning remained in Toledo even though it had been reconquered by Castile in 1085. There, many converted Moors and Jews translated several mathematical, astronomical and astrological volumes of the Afro-Arabs into Latin. It was in 1080 that Al-Zargali of Toledo produced a number of astronomical and astrological works. Included in these works was

a series of astronomical tables based on the work of a group of Afro-Arabs and Jewish predecessors. These studies, known as the Toledo Tables, contained not only astronomical material but geographical information, as well. They were translated into Latin in the twelfth century by Gerard of Cremona, who undertook most of this work in Toledo.

By then Portugal and Spain were far ahead of the rest of the European countries in intellectual attainments. This advance was made possible by the proximity of Africa to Spain and what has been rightly termed "the aggressiveness of the North African Berbers." It was these people of North Africa who brought this intellectual atmosphere and the advantages of their civilization, and so put those Iberian countries at the very front and caused them, indeed, to be the pioneers of European global expansion.

The invasion of the Moors on the Iberian Peninsula in 711 was unique in certain aspects. First, a few thousand men took over the government. Seven centuries later they were also driven out of the area by a few thousand armed men. In between those hundreds of years the majority of the population of both Spain and Portugal was left comparatively undisturbed. Professor Hamilton gives a very revealing account of the situation in Spain and Portugal during these seven hundred plus years:

The overwhelming majority of the people under the caliphs were the same people whose descendants were to discover the world for Spain and Portugal. The Christian rulers displaced the political and religious power of the Moslem rulers. The artists, scientists, writers and ordinary people were the holdovers connecting the two civilizations. The Mozarabs who took the lead in the economic and cultural life of the new Spain were not Arabs, but rather were African Berbers, who, as time went by, were assimilated into the basic Iberian stock. Furthermore, when the Christian princes regained the peninsula, the old civilization was not destroyed. Religious art, of course, was influenced adversely, but the actual scientific achievements were retained, and Toledo became a great translation center under the Castilians. While the rural districts continued their futile feudalism as they had both before and during the Moslem rule, the cities continued to bloom, thanks to the vitalizing influence of the Mozarabs and the Jews.

It was in this intellectually advanced civilization in 1394 that Prince Henry the Navigator was born. By that time and in the following century, Portugal was judged to possess a culture that had no equal north of the Pyrenees. This culture had travelled with the African Moors from Africa and came into full blossom mostly in Spain; but during the occupation, Portugal was an integral part of the Cordovan Caliphate. Eminent scholars have agreed that the talents of the Portuguese in geography and navigation have come out of this rich African heritage. In fact, long before the birth of Prince Henry the Navigator, the Spanish and African Moors had excelled in these sciences. Professor Hamilton explains why the Moors held pre-eminence in terrestrial mathematics

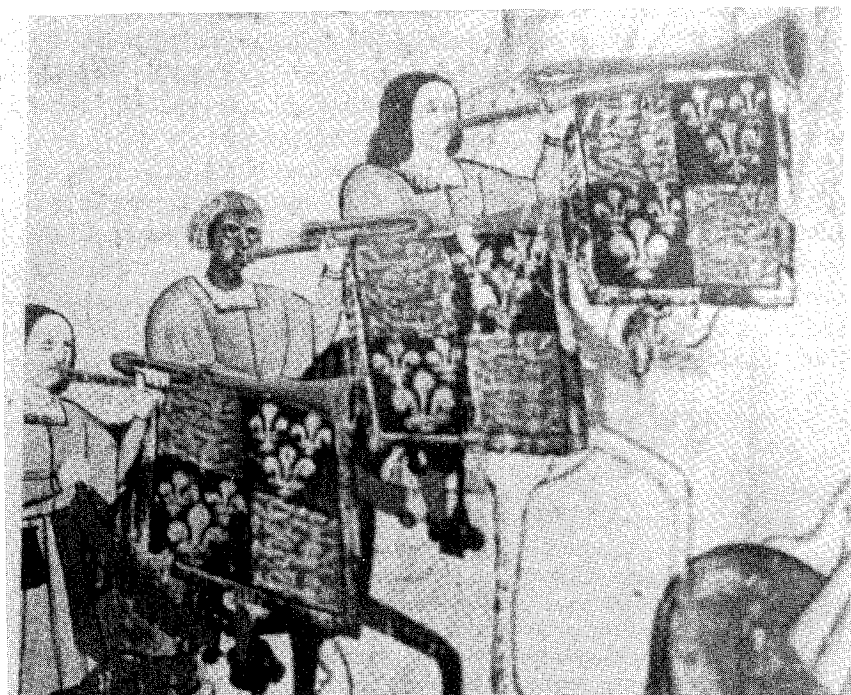

Figure 6. Royal Heralds on Horseback, summoning King Henry VIII and the challengers to a jousting tournament held on February 11, 1511 before his wife Queen Catherine. One of the trumpeters is a Moor. Moors were an everyday sight in Tudor England.

which is essential in the science of navigation, claiming that it could be traced to their religion:

Their faith required them to pray at a specified time each day in the exact direction of Mecca. In order for the devout moslem to accomplish this it was necessary for him to have the geographical coordinates of his location, just as a mariner must have his position. Thus did geodesy become an exact science in the world of Islam.

The Afro-Iberian Moors were responsible for almost all the geographical lore which the Europeans, primarily the Portuguese and Spanish, used in their global expansion. This knowledge was divided into three main categories: the systematic geographers and encyclopedists who incorporated the lore of the ancients with the discoveries of their contemporaries; the astronomers and geodesists who set out the groundwork for navigation and cartography; and, lastly, the travellers and collectors of travel accounts, thus providing the descriptions of the world. Through religion and trade the Muslim world placed great stake on travel; and more than any other peoples during those early centuries they travelled the length and breadth of the known world. By foot, camel, donkey and cows, Muslims entered remote lands. Of the travel accounts available at that time was the narrative of Ibn-Battutah, called the most widely travelled scholar of the middle ages. In the fourteenth century he traversed the entire span of Muslim countries, from China to Guinea.

Another Moorish writer, Ibn-Hawkel, who wrote during that time, said that slaves, ivory and gold dust were important items in the Mediterranean trade. Up until the advent of the Moslem writers', written information about Africa was very scant indeed. It was these scribes who caused information about Africa and travel to its interior to reach European ears, especially the people of Iberia and Sicily. One such traveller with whose writings Prince Henry was very familiar, was Ibn-Battutah. In the year 1352 Battutah penetrated the interior of Africa and produced the most complete portrait of the African peoples up to that time. Battutah had meticulously kept a chronological narrative of his Travels, and noted how very well he got on with the local rulers in the areas that he visited. He made mention on several occasions of having received gifts of gold dust from the African monarchs. This knowledge proved to be of great value, not only to Prince Henry, but to the other Iberian explorers who were to claim vast land masses for Portugal and Spain.

It was in the fifteenth century that the precious metals in Europe had been drastically depleted due to the demands of enormous foreign trade and the very costly wars that had been fought and were still taking place. During that period due to the limitation of camel travel, bulky goods from the west could not stand the heavy cost of being carried to the East. The valuable goods from India, China and the Spice Islands, which were taken overland, had to be paid in gold and silver. In the past, Europe could depend on her own mines, but

with the depletion due to the costliness of her wars, her merchants traded with Barbary using gold taken from Guinea. Consequently, it was not surprising that with her gold shortage, yet still requiring that precious commodity, Europe would turn to Africa as an untapped source of supply. It was this shortage of gold and other precious metal in Europe which prompted their penetration of Saharan Africa.

Prince Henry and all his scholarly associates had great knowledge of this information about the science of the Afro-Iberian Moors. The Portuguese explorers became well aware that it would be the riches of Africa that would supply the vast amounts of gold needed by the crown of Portugal. It was these two factors which were the primary objectives for the Portuguese exploration of the lands of Africa and the Indies. These motives remained of paramount importance until the death of Prince Henry in 1460, and after. Professor Hamilton concluded that "The background of the African Moor and the lure of African gold broke the fetters that bound the European to Europe."

Much praise was heaped on the royal head of Prince Henry for the great part he played in the early Portuguese explorations. He has even been immortalized in the volumes of history as "Prince Henry the Navigator." But, what remains minimized and almost unwritten in the pages of the history of Europe and its global expansion is the very vital role that the Moors played. For, without their scholarly writings and their extensive mastery of the sciences of navigation, cartography, astronomy and mathematics, the voyages of the Portuguese and Spanish would not have taken place then. Yet Prince Henry has reaped all the glory. In talking about this, Professor Hamilton throws true light on this legend and gives honor where honor is due:

Prince Henry ... had swept away from the minds of even the legends of the unearthly terrors which had hitherto precluded voyages into the unknown. He had proved the feasibility of Atlantic travel and had provided and perfected the ships and instruments to reduce the actual dangers to be encountered. Diaz, Columbus, Da Gama, Cabral, Vespucci and Magellan were fruit of the tree planted by Prince Henry. The chains were broken by the lore and lure of Africa. Africa not only influenced European expansion; it determined it.

The influence of the Moors ranged further afield in Europe; and it has also been ignored by European writers after the Africans were driven back eventually to Africa. Some honest historians have deplored this behavior and sought to include the whole story of the conquest of Europe by the Moors in their annals. One such scholar was John William Draper, Professor of Chemistry and Physiology at the University of New York in the latter years of the nineteenth century. In his classic work *History of the Intellectual Development of Europe*, published in 1864, Draper stated clearly:

I have to deplore the systematic manner in which the literature of Europe



Figure 7. The famous Rosa dos Ventos, the rudimentary compass of stones constructed by Prince Henry the Navigator at Sagres to instruct the explorers he was sending to sea. Prince Henry's navigational knowledge owes an immense debt to the travel documents, the cartography and nautical instruments of the Moors.

has contrived to put out of sight our scientific obligations to the Mohammedians. Surely they cannot be much longer hidden. Injustice founded on religious rancour and national conceit cannot be perpetrated forever.

The list of Moorish achievement is endless. Dr. Draper asks:

What should the modern astronomer say when, remembering the contemporary barbarism of Europe, he finds the Arab Abdul Hassan speaking of tubes, to the extremities of which ocular and object diopters, perhaps sights, were attached, as used at Meragha? — What, when he reads of the attempts of Abderahman Sufi at improving the photometry of the stars? Are the astronomical tables of Ebn Junis (A.D. 1008) called the Hakemite tables, or the Ilkanic tables of Nasser Eddin Tasi, constructed at the great observatory just mentioned, Meragha, near Tauris, A.D. 1259, or the measurement of time by pendulum oscillations, and the methods of correcting astronomical tables by systematic observations — are such things worthless indications of the mental state? The Arab (Moor) has left his intellectual impress on Europe, as, long before, Christendom will have to confess; he has indelibly written it on the heavens, as anyone may see who reads the names of the stars on a common celestial globe.

In other fields of development, the Moors left Portugal and Spain far ahead of the rest of Europe. They set an example of skillful agriculture, cultivating plants, introducing many new ones; breeding cattle and sheep and fine horses. To them Europe owes the introduction of products like rice, sugar, cotton; and all the fine garden and orchard fruits, together with many less important plants such as spinach and saffron. The culture of silk was brought by the Moors; and they gave to Xeres and Malaga their knowledge of wine-making (something for which the two Iberian countries have earned a world-wide reputation). But the story does not end here. The Moorish conquerors introduced the Egyptian system of irrigation by flood-gates, wheels and pumps. They also promoted many vital branches of industry; improved the manufacture of textiles, fabrics, earthenware, iron, and steel; the Toledo sword-blades were valued everywhere for their power. On their expulsion from Spain and Portugal, the Moors carried the manufacture of a kind of leather, in which they were acknowledged to excel, to Morocco. It is known throughout the world for its excellence as Moroccan leather.

The Moors also introduced inventions of a more ominous nature — gunpowder and artillery. The cannon they used appears to have been forged from wrought iron. But of more value to Portugal and Spain was the introduction of the mariner's compass; something which aided the explorers of Iberia to gain control of vast expanses of the New World.

Armed with the gun, its manufacture made possible by gunpowder brought by the Moors, and with their ships using lateen sails, astrolabes and nautical compasses, all the inventions of the Afro-Arab Moors, the Portuguese and

Spanish set sail to rob the resources of others. In the words of a Ghanaian scholar, Samuel Kennedy Yeboah, "The Europeans unleashed a concerted and, in some cases, genocidal (e.g. the aborigines and some of the Amerindians) onslaught against the rest of the world."

What were Spain and Portugal like when the illustrious Moors were finally driven off from these Iberian lands? They left farming, the arts, sciences; beautiful cities with magnificent buildings, gardens, streets and a culture and civilization far surpassing that of the rest of Europe. The city of Cordova, under their administration, at its highest point of posterity had more than 200,000 houses and over a million inhabitants. At night one could walk through it in a straight line for ten miles by the light of the public lamps. Seven hundred years after this time there was not as much as one public lamp in London. The streets of Cordova were solidly paved. In Paris, centuries later, whoever walked over his threshold on a rainy day would be covered in mud right up to his ankles. Other Iberian cities like Granada, Seville, Toledo, Lisbon, considered themselves rivals in magnificence with Cordova. The palaces of the Khalifs were handsomely decorated.

But this beauty, this culture, this civilization was not to last very long under the barbarous handling by the Christians of Aragon, Castile and Portugal. They defiled the holy name of religion with its intrigues, its bloodshed, its oppression of human thought, its hatred of intellectual advancement. This condition of destruction and decay is painstakingly described in the words of Stanley-Lane Poole in his classic "The Story of the Moors in Spain":

In 1492 the last bulwark of the Moors gave way before the crusade of Ferdinand and Isabella, and with Granada fell all Spain's greatness. For a brief while, indeed, the reflection of the Moorish splendor cast a borrowed light on the history of the land which it had once warmed with its sunny radiance ... Then followed the abomination of desolation, the rule of the Inquisition, and the blackness of darkness in which Spain had been plunged ever since ... and beggars, friars and bandits took the place of scholars, merchants and knights. So low fell Spain when she had driven away the Moors. Such is the melancholy contrast offered by her history.

The Moorish contact with Portugal was to have more dire consequences for Africa and African peoples. To begin with the effects of Muslim civilization on Europe, particularly Portugal, is closely linked to the effort to reconstruct the processes by which the African past was extracted from European consciousness. There is little doubt that one of the greatest ironies of this history was the founding of the Portuguese state and the elite class that ran it. The "Age of Discovery," which Portugal, initially from the learnings of Prince Henry, extracted and copied from Muslim scholarship, marks the beginning of the modern era in European development. This expansion of the Portuguese into Africa and the New World set in motion the encounters between



Figure 8. Prince Henry the Navigator.

the peoples of the European peninsula and the African peoples. This was to lead into the Atlantic Slave Trade and Slavery, two of the greatest disasters which Africans suffered, and from which they have not yet recovered. One scholar went as far as to claim that this catastrophic meeting was to “produce the Negro.” It was at this point that the stereotype first showed its face on the map and the histories of Europe.

What has been ignored by Eurocentric historians — and this is a deliberate act — is that the beginning and the formation of the Portuguese state were the results of processes both directly and indirectly related to Muslim civilization. Prince Henry the Navigator has been credited with harnessing the energies of Portugal and the resources of the Order of Christ with the skills, the instruments, the most developed seamanship, the navigational wisdom — all copied and learnt from Muslim mathematicians, cartographers, astronomers and geographers. Where and from whom this ascetic, celibate and reclusive son of Joao of Avis and his English-born queen, Philippa, accumulated this vast reservoir of scientific and navigational knowledge has always been played down or ignored out of hand. Portugal has always gone to great lengths to believe that its development and expansion into the rest of the world has been a history of its own doing without Muslim impact; and has believed that story with such intensity that she was quite successful, bit by bit, in incorporating both an imagined history and the habit of always feeding it into the process of her authentic existence. That is why it has been claimed that all Portugal’s imperial enterprises; the lasting effect of Portugal in Brazil, in the East Indies, and in Africa; the celebrated figures of Vasco de Gama, Alfonso de Albuquerque, Ferdinand Magellan, and others; the works of Gil Vicente and Camoens — have all been the elements that have motivated the creation and recreation of the origins of Portugal. Without the knowledge, intellect, learning and artistic brilliance of the African Moors, this Renaissance Portugal would have never, and I repeat never, come about.

But, this is a condition or reality which relates not only to Portugal, and Spain, but the rest of the latecomers of Europe, as well. Eurocentric scholarship cannot come to grips with this fact of history; and therein lies its tragedy. It is absolutely no exaggeration to state categorically, that Islam had provided for, not only Portugal and Spain, but the rest of emerging Europe a powerful, economic, scientific, artistic, political impulse; an impulse which led to European domination of the world. Eurocentric scholars boast that the Renaissance aroused Europe from its Dark age slumber. And they stop at this blank, empty statement which has no Caucasoid base on which to stand. They shy away from the truth, the total truth that but for Muslim knowledge this awakening would never have come about; certainly not at the time that it did.

It is lamentable that the European foray into Africa and other lands across the seas was initiated by Portugal using the knowledge gained from Africans in order to conquer, colonize, rape, exploit, oppress, maim and murder other

Africans they had captured and chained in the prison plantations of slavery. The Moors themselves who were banished from Portugal and Spain suffered the same horrible fate that their descendants were to endure.

How were the Moors recompensed for their phenomenal contribution in civilizing Spain, Portugal and other areas of a Europe steeped in barbarism and darkness? The nineteenth century English scholar, Stanley Lane-Poole, paints a picture of European savagery of the lowest form in their genocide of the Moors. 50,000 of them were brutally murdered on the famous Day of All Saints, 1570, when the honor of the apostles and the martyrs of Christendom was celebrated by the virtual martyrdom of these Moors ... No less than three million Moors were banished by the first decade of the seventeenth century. To use the words of the Franciscan priest Bartholomew Las Cascas, during the Columbian era, when these dastardly deeds were being perpetrated on the Moors, "Moloch must have been in the skies."

Spain and Portugal did not escape retribution. Where once wit and learning flourished, a general stagnation and degradation had fallen on their people and lands. Historians are agreed that they deserved their humiliation. Such is the terrible price that Spain and Portugal had to pay for their treatment of the Moors. As Stanley Lane-Poole concluded: "They did not understand that they had killed their golden goose."

Bibliography

- Barashango, Ishakamusa. *African People and European Holidays: A Mental Genocide*, Washington, D.C.: IV Dynasty Publishing Co., 1983.
- Bennett, Norman R. *Africa and Europe*. New York: Africana Publishing Co., 1975.
- Bovill, E.W. *The Golden Trade of the Moors*. Rev. ed. London: Oxford University Press, 1970.
- Cox, George O. *African Empires and Civilizations: Ancient and Medieval*. New York: African Heritage Studies Publishers, 1974.
- Davidson, Basil. *Discovering Our African Heritage*. n.p.: Ginn & Co., 1971.
- DeBrunner, Hans Werner. *Presence and Prestige: Africans in Europe*. n.p.: Basler Afrika Bibliographien, 1979.
- DeGraft-Johnson, J.C. *African Glory: The Story of Vanished Negro Civilizations*. 1954; rpt. Baltimore: Black Classic Press, 1986.
- Draper, John William. *History of the Intellectual Development of Europe*, Vol. 2. London: Bell & Dalby, 1864.
- Hamilton, T. "The African Heritage in European Expansion," *Journal of Ethnic Studies* (Sep. 1976).
- Jackson, John G. *Man, God, and Civilization*. New Hyde Park: University Books, 1972.
- Jackson, John G. *Ages of Gold and Silver*. Austin: American Atheist Press, 1990.
- Lane-Poole, Stanley. *The Moors in Spain*. 1887; rpt. Baltimore: Black Classic Press, 1990.
- Livermore, H.V. *The Origins of Spain and Portugal*. London: n.p., 1971.
- MacRitchie, David. *Ancient and Modern Britons: A Retrospect*, Vol. 1. London: Kegan Paul, Trench, Trubner, 1884.

- Read, Jan. *The Moors in Spain and Portugal*. Totowa, NJ: Rowman & Littlefield, 1975.
- Robinson, Cedric J. *Black Marxism*. London: Zed Press, 1983.
- Rogers, Joel A. *Sex and Race*, Vol. 1. New York: Rogers, 1940.
- Rogers, Joel A. *Africa's Gift to America*. New York: Rogers 1959.
- Rogers, Joel A. *Nature Knows No Color-Line: Research Into the Negro Ancestry in the White Race*. 3rd ed. New York: Rogers, 1952.
- Rogers, Joel A. *World's Great Men of Color*, 2 Vols. New York: Collier, 1972.
- Scobie, Edward. "Africa in Portugal." *Flamingo* (Feb. 1962).
- Scott, S.P. *History of the Moorish Empire in Europe*. London: J.P. Lippincott, 1904.
- Townson, Duncan. *Muslim Spain*. n.p.: Lerner Publications Co., 1979.
- Williams, Chancellor. *The Destruction of Black Civilization*. Rev. ed. Chicago: Third World Press, 1976.
- Windsor, Rudolph R. *From Babylon to Timbuktu*. New York: Exposition Press, 1969.
- Woodson, Carter Godwin. *African Heroes and Heroines*. Washington, D.C.: Associated Publishers, 1939.

AFRICANS IN THE BIRTH AND SPREAD OF ISLAM

Mamadou Chinyelu

Introduction

Little is known about the role that black Africans played in the Moorish conquest and eight hundred years of Moorish rule in the Iberian Peninsula. It is also largely unknown that Africans played crucial and seminal roles in the early development of Islam and its spread across north, east and west Africa. Yet, historical evidence reveals that black Africans not only participated in both of these monumental historical events, but were pivotal to their success.

In the following essay, we will explore important cultural, religious, scientific and military contributions that black Africans made to Islam and, in particular, the role they played in Moorish Spain.

Africans in the Islamic Tradition

Since the revelation that inspired Mohammed in 622 A.D., Africans have been pivotal figures in the development of the Islamic faith. In fact, there is no time in the history of the faith that Islam can be disassociated from Africans. African blood figures in Mohammed's lineage and Africans in his upbringing and development. Washington Irving, in his *Life of Mohamet*, says that Mohammed was reared by Barakat, an African woman, after the Prophet's mother died.¹ D.S. Margoliouth says of the sons of Abd al-Muttalib, Mohammed's grandfather, that, "all ten sons ... were of massive build and dark colour."² It is also a fact that Mohammed's first convert was Bilal, an Ethiopian. J.A. Rogers calls Bilal, Mohammed's "closest and most honored friend until his death," and goes on to say that most of the earliest disciples were Africans, including another convert, Zayd bin Harith, the Prophet's adopted son and one of his great generals.³

The close proximity of Arabia to Africa would also suggest that there were ample opportunities for an interchange of peoples, religion and custom. Drusilla D. Houston asserts that, "Arabia was originally settled by two distinct races, an earlier 'Cushite Ethiopian' race and later Semites. The Cushites were the original Arabians."⁴ Not only were the Ethiopians the original inhabitants of Arabia, but, according to Cheikh Anta Diop, Africans were the only inhabitants "prior to the eighteenth century B.C."⁵ Houston puts



Figure 1. The Moors are here engaged in battle with forces led by Charles Martel, the Frank, at Poitiers (southern France) in 732 A.D. Though the Moors lost the battle, they entered France in 716 A.D. and controlled the southern portion of that country until 1140 A.D. This illustration comes from a Middle Ages manuscript.

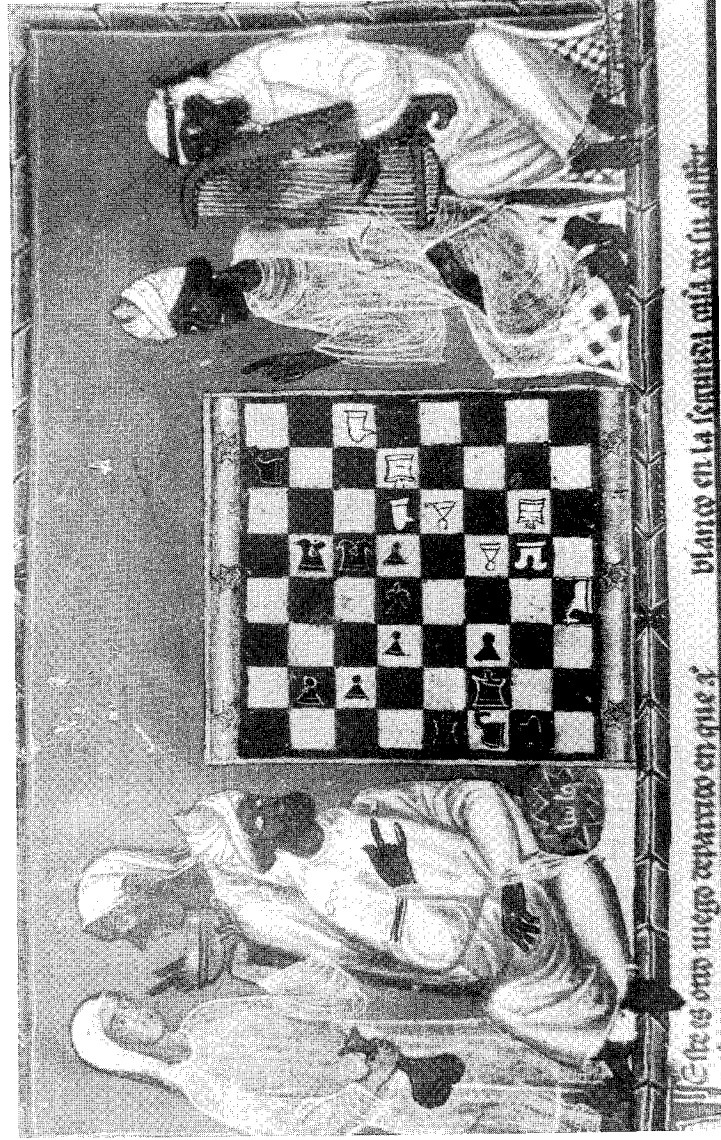

Figure 2. *Ya, Shah (Oh King!)*, which signifies a challenge, is better known today as *chess*. The Moorish Caliph Harun al Rashid gave Charlemagne, first emperor of the so-called Holy Roman empire, a chess set in the ninth century. Here we have a thirteenth century illustration (from the manuscript of Cantigas de Alfonso X) of a leisure class of Moors in Spain playing chess and being served by both white and black servants.

the arrival of the Semites in Arabia at an even later date, at about 1300 B.C.⁶ Moreover, one ancient map of Africa, drawn in the basis of Herodotus' description of Africa, made in 450 B.C., has Arabia as a prominent part of the continent.⁷ And the question must be asked: Are the "Two Shores" mentioned in *The Teachings of Ptahhotep* (first published about 2500 B.C.)⁸ a reference to the two shores of the Red Sea, which separates Africa from Arabia?⁹ Perhaps, the meaning of the "Two Shores" is esoteric, such as the 'duality and harmony of opposites?' It is unlikely that it is a reference to the two shores of the Nile River. Even with the arrival of the Semitic Arabians around 1300 B.C., the current inhabitants of that land, it is inconceivable that all of the African presence subsequently vanished from Arabia. In fact, today, Arabia is known as "Saudi Arabia," named in honor of Abdul Aziz Ibn-Saud, who Rogers says was a man of African descent living from 1880 to 1953 and known as "the foremost man in the Arab world of his time."¹⁰

It was during the Semitic rule of Arabia that Islam emerged. By that time, the Semites or Indo-Europeans had been in Arabia for nearly 2,000 years. Yet, the question remains: What did the Semites contribute to the culture of Arabia? Godfrey Higgins says that, "it is clear that the African Ethiopic and Arabic have originally been identical."¹¹

Edward Wilmont Blyden says of Mohammed, "when in the early years of his reform, his followers were persecuted in Arabia, he advised them to seek asylum in Africa. 'Yonder,' he said ... 'Yonder lieth a country wherein no man is wronged — a land of righteousness.'"¹² When the Islamic converts invaded Egypt, it was ruled by the Eastern Roman Empire, the Byzantines. The Byzantine oppression of the Africans gave the Ethiopic Arabian Muslims the popular support and, hence, leverage they needed to challenge the Europeans. According to Du Bois, "the Arabs invaded African Egypt, taking it from Eastern Roman Emperors and securing as allies the native Negroid Egyptians, now called Copts, and using Sudanese blacks ... in their armies [and] One of Mohammed's wives was an African woman named May."¹³

Apparently, it was not religion that put the Byzantines and Muslims at odds with one another, because both Christianity and Islam are fundamentally alike. Rather, it was the cultural differences as seen in the different ways in which Christians and Muslims interpreted their sister religions. In discussing the common origins of the two, Du Bois says, "Byzantium, through Constantinople, handed Greek culture back to Asia and Africa, whence it came. At Baghdad and Alexandria and Cairo it flamed anew under Islam. It was not 'Arabian'; the nomad Arabs carried culture but seldom originated it."¹⁴ Here, we must be reminded, Du Bois is referring to the Semitic Arabian, because there is ample evidence that the Ethiopic Arabian, the Africans, contributed much to the culture of Islam. For example, there was the poet Antar, who was an Ethiopic Arabian, so black that his nickname was *Gharab*, 'the crow.'¹⁵ Antar accomplished great feats as a warrior and poet in pre-

Islamic Arabia. One of his poems was accorded the highest honor possible for an Arabian writer. Though he was not a Muslim, his work hangs among the seven poems at the entrance of the mosque at Mecca. This collection of seven poems, known as the *Moallakat*, are cherished by those of the Islamic faith.¹⁶ Of slightly less reverence, although no less important, are, as Du Bois says, "Black historians, like Abderrahman Es-Sadi," who wrote the "Bible of the Sudan," the *Tarikes-Sudan*; and the *Tarikh-el-Fettach*.¹⁷

The Spread of Islam in North Africa

Ten years after the death of Mohammed in 632 A.D., the Muslims conquered Egypt and from there, conquerors armed with the sword and the Koran, marched triumphantly across North Africa.

By the time Islam began to spread from east to west, North Africa had already suffered from the comings and goings of other conquering elements beginning around 822 B.C. with the Phoenicians. Prior to their arrival, however, it would appear from the writings of Herodotus and archaeological finds, that North Africans had enjoyed a high degree of civilization, a testament to their long history of peace and harmony. While describing the Eastern Ethiopian empire as being the same as Arabia, Herodotus also states that the Western Ethiopia empire stretched as far west as present-day Sierra Leone and Liberia.¹⁸ Herodotus, himself, lived in the fifth century B.C. and the period to which he refers was 1800 B.C., the same time when Africans inhabited Arabia according to Rogers and Houston.

Archaeologists have also discovered cave drawings in North Africa which they have dated to a period prior to the Christian era. The subjects of these drawings are clearly African. Although there are no facial features in two of them, the voluptuous buttocks of the women reveal their African identity.¹⁹ These drawings depict people herding cattle, making fire, children playing, and a woman and man on an animal-drawn cart, waving to two women and a child as a dog scampers ahead of the cart. There are no Europeans in these drawings, nor is there any evidence that the people in the drawings are subject to the rule of others. The third drawing is of a man carrying a sheep on his back, straddling his shoulders. Both the sheep's wool and the man's hair and full beard are represented as having the same coarse texture, like that of Africans.²⁰

The invasions of conquering armies began with the Phoenicians, a seagoing people, who sailed from Canaan (present-day Palestine). The name "Phoenician," itself, is the name the Greeks gave to the Canaanites.²¹ And according to the Biblical tradition, Canaan was the son of Ham, the African. Thus, the Phoenician invasion was, in essence, one of one group of African people assuming power over another. Rome supplanted Phoenician rule of North Africa in 146 B.C., and maintained its dominance until 430 A.D., the



Figure 3. Caspar, a fifteenth century African altar boy, of the Cisterian abbey at Lichtenthal in Baden-Wurttemberg, in the Upper Rhine region of Germany. The Moorish presence in southern Europe was felt throughout Europe.



Figure 4. Here is the highly celebrated portrait entitled “Juan de Pareja” by the seventeenth century Spanish artist Diego Velasquez. In the Spanish language “pareja” means partner, so it is possible that Juan was also an artist. Velasquez, who was commissioned to do a portrait of the Roman Catholic pope, did this portrait of Juan as preparation for the commission.

year the Vandals, a Germanic tribe, made their first conquests in North Africa. The Vandals remained in power until 530 A.D., when the Eastern Roman Empire, the Byzantines based in Constantinople (present-day Istanbul), reconquered it in the name of the Roman Empire. Except for a brief ten-year period (619–629 A.D.), when they lost control to the Persians, the Byzantines dominated the region until 642 A.D., when the followers of Islam appeared.

It must be noted that prior to the Islamic invasion, the Egyptian African population, which was in the majority, suffered greatly from the religious intolerance of the Christians (Byzantines) and Zoroastrians (Persians). J.C. deGraft-Johnson says that the Coptic Church was the “true expression of African nationalism.”²² He quotes H.G. Wells as saying that, “In both Persia and Byzantium it was an age of intolerance. Both empires were theocratic empires, the fundamentalists of an earlier age, whose narrow focus greatly hampered the free activities of the human mind.”²³ These African Copts no doubt saw the African Muslims from Arabia as liberators; after all they were kith and kin. Blyden also makes note of the fact that Mohammed never spoke of a curse on Africa or Africans, unlike the Christians and their infamous curse put on the children of Ham.²⁴

With the many incursions into North Africa over a period of 1,400 years, one question seems more prominent than others: How did these invading populations affect the racial makeup of the North Africans? J. Desanges says that the African population was not whitened by these invasions. In assessing the racial impact, he writes,

... it would not seem that the Phoenician and Roman demographic accretions were of any consequence.... It is unlikely ... that the Carthaginians would have such a constant recourse to mercenaries on the battlefield if those of Phoenician origin had been more numerous. The demographic contribution of the Romans is also difficult to evaluate. The number of Italians settled in Africa in the time of Augustus, when colonization was at its peak, has been estimated at 15,000.... In our view some 20,000 colonists would be the maximum for the Augustian period, for Roman Africa was in no way a mass-settlement area. The demographic contributions of Vandals and Byzantines were undoubtedly far more modest.²⁵

Of all the conquerors of North Africa, the Vandals alone were not colonizers whose kith and kin remained in a home country. Their total population migrated to Africa. But, deGraft-Johnson says that, the Vandals probably had less impact on racial amalgamation in North Africa than did the other groups: “It is said that the Vandals remained a distinct group; that they never merged into another society nor were transformed or modified by travel, but kept themselves always apart, and that eventually, through their very inability to adapt, they perished.”²⁶

What is apparent thus far, is that after conquerors came and went, the North

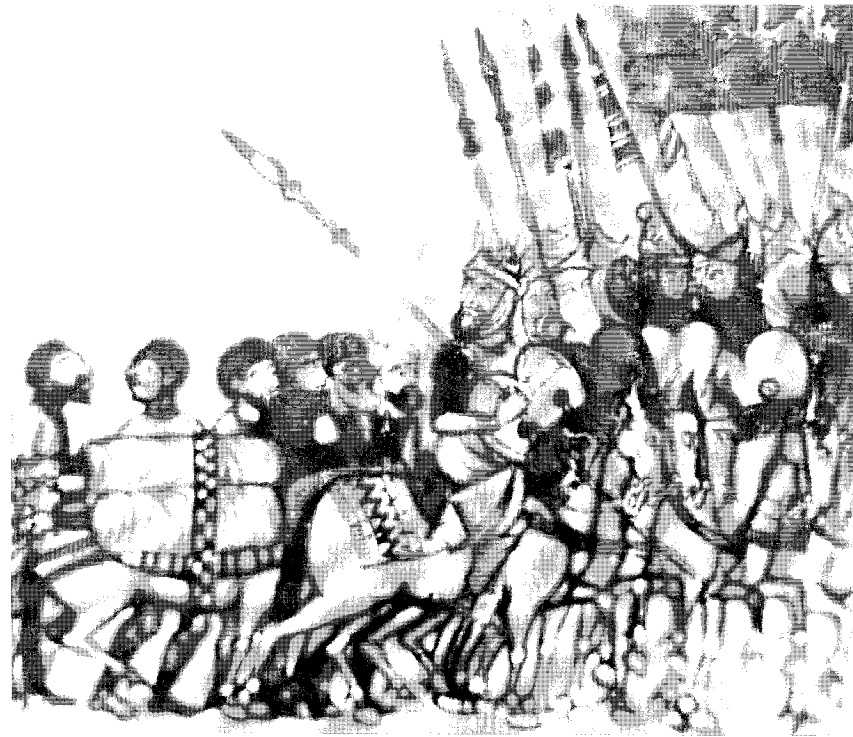

Figure 5. "Moorish Army in Retreat" is the title of this thirteenth century illustration. It comes from the manuscript of the *Cantigas de Alfonso X*, the original of which can be found in the Escorial Library in Spain. The *Cantigas* is a collection of 400 poems to be set to music, primarily written by Alfonso X, a thirteenth century king of Castile, who was nicknamed "the wise."

African racial identity had not been fundamentally altered. In fact, according to Rogers, "even as late as the fifth century A.D. Procopius, Roman historian, calls the people of Morocco 'black.'"²⁷

One major problem encountered in recovering Africa's history is that Africans throughout their long and varied existence have been known by a countless number of names. 'Berber' is one such name. When the Africans in the northern part of the continent first assumed the name is not certain, but by the time of the Islamic conquest, this name was in common usage. Reinhart Dozy says that the name 'Berber' was applied to, "the people of Africa especially — that agglomeration of heterogeneous elements which the Arabs found established from Egypt to the Atlantic."²⁸ And Rogers says that, "The Berbers claimed descent from the Mazoi, the Negro soldiers of ancient Egypt."²⁹

It was these Berbers, converts to Islam, who conquered Spain in 711 A.D. Thomas Arnold and Alfred Guillaume say of that conquering army that, "The



Figure 6. General Bassa, one of the great military figures in Mulai Ismael's army. Mulai Ismael needed such great military leaders. According to J.A. Rogers in *Nature Knows No Color Line*, Mulai Ismael's path to the throne was not easy. On the death of his brother Rashid, he was forced to fight his nephew, Achmet. The contest between them was long and bloody, Mulai Ismael finally defeating Achmet in a great artillery battle and capturing him. The drawing of Bassa was done during the general's life.

leader of the first successful expedition into Spain, Tariq (Tarik), was not an Arab but a Berber, and so were a large portion of his followers; the actual figures given are 300 Arabs and 7,000 Berbers.³⁰ Dozy supports this dominant role but puts the Berber numbers at 5,000 more than Arnold and Guillaume — 12,000. He says, “The Berbers had been the true conquerors of the country [Spain]. Musa and his Arabs had merely reaped the fruits of the victory gained by Tarik and his twelve thousand Berbers over the army of the Visigoths.”³¹ Du Bois says that once these Berbers conquered Spain, the Europeans began to refer to them as ‘Moors’, as in ‘Blackamoors’ and ‘Tawny Moors.’³² This is in keeping with other European languages, such as German *Mauren* and Dutch *Moorrees*. Rogers says that, “to the earlier Greeks, the Moors were ‘a black or dark people’ (Mauros) and to the Romans, Maurus, a black and woolly-haired people.”³³

Interestingly, in the fourteen century, Duarte Barbosa of Portugal refers to the black people he encounters when travelling along the coast of East Africa — near the border of Kenya and Tanzania — as ‘Moors.’³⁴ East Africa also became a part of the Islamic empire. Dar es Salaam, the capital of Tanzania, means “the land of Islam.” Thus, it would appear that these Africans were of the same people as those who lived in Barbosa’s native land.

These Moors, the African Muslims, not only provided the rank and file of the conquering Islamic army, but also the leadership.

Moorish Leaders in Spain

The eight hundred years of Moorish rule of Spain undoubtedly produced innumerable outstanding personages. But, three, in particular, stand out more than any others: Tarik, who brought Moorish rule to Spain in 711 A.D.; Yusuf ibn Tashifin, leader of the Almoravids, another African Muslim group who assumed the rule beginning in 1086 A.D.; and Yakub Al-Mansur, leader of still another African Muslim group, the Almohades (unitarians), who replaced the Almoravids in 1194 A.D.

The fact that Rogers does not include a biography of Tarik in his *World’s Great Men of Color*, published in 1946, raises some questions about Tarik’s ancestry, particularly since some scholars contend that Roger’s criteria for establishing African ancestry is sometimes less than sound. Rogers’ detractors conclude, therefore, that even he could not find the thinnest of evidence to assert Tarik’s African ancestry. But, in two later works, Rogers does say that Tarik is an African.³⁵ It must be concluded, then, that Rogers had not yet documented this fact by 1946, and, not willing to risk his credibility, did not include Tarik in the volume. Interestingly, though he subsequently reaffirms Tarik’s African ancestry, he does not give any references. Still, other scholars have supported him. Du Bois says that Tarik is of African descent.³⁶ DeGraft-Johnson refers to Tarik as an African no less than five times.³⁷ Arnold and

Guillaume call Tarik a ‘Berber.’³⁸ And Dozy describes Tarik as a ‘Berber,’ “the people of Africa ... which the Arabs found established from Egypt to the Atlantic.”³⁹

Shortly after the Islamic conquest of North Africa in 708 A.D., Tarik was placed in charge of Morocco by the Muslim governor, Musa ibn Nusair. Tarik’s protectorate included all but Cueta, a city-state near present day Tangiers, which was ruled by Count Julian. Julian had been allied with Spain, which was then under the rule of the Visigothic King Roderic — that is, until Julian accused King Roderic of raping his daughter. To avenge this act, Julian encouraged Tarik to invade Spain. After having received permission from Musa in 711 A.D., Tarik took a scouting force to Spain to assess the prospects of an invasion. And while there, he decided to attack Roderic and proceed



Figure 7. Mulai Rashid was emperor of Morocco from 1631 to 1672. J.A. Rogers called this portrait of Rashid an “authentic portrait.” After him, his brother Mulai Ismael, ruled Morocco, with General Bassa as the leading military figure. All of these men were indisputably African. While there is no “authentic portrait” of Mulai Ismael, there is an eyewitness account of his appearance by Abbe Busnot, a Frenchman who met him as an emissary of the French monarch, which account describes him thus: “He is of middle size; his face is long and thin, and his beard, forked and white; his color, almost black with a white mark near the nose; his eyes full of fire...”

with the conquest of Spain.⁴⁰ Tarik's forces were heavily outnumbered by the Visigoths, but rather than retreat back to Africa, Tarik rallied his legions. "Men, before you is the enemy and the sea is at your backs. By Allah, there is no escape for you save in valor and resolution." His men proclaimed their support for Tarik, saying, "We will follow thee, O Tarik." Roderic was killed and his army defeated.⁴¹

Tarik took Spain in the name of the Islamic empire and, in the process, his name was immortalized with a mountain, Gebel Tarik (hill of Tarik or Gibraltar), named in his honor. Dozy says that Musa was jealous of Tarik's conquest, having planned to lead the conquering army himself and he reprimanded Tarik, saying, "Why has thou advanced without my permission? I ordered thee only to make a foray and immediately to return to Africa."⁴²

All of Spain was conquered by the Moors. According to Arnold, the Moors were welcomed not only by the slaves in Spain, but also by the lower and middle classes, and the Jews, all of whom were severely persecuted by the Christian Visigoths. In fact, except for the Jews, many of the other oppressed Spaniards, including many Christian noblemen, converted to Islam.⁴³

Parts of other European regions were conquered by the Moors as well:

Seven years after the capture of Gibraltar the Moors invaded France; and conquered and overran most of its southern portion. They probably went as far as Geneva. Switzerland was then a part of France They remained in Southern France, however, until 1140 Aided by fellow Moslems from the East they captured Sicily in 837 and took a million pieces of gold. In 846, they invaded Italy, seized Rome, plundered the Vatican and St. Peter's Cathedral and carried off immense wealth in gold, jewelry, tapestry, and paintings. Later with Jews as intermediary[ies], they sold back much of this loot to the Pope.⁴⁴

Thus, it was Tarik who paved the way for the eight-hundred-year Moorish domination of Spain. Although Tarik, himself, never ruled Spain, other Moors did. One of the most celebrated of these Moorish rulers was Yusuf ibn Tashifin.

Yusuf's African ancestry can be documented. According to the Moorish historian Ali ibn Abd Allah, in his *Roudh el-Kartas* (from Beaumier's French translation), Yusuf was "teint brun, taille moyenne, maigre, peu de barbe, voix douce, yeux noirs, nez aquilin, meche de Mohammed retombant sur le bout de l'oreille, sourcils joints l'un a l'autre, cheveux crepus."⁴⁵ ("Brown color, middle height, thin, little beard, soft voice, black eyes, straight nose, lock of Mohammed falling on the top of his ear, eye-brow joined, wooly hair."⁴⁶ *Roudh el-Kartas* was published in 1326, 218 years after Yusuf's death and 132 years after his Almoravid Moors lost control of Spain. But, because Yusuf lived 101 years, it is entirely possible that his exploits and particulars, including race, were vividly remembered for several generations after his death. A review of his exploits clearly illustrates why.

Rogers gives the most complete account in his *World's Great Men of Color*, Vol 1. The Almoravids—which meant "the religious men"—were masters of northwest Africa.⁴⁷ Unlike the Andalusian Moors who had already been in Spain for 300 years, these Almoravids, whose domain was the Sahara, were more war-like by virtue of the terrain on which they lived. Though of the same race and religion as the "Andalusians," the Almoravids were not originally welcomed in Spain. At least, not until they were needed by the "Andalusians." Under the leadership of King Alphonso VI and Rodrigo Diaz de Bivar, better known as "el Cid," the Christians had begun waging battle after battle to reclaim Spain for the cross. According to Dozy,

The idea of calling in the aid of the Almoravides appealed chiefly to the religious[faithful]. The princes, on the other hand, for a long time hesitated. Some of them ... kept up a correspondence with Yusuf ibn Tashifin, King of the Almoravides, and they had more than once gone so far as to seek his aid against the Christians; but the Andalusian princes as a whole had little sympathy with the chief of the barbarous and fanatical warriors of the Sahara, regarding him more as a dangerous rival than an ally. But the daily waxing peril rendered it necessary to grasp the only remaining means of safety. Such at least was Mu'tamid's opinion, when his eldest son, Rashid, pointed out the danger of introducing the Almoravides into Spain, he replied: 'That is true, but I have no desire to be branded by my descendants as the man who delivered Andalusia a prey to the infidels [Christians]; I am loath to have my name cursed in every Moslem pulpit; and for my part, I would rather be a cameldriver in Africa than a swineherd in Castile.' Mu'tamid [of Toledo] encouraged the princes of Badajoz and Granada to join with him in inviting Yusuf to Spain.⁴⁸

Yusuf was invited with the stipulation that he and his men return to Africa after defeating the Christians. Yusuf accepted those terms. According to Rogers, of his 15,000 men, 6,000 were Senegalese, "jet black and of unmixed descent."⁴⁹ The Almoravids routed Alphonso VI's army of 70,000 at Zalacca, in October, 1086.⁵⁰

The Christians assembled another army and, again, Yusuf agreed to defend the Islamic empire. "By 1091 Yusuf had reunited all of Moslem Spain except for Zaragoza and this was recaptured by his successor."⁵¹ Driven both by the euphoria of victory and incensed by the weakness of his Moorish brethren in Spain, Yusuf decided to stay and rule.

Besides conquering Spain, to Yusuf's credit, the Almoravids also conquered Morocco and Algeria. He is said to have founded the city of Marrakesh. Under Yusuf's rule, the Almoravid's empire ran from the Senegal River in West Africa to the Ebro River in Spain, earning the name of the Empire of the

*Editor's Note: The author is using the word "Andalusian" here to refer to the invading Moors rather than the natives of Spain, which the Moors had renamed *Al-Andalus*.

Two Shores.⁵² When their power waned, they were dethroned by the Almohade Moors in 1189.

During the Almohades' prominence on the world stage, they were under the leadership of Yakub Al-Mansur. Al-Mansur was not only a military genius, he was a man of culture. In Beaumier's French translation of historian Ali ibn Abd Allah's text, Yakub Al-Mansur is described as, "Etait fils d'une negresse qui avait ete donnee a son pere, et il naquit dans la maison de son grandpere, Abd el-Moumen, a Maroc, l'an 555."⁵³ ("He was the son of a Negro woman who had been given to his father and he was born in the house of his grandfather, Abd el Mumen.")⁵⁴ Like Yusuf ibn Tashifin, this history, published in 1326, says that Al-Mansur was brown in color⁵⁵ and the historian was recording these facts a mere 127 years after Al-Mansur's death in 1199 A.D.

According to Rogers, Yakub Al-Mansur conquered Spain and Portugal on three separate occasions, while intermittently returning to Africa. His victory in 1189 seems to have been in retaliation for his father's death at the hands of the Christians in Portugal in 1184. Afterward, he returned to Africa to counter an uprising by the Almoravids. At the same time, the Christians assumed that the Almohades could not manage two theatres of war and made an all-out attack on the Moorish empire. Al-Mansur and his legion of African soldiers returned to Spain in 1191 to repeat their earlier conquest, before again returning to Africa. The final conquest came in 1194, when the Almohades defeated an army of 300,000 Christians. In his time, Yakub Al-Mansur was considered the most powerful ruler in the world. He was also a builder of great cities, as well as enduring monuments, such as the Giralda in Seville, which stands even today.⁵⁶

These three notable military geniuses are but a portion of the irrefutable evidence of the significant role that African Muslims played in the conquering and ruling of Spain. But there is other evidence as well. For example, on a mountainside at Granada, there are the words, "Barranco de los Negros" ("Barracks of the Negroes") inscribed on what Rogers terms "tunnelled-out homes."⁵⁷ Then there is the coat of arms of the Almoravids, which shows the heads of four black African kings. According to one account, the heads of these four kings, which were crowned with precious jewels, were decapitated ("separada del tronco su negra cabeza") in battle by the Christian forces of Pedro I in 1086.⁵⁸ Rogers published a painting of Moorish chess players in Spain, complete with a white servant, taken from the thirteenth century manuscript of Alfonso le Sage.⁵⁹ On the same page, Rogers showed two paintings of African Muslims from Morocco, one General Bassa and the second, Prince Mulai Arsheid (Rashid). An illustration of Rashid's brother, Mulai Ismael, who was King of Morocco, appears in Rogers' *World's Great Men of Color*.⁶⁰ While it is true that the kingdoms of these two African Muslim rulers did not include Spain, it demonstrates that after the Moors were

pushed back to Africa, they returned to their ancestral home which was still under the rule of their people.

Also of importance is the painting by the seventeenth century Spanish artist, Diego Velazquez, entitled, "Juan de Pareja." As the painting (now hanging in the Metropolitan Museum of Art in New York) so vividly illustrates, Juan de Pareja—who was a friend of the artist—was an almond-colored African with all of the features typical of his ancestry. This painting was done in 1648, 38 years after the Moors were finally expelled from Spain. It must be kept in mind that by this period, some of the African Muslims in Spain had become Christians. Unlike that which the Christians would subsequently do to the Muslims, the Muslims had tolerated the existence of Christians in Spain, although it was a custom to tax them heavily. Juan de Pareja, having a Spanish name (rather than Arabic) was undoubtedly from a family of one of these African Christians who were permitted to remain in Spain.

African Muslims were not only vital in the conquest and rule of Moorish Spain, but made significant contributions to other parts of the Islamic world. One of the most prolific Islamic writers of the Middle Ages was an African, Al Jahiz wrote several books, including works on zoology. He is best remembered for *Kitab al Sudan wa 'l-Bidan (The Superiority in Glory of the Black Race Over the White)*.⁶¹ Another African Muslim, Nedjeh, and his descendants ruled Arabia from 1020 to 1158 A.D.⁶² And, as noted earlier, *Tarikes-Sudan*, published in 1640 by the African Muslim historian Abderrahman Es-Sadi, is often referred to as the "Bible of the Sudan."

While the contributions of Africans to the Islamic empire from its foundation to the present are too numerous to be considered, one event in particular stands out as a demonstration of the high esteem in which Africans were held. At the height of the Crusades, when the Islamic world was under heavy assault by the Christians, Saladin—the Sultan of Egypt, Palestine and Syria—turned to Yakub Al-Mansur for help.⁶³ As Rogers says, "During the Crusades (1096-1270) so many Negroes were taken out of Ethiopia and the Sudan to fight the white Christian invader that in 1196 Negro troops in Egypt '50,000 strong dominated the court and the armies.' The Marshal of the Palace, a Negro eunuch, the Moutamen Elkhelafe, their protector, was one of the most powerful men in the empire."⁶⁴

Ironically, though the origins of Islam are rooted in the African tradition and the growth of the Islamic empire brought forward by the genius and might of African Muslims, as the twentieth century comes to a close, Islam is associated more with the Semitic Arabs. How did this come about?

The Amalgamation of the Races in North Africa

There appears to be several factors which contributed to the amalgamation of the races of Africans, Semitic Arabs and Europeans with the result of a

large proportion of light-skinned people now inhabiting North Africa. We must not forget, though, that even today, North Africa is still heavily populated by dark-skinned Africans similar to the original inhabitants of the region.

Once the original population was conquered and converted to Islam by armies of African Muslims from the east, the Semitic Arabs easily migrated westward in great numbers, unopposed by virtue of their common Islamic faith. Chancellor Williams says that, "... the poor and hungry nomads from the vast desert areas of the Middle East poured into the most fertile and easily accessible areas of this other land of deserts that is North Africa."⁶⁵ It was the migration of these Semites and the erosion of a once fertile land that is now the Sahara Desert that forced the major portion of the African population towards the interior of the continent. As Williams continues, "For the weaker, more submissive Blacks remained in Asia-occupied [Semitic] territory to become slave laborers and slave soldiers, and to witness a ruthless sexual traffic in Black women that gave rise to a new breed of Afro-Asians ... They themselves bitterly objected to being identified with the race of their mothers — African This 'New Breed,' half-African, was to join with their Asian fathers and forefathers in the wars and enslaving raids against the Blacks that went on century after century until all North Africa was taken."⁶⁶

Also contributing to the 'whitening' of the North African population was the number of whites from Europe brought there as slaves. According to Rogers, each time Yakub Al-Mansur returned to Africa from his campaigns in Europe, he did so with a large number of white slaves.⁶⁷ Rogers also quotes from other sources, one published in 1809 and the other in 1908: "They [the Moors] carry the Christian captives about the Desert to the different markets ..." and "There can be no mistake about the records of history which state that thousands of Christian slaves, many of them British, were sold in the great white market at Salli."⁶⁸ At least one historian says that Europeans sold Europeans into slavery, "to the Muslim princes of North Africa and Spain."⁶⁹

Of course, not all conquered Europeans became slaves. There were Europeans who converted to Islam and some of them rose to high rank in Islamic society:

From 939 on, Abd-er-Rahman III encouraged the establishment of the system of *clientela*. This *clientela* was made up of groups of slaves from the Black Sea region, French, Germans, Lombards, Calabrians and other Europeans who were brought as children and subsequently educated in the Caliph's palace. They became his administrators, functionaries and soldiers, many of the latter attaining rank of General. They were a favored group, loyal to the Caliph personally and because of their power and wealth, they formed an elite corps within Moslem society During the tenth century, their numbers increased, there being at one time 15,000 of them in Cordova.⁷⁰

It was the descendants of these white Muslims, along with the mulatto

children born to intermarriage between the Moorish and Spanish peoples, and the Moors, themselves, who were finally expelled from Spain in 1610. Along with the other aforementioned factors, this contributed greatly to the change in complexion of the people of North Africa.

Conclusion

Though the Moors lost military, political and economic control of Spain, their influence lingered long after their physical departure. Spain and Portugal, more than any other European populations, derived enormous benefits from the Moorish and African Muslim presence. They became, for a while, world leaders in the nautical sciences. And, it was not until 1588 (with the defeat of the Spanish Armada) that the other European nations were able to challenge them and become serious rivals in the game of discovery and colonization.

With Spain and Portugal in the lead, Europe as a whole profited enormously from the Moorish civilization. Jackson quotes a historian as saying that, "None of our modern sophistry redeems the squalor of Europe from the fifth to the eleventh century."⁷¹ Stanley Lane-Poole provides us with a most vivid description of the contrast between Moorish Spain and the backwardness of the other European countries:

Cordova was the wonderful city of the tenth century; the streets were well paved and there were raised sidewalks for pedestrians. At night one could walk for ten miles by the light of lamps, flanked by an uninterrupted extent of buildings. All this was hundreds of years before there was a paved street in Paris or a street lamp in London. Cordova with a population exceeding one million was served by four thousand public markets and five thousand mills. Its public baths numbered into the hundreds, when bathing in the rest of Europe was frowned upon as a diabolical custom, avoided by all good Christians. Moorish monarchs dwelt in sumptuous palaces, while the crowned heads of England, France and Germany lived in big barns, lacking both windows and chimneys and with only a hole in the roof for the exit of smoke. Education was universal in Moslem Spain, being given to the most humble, while in Christian Europe 99 percent of the populace was illiterate, and even kings could neither read nor write. In the tenth and eleventh centuries, public libraries in Christian Europe were conspicuous by their absence, while Moslem Spain could boast of more than seventy, of which the one in Cordova housed 600,000 manuscripts. Christian Europe contained only two universities of any consequence, while in Spain there were seventeen outstanding universities. The finest were those located in Almeria, Cordova, Granada, Jaen, Malaga, Seville, and Toledo. Scientific progress in astronomy, chemistry, physics, mathematics, geography, and philology in Moslem Spain reached a high level of development. Scholars and artists formed associations to promote their particular studies, and scientific congresses were organized to promote research and facilitate the spread of knowledge.⁷²

The legacy of the Moors and the African Muslims to European civilization has been largely ignored, hidden or denied and those who would expose the truth of Europe's indebtedness to the Moors have been overlooked or locked away from mainstream information sources. Yet, even a cursory review of Europe prior to the Moorish presence, provides ample evidence of their stumbling around in disorder and darkness. There can be no doubt that the explorations of new worlds and the scientific, social, political, and even public health and urban developments would not have been possible without their longstanding and fundamental contacts with Moorish civilization.

Notes

1. J.A. Rogers, *Sex and Race*, Vol. 1, 1967, p. 284.
2. D.S. Margoliouth, *Mohammed and the Rise of Islam*, 1927, p. 49.
3. Rogers, *Op. Cit.*, p. 96.
4. Drusilla Dunjee Houston, *Wonderful Ethiopians of the Ancient Cushite Empire*, 1985, p. 113.
5. Cheik Anta Diop, *The African Origin of Civilization*, 1974, p. 127.
6. Houston, *Op. Cit.* p. 23.
7. Josef A.A. ben-Jochannan, *Black Man of the Nile and His Family*, 1981, p. 350.
8. Asa G. Hilliard III, et al, editors, *The Teachings of Ptahhotep: The Oldest Book in the World*, 1987, p. 14.
9. *Ibid.*, p. 17.
10. J.A. Rogers, *World's Great Men of Color*, Vol. I, (first published in 1947) 1972, pp. 185–187.
11. Godfrey Higgins, *Anacalypsis*, Vol. I. (first published 1836) 1972, p. 467.
12. Edward Wilmont Blyden, *Christianity, Islam and the Negro Race*, (first published in 1887) 1967, p. 266.
13. W.E.B. Du Bois, *The World and Africa*, 1987, pp. 185–186.
14. *Ibid.*, p. 223.
15. Blyden, *Op. Cit.*, p. 264.
16. Rogers, *World's Great Men of Color*, Vol. 1, pp. 139–140.
17. Du Bois, *Op. Cit.*, p. 223.
18. Blyden, *Op. Cit.*, p. 264.
19. Burchard Brentjst, *Die Mauren: Der islam in Nordafrika und Spanien (642–1800)*, 1989, figures 2 and 4.
20. *Ibid.*, figure 21.
21. Wayne B. Chandler, "Hannibal: Nemesis of Rome," *Great Black Leaders: Ancient and Modern*, editor, Ivan Van Sertima, 1988, p. 284.
22. J.C. deGraft-Johnson, *African Glory*, 1986, p. 59.
23. *Ibid.*
24. Blyden, *Op. Cit.*, p. 266.
25. J. Desanges, "The Proto-Berbers," *General History of Africa*, Vol. 2, editor, G. Mohktar, 1981, p. 423.
26. deGraft-Johnson, *Op. Cit.*, p. 55.
27. J.A. Rogers, *Nature Knows No Color-Line*, 1952, p. 55.
28. Reinhart Dozy, *Spanish Islam*, 1972, p. 125.
29. Rogers, *World's Great Men of Color*, Vol. 1, p. 110.
30. Thomas Arnold and Alfred Guillaume, *The Legacy of Spain*, p. 5.

31. Dozy, *Op. Cit.*, p. 139.
32. DuBois, *Op. Cit.*, p. 192.
33. Rogers, *Nature Knows No Color-Line*, p. 55.
34. Du Bois, *Op. Cit.*, p. 183.
35. Rogers, *Nature Knows No Color-Line*, p. 55 and *Sex and Race*, Vol. 1, p. 151.
36. DuBois, *Op. Cit.*, p. 183.
37. deGraft-Johnson, *Op. Cit.*, pp. 68, 70, 71, 89, 123.
38. Arnold and Guillaume, *Op. Cit.*, p. 5.
39. Dozy, *Op. Cit.*, pp. 125 and 139.
40. deGraft-Johnson, *Op. Cit.*, pp. 68–69.
41. John G. Jackson, *Man, God and Civilization*, 1972, p. 271.
42. Dozy, *Op. Cit.*, p. 233.
43. Thomas W. Arnold, *The Preaching of Islam*, 1986, p. 132.
44. Rogers, *Nature Knows No Color-Line*, p. 69.
45. Ali ibn Abd Allah, *Roudh el-Kartas*, French translation by F. Beaumier), 1860, p. 190.
46. Rogers, *World's Great Men of Color*, Vol. 1, p. 223.
47. Lee Anne Burham Seminario, *The History of the Black, the Jews and the Moors in Spain*, 1975, p. 86.
48. Dozy, *Op. Cit.*, pp. 694–695.
49. Rogers, *World's Great Men of Color*, Vol. 1, p. 219.
50. *Ibid.*
51. Seminario, *Op. Cit.*, pp. 86–87.
52. deGraft-Johnson, *Op. Cit.*, p. 88.
53. Ali ibn Abd Allah, *Roudh el-Kartas*, p. 304.
54. Rogers, *World's Great Men of Color*, Vol. 1, p. 225.
55. Ali Ibn Abd Allah, *Op. Cit.*, p. 304.
56. Rogers, *World's Great Men of Color*, Vol. 1, pp. 225–229.
57. Rogers, *Sex and Race*, p. 152.
58. Manuel Hernandez, *Comentarios de las Cosas de Aragon*, 1878, p. 110.
59. Rogers, *Nature Knows No Color-Line*, p. 64.
60. Rogers, *World's Great Men of Color*, Vol. 1, p. 256.
61. Rogers, *Sex and Race*, Vol. 1, p. 97.
62. Du Bois, *The World and Africa*, p. 195.
63. Rogers, *World's Great Men of Color*, Vol. 1, p. 229.
64. Rogers, *Nature Knows No Color-Line*, p. 58.
65. Chancellor Williams, *The Destruction of Black Civilization*, 1987, p. 50.
66. *Ibid.*, pp. 50–51.
67. Rogers, *World's Great Men of Color*, Vol. 1, pp. 225–229.
68. Rogers, *Sex and Race*, pp. 111–112.
69. Basil Davidson, *The Story of Africa*, 1984, pp. 105–106.
70. Seminario, *The History of the Blacks, the Jews and the Moors in Spain*, p. 81.
71. Jackson, *Op. Cit.*, p. 261.
72. *Ibid.*, pp. 272–273.

Bibliography

- Abd Allah, Ali ibn, *Roudh el-Kartas*, (French translation by F. Beaumier), Paris, A L'Imprimerie Imperiale, 1860 (first published 1326)
- Arnold, Thomas and Guillaume, Alfred, *The Legacy of Spain*, London, Oxford University Press, 1965

- Arnold, Thomas W., *The Preaching of Islam: A History of the Propagation of the Muslim Faith*, London, Darf Publishers Ltd., 1986
- ben-Jochannan, Yosef A. A., *Black Man of the Nile and His Family*, New York, Alkebulan Books and Education Materials Association, 1981
- Blyden, Edward W., *Christianity, Islam and the Negro Race*, Edinburgh, University of Edinburgh Press, 1967 (first published 1887)
- Bovill, E. W., *The Golden Trade of the Moors*, London, Oxford University Press, 1958
- Brentjes, Burchard, *Die Mauren: Der Islam in Nordafrika und Spanien (642-1800)*, German Democratic Republic, Herold, 1989
- Chandler, Wayne B., "Hannibal: Nemesis of Rome," *Great Black Leaders: Ancient and Modern*, editor, Ivan Van Sertima, New Brunswick, N.J., Transaction Books, 1988
- Davidson, Basil, *The Story of Africa*, London, Mitchell Beazley Publishers, 1984
- deGraft-Johnson, J. C., *African Glory*, Baltimore, Black Classic Press, 1986 (first published 1954)
- Desanges, J., "The Proto-Berbers," *General History of Africa, Vol. 2: Ancient Civilizations of Africa*, Berkeley, Calif., Heinemann-California-UNESCO, 1981
- Diop, Cheikh Anta, *The African Origin of Civilization*, Westport, Conn., 1974
- Dozy, Reinhart, *Spanish Islam*, London, Frank Cass, 1972
- DuBois, W. E. B., *The World and Africa*, New York, International, 1987
- Gallego, Julian, *Zurbara, 1598-1664*, New York, Rizzoli, 1977
- Graves, Anna Melissa, *Africa: The Wonder and the Glory*, Baltimore, Black Classic Press, 1984 (?) (first published 1942)
- Hernandez, Manuel, *Comentarios de las Cosas de Aragon (Biblioteca de Escritores Aragoneses)*, Zaragoza, Spain, Imprenta del Hospicio, 1878
- Higgins, Godfrey, *Anacalypsis: An Inquiry into the Origin of Languages, Nations and Religions Vol. 1*, London, Longman, 1836
- Hilliard III, Asa G., et al, editors, *The Teachings of Ptahhotep: The Oldest Book in the World*, Atlanta, 1987
- Houston, Drusilla Dunjee, *Wonderful Ethiopians of the Ancient Cushite Empire*, Baltimore, Black Classic Press, 1985 (first published 1926)
- Jackson, John G., *Man, God and Civilization*, Secaucus, N.J., Citadel Press, 1972
- Jackson, John G., *Ethiopia and the Origin of Civilization*, Baltimore, Black Classic Press, 1984 (?) (first published 1939)
- James, George, G. M., *Stolen Legacy*, San Francisco, Julian Richardson Associates, 1976 (first published 1954)
- Lane-Poole, Stanley, *The Story of the Moors in Spain*, New York, G. P. Putnam's Sons, 1886
- Margoliouth, D. S., *Mohammed and the Rise of Islam*, London, G. P. Putnam's Sons, 1927
- McCabe, Joseph, *The Splendour of Moorish Spain*, London, Watts & Co., 1935
- Parker, George Wells, *The Children of the Sun*, Baltimore, Black Classic Press, 1981 (first published 1918)
- Robinson, James Harvey and Breasted, James Henry, et al, *Earlier Ages: History of Civilization*, New York, Ginn and Company, 1960
- Rogers, J. A., *Nature Knows No Color-Line*, St. Petersburg, Fla., Helga M. Rogers Publisher, 1952
- Rogers, J. A., *Sex and Race Vol. 1*, St. Petersburg, Fla., Helga M. Rogers Publisher, 1967 (first published 1952)
- Rogers, J. A., *World's Great Men of Color Vol. 1*, New York, Collier Books, 1972, (first published 1946)

- Seminario, Lee Anne Durham, *The History of the Blacks, the Jews and the Moors in Spain*, Madrid, Plaza Manor, 1975
- Thomas, Bertram, *The Arabs*, Garden City, N.J., Doubleday, 1937
- Williams, Chancellor, *The Destruction of Black Civilization: Great Issues of a Race from 4500 B.C. to 2000 A.D.*, Chicago, Third World Press, 1987

CAIRO: SCIENCE ACADEMY OF THE MIDDLE AGES

Beatrice Lumpkin and Siham Zitzler

Summary *In the Middle Ages, Egypt and North Africa continued their tradition of leadership in science and mathematics, a tradition then already 4,000 years old. At Cairo, a Science Academy was established, similar to the Science Academy of Baghdad. From North Africa, the most advanced mathematics, science, medicine and literature were introduced to less developed Europe. The later flowering of science and culture in Europe known as "the Renaissance," was a direct result of this African gift of knowledge, combined, of course, with internal economic and social developments in Europe itself. This huge intellectual debt to Africa and Asia has never been acknowledged by Western historians. On the contrary, most European historians (and North Americans) have denied that Muslim scholars created anything new, merely crediting them with preserving Greek (European) learning during the Middle Ages.*

The Cairo Academy

Dar-el-Hikma, the House of Wisdom, was built in Cairo in 1005 with a grant by the Fatimid caliphs who ruled North Africa. A true science academy, the Cairo House of Wisdom provided a center where high-level mathematicians and scientists could work and consult. Many great contributions to world knowledge came from this Science Academy. It was at the well-equipped observatory of the Dar-el-Hikma that Ibn Yunus, "perhaps the greatest Muslim astronomer," in the judgment of Sarton,¹ completed the famous Hakimi tables and where Ibn Haytham (Alhazen) enriched physics, mathematics, astronomy and medicine.

Soon, the Cairo House of Wisdom became known in every field of study. Yushkevitch, the Soviet authority on the Muslim mathematicians, describes this period of rapid scientific advancement which included, but went beyond, mathematics:

In this same period, chemistry, medicine, pharmacology, zoology, botany, and mineralogy knew an extraordinary development. . . like Aristotle, the thinkers of the Islamic world were distinguished by their interest in every field of knowledge, their encyclopedic knowledge and by their very varied research. For example, the mathematicians were often involved in medicine.²

In Cairo and other North African locations, notably Tunis, a happy union of scientific tradition, efficient centralized government and a rich economic base supported peaceful, sustained research and attracted scholars from other parts of the Muslim world. The Fatimid caliphs were great patrons of science and learning. As always, science advanced when government supplied the necessary material and moral support.

The African scientists, through the use of Arabic as the common language of learning, were able to communicate with their colleagues over the vast stretches of Muslim influence, from Spain and Italy on the West across Africa and Asia, to China on the East. This was also a period of expanded trade. Muslim traders pushed energetically into every known corner of the world, increasing their wealth, and more importantly, spreading knowledge of the new Muslim mathematics and science. The convenient Arabic numerals and arithmetic, which we use today, were adapted from India and brought into Europe by the Moors of North Africa. Speaking of the Moors, Smith and Karpinski write:

"The Arabs dominated the Mediterranean sea long before Venice, and long before Genoa had become her powerful rival."³

Advance of Technology

The rapid progress of technology in this period also stimulated the development of science. For example, windmills were invented at this time and were first described in 947 by Al-Mas'udi, an Arab writer who lived in Egypt.⁴ *The Book of Ingenious Devices*, published in the 9th century by the brothers, Banu Musa bin Shakir, shows the high level of Muslim technology (see Figure 1). The Banu

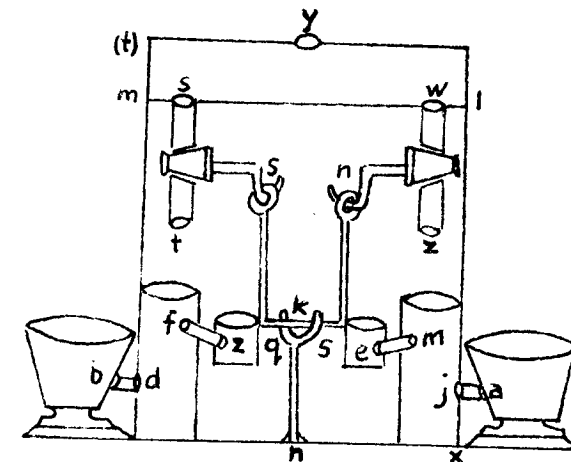

Fig. 1. Drawings from Banu Musa's *The Book of Ingenious Devices*. (Illustrator: Sylvia Bakos)

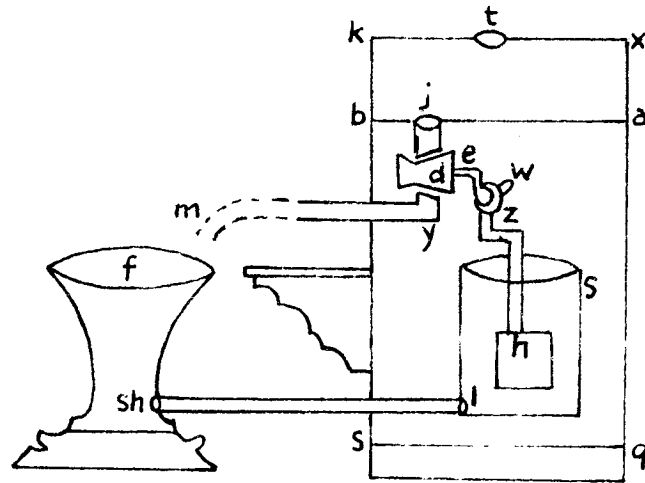

Fig. 1. (cont.)

Musa employed self-operating valves, timing mechanisms and delays, and worm and pinion gears, mainly operated hydraulically. Automatically operated cranks, shown in several of their drawings, are essentially crankshafts, in the opinion of Gordon Deboo of NASA.⁵

The universality of the science of the Muslim period resulted from a blend of theory and practice which stimulated the growth of new ideas. Insistence on rigorous proof in mathematics, as introduced during the Hellenistic period in Egypt, was maintained, alongside of respect for technology. Outstanding instrument makers were acclaimed as great men of science. Even before the Muslim period, Egypt was noted for her advanced technology. The first steam engine was built by Heron in Alexandria (ca. 100). The first water clock, a thermometer, and other gadgets were also developed in the Egypt of the earlier period.⁶

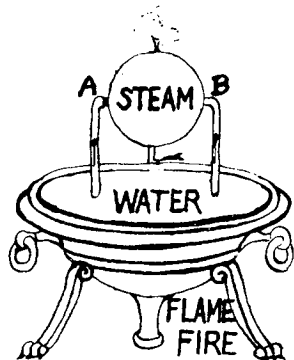

Fig. 2. Heron's engine—the first steam engine. Steam from the boiling water rises through the vertical pipes and enters the spherical steam chamber at A and B. A and B serve as pivot points about which the chamber revolves, driven by the reaction from the steam escaping through the two small nozzles. The design of this famous engine, which undoubtedly served as the inspiration for engines built during the Industrial Revolution in Europe centuries later, is still used today in physics lecture demonstrations and other applications. (Illustrator: Sylvia Bakos)

The famous steel for the superb swords of Damascus was made in only three locations; one was in Egypt. According to Al-Kindi, a medieval Muslim historian and philosopher, swords forged in Egypt were made from “manufactured” iron, i.e. steel.⁷ The noted traveler-historian, Ibn Battuta, described the shipment of iron from the mines of Lebanon, where the iron was loaded on ships at Beirut for sale in Egypt.⁸

يُجْعَلُ فِي كُلِّ بَوَاطِقَةٍ حَسَّةٌ أَرْطَالٌ مِنْ نَعَالِ الدَّوَابِّ وَمَسَامِيرُهَا الْمَعْمُولَةُ مِنَ الزَّمَانِ وَمِنْ كُلِّ وَاحِدٍ مِنَ الدَّوَابِّ سِتِّينَ وَالْمَرْقَشِيَّةِ الذَّهَبِيِّ وَالْمَعْيِيسِيَّةِ الْخَشَّةِ وَزَنْ عَشْرَةَ دَرَاهِمٍ وَيَطْبَعُ الْبَوَاطِقَ وَتَوَدَّعَ الْكُورَ وَتَمَلَأُ فَحْماً وَيَنْفِخُ عَلَيْهَا بِالْمَنَافِخِ الرُّومِيَّةِ كُلِّ مَنَافِخٍ بَرَجَانِ إِلَى أَنْ تَنْوَبَ وَتَدْوَرُ وَقَدْ أَعْدَلَهُ صَرراً فِيهَا أَهْلِيئِجٌ وَقَشْرَ رَمَانٍ وَمَلِجٌ الْعَجِينِ وَأَصْدَافَ اللَّوْلُوِّ بِالسُّوِيَّةِ مَجْرَشَةَ فِي كُلِّ حُرَّةٍ أَرْبَعِينَ دِينَاراً يُلْقَى فِي كُلِّ بَوَاطِقَةٍ وَاحِدَةً ثُمَّ يَنْفِخُ عَلَيْهِ سَاعَةً نَفْحاً شَدِيداً رَحْمَةً ثُمَّ تَبْرُكُ حَتَّى تَبْرُدَ وَتَخْرُجَ الْبَيْضَاتُ عَنْ بَوَاطِقِ .

Fig. 3. Script of Al-Kindi, describing the manufacture of steel in the 12th century.

Medieval Europe Far Behind

In this same period of Muslim pre-eminence in every field of learning, Europe was so far behind that George Sarton, encyclopedist of sciences, in a comparison of European with Muslim learning, wrote:

“Let us pass to Islam. It is almost like passing from the shade to the open sun and from a sleepy world into one tremendously active.”⁹ Further, Sarton added, “The overwhelming superiority of Muslim culture continued to be felt throughout the tenth century.”¹⁰

African Mathematicians

Perhaps it was in the mathematical sciences of mathematics, physics, and astronomy, that the influence of the Cairo Academy of Sciences was felt most strongly. The very word algebra is an Arabic word, adopted in Europe to describe some of the new mathematics that the Moors had brought into Europe. The word for algorithm, a mathematical procedure, is a corruption of the name of Al-Khwarizmi, the Persian author of the algebra textbook that took Europe by storm.

In Egypt, the algebra of Al-Khwarizmi was developed to a higher level by Abu Kamil (850-930). Abu Kamil's full name translates as the Egyptian Calculator (Abu Kamil ibn Aslam ibn Muhammad ibn Shuja al-hasib al Misri). The *Algebra* of Abu Kamil was a very popular book, the most advanced of its time. Whereas Al Khwarizmi dealt with one unknown, Abu Kamil used several. Especially noteworthy was his work with complex irrational quantities, displaying,

according to Yushkevitch, "a remarkable facility for operations on extremely complex irrationals of the 2nd degree."¹¹

The work of Abu Kamil was known to Leonardo Fibonacci of Pisa who based his research on Abu Kamil's *Algebra*. From the 21 problems of Abu Kamil's *On the Pentagon and Decagon*, Leonardo copied 17, even using the same number facts.¹²

A characteristic of Abu Kamil's treatment of algebra was the high theoretical level of his work. He was among the Muslim mathematicians who not only used irrational numbers but also made them the object of theoretical studies. They started their investigation with the theory of proportions from the Hellenistic period. After a critical analysis of the old theory, they developed their own theory, extending the notion of number to the set of all real positive numbers. This remarkable theoretical achievement reached Europe centuries later, towards the end of the 16 century.¹³

Abu Kamil's work showed progress beyond the purely geometric basis of mathematics. He operated on lengths and areas alike as pure numbers. A few examples will serve to illustrate his work:

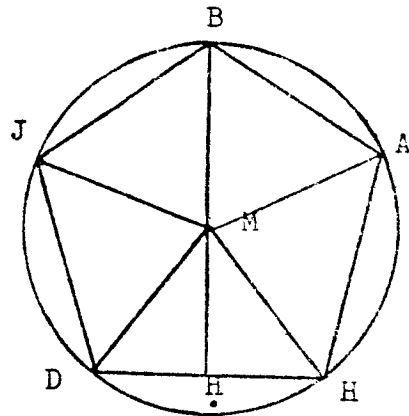

$$\frac{\sqrt{2x^2+2x^2}}{\sqrt{5}}$$

Fig. 4. Reproduced from Abu Kamil's "The Pentagon and the Decagon". Given the side of a regular pentagon, find the diameter.

In *The Pentagon and the Decagon*, Example XVI, Abu Kamil refers to a circumscribed, regular pentagon whose side is 10, as though he were solving only one specific problem (see Figure 4). But he immediately generalized: "It is obvious that you multiply one of its sides by itself; then you double it and keep it. Then multiply again, one of its sides by itself, then the result by itself. Then take

4/5 of it whose square root you find, then add the results to what you kept, then take the square root of the sum. What is left is the diameter of the circle."¹⁴

Or, in the shorter language of modern mathematics, the diameter of the circle which circumscribes a regular pentagon of side x is:

$$\frac{\sqrt{2x^2+2x^2}}{\sqrt{5}}$$

In his *Algebra*, Abu Kamil developed the following useful formula, illustrating with simple examples:

$$\begin{aligned} \sqrt{a} \pm \sqrt{b} &= \sqrt{a+b \pm 2\sqrt{ab}} \\ \sqrt{18} \pm \sqrt{8} &= \sqrt{18+8 \pm 2\sqrt{144}} \\ \sqrt{10} \pm \sqrt{2} &= \sqrt{10+2 \pm 2\sqrt{20}} \end{aligned}$$

The method of false position, first used by the ancient Egyptians to solve equations, was further applied by this Egyptian of the Middle Ages to solve non-linear systems of 3 equations involving solutions of some 4th degree equations. Abu Kamil also investigated indeterminate equations and found 2,676 solutions for this system:¹⁵

$$\begin{aligned} x+y+z+u+v &= 100 \\ 2x+\frac{y}{2}+\frac{z}{3}+\frac{u}{4}+v &= 100 \end{aligned}$$

Ibn Yunus

Two of the most famous mathematical scientists at the Cairo House of Wisdom were Ibn Yunus and Ibn al-Haytham. Ibn Yunus (died Cairo 1009) was one of the great astronomers of all time. He prepared the Hakimi Tables (al-Zidj al-kabir al-Hakimi) which contained observations of eclipses and conjunctions of the planets. The tables were named in honor of the Fatimid caliph, Al-Hakim, patron of the Cairo House of Wisdom. Ibn Yunus' purpose was to test and improve the observations of earlier astronomers and their measurements of astronomical constants with the aid of the superior equipment of the Science Academy observatory on the Mukkatam range. He solved difficult problems of spherical astronomy with the aid of orthogonal projections of the celestial sphere on the horizon and the plane of the meridian.¹⁶

In those days there were no logarithms to shorten the many tedious calcula-

tions of astronomy. *The Mathematics Teacher*, in its October 1977 issue, featured an article titled "Sixteenth Century Astronomers had Prosthaphaeresis."¹⁷ The article referred to the trigonometric formula which had been discovered by Ibn Yunus, over 500 years earlier, in Africa! Ibn Yunus used his formula to change multiplications to the easier addition-substraction operations:

$$\cos A \cos B = \frac{1}{2} \cos(A+B) + \frac{1}{2} \cos(A-B)$$

Yushkevitch notes that this identity was used by the noted Danish astronomer, Tycho Brahe, and other Europeans half a millenium later.¹⁸ Ibn Yunus improved on the tables of Ptolemy, a much earlier Egyptian astronomer, coming within 10 millionths of the true value of $\sin 1^\circ$

Ibn al-Haytham

Abu Ali al-Hasan ibn al-Hasan ibn al-Haytham, one of the greatest physicists in the history of science, also worked at the House of Wisdom in Cairo (died Cairo c. 1039). In Europe, he is known by the name of Alhazen. He was also a mathematician, astronomer, physicist and physician. His book on *Optics*, (*Kitab al-Manazir*), which contains important discoveries on the physiology of vision and the theory of reflection and refraction of light, had a great influence on the development of optics in medieval Europe. So advanced was his work that its translation into Latin and publication in Europe, over 500 years after his death, had a great influence on Roger Bacon and Johann Kepler.¹⁹

Ibn al-Haytham posed and solved the problem which became known in Europe as Alhazen's problem (see Figure 5).

Given a fixed position of an observer's eye and a light source, determine the point on a cylindrical mirror where a light ray would be reflected from the source into the eye. This problem reduces mathematically to: In a plane, given a circle and two points, A and B, outside the circle, find a point C on the circumference such that the straight lines joining point C to the two given points A and B make equal angles with the radius to C.

This problem leads to a 4th degree equation, solved by Ibn al-Haytham using a circle and hyperbola. In the 17th century, Christian Huygens and Isaac Barrow and other scientists became interested in Alhazen's problem.²⁰

One of the precursors of calculus, Ibn al-Haytham was the first to obtain a formula for the 4th powers of the first n natural numbers. He used the formula to evaluate the volume of solids of revolution generated by revolving a parabola around its axis or around a line parallel to the axis. This is equivalent to the

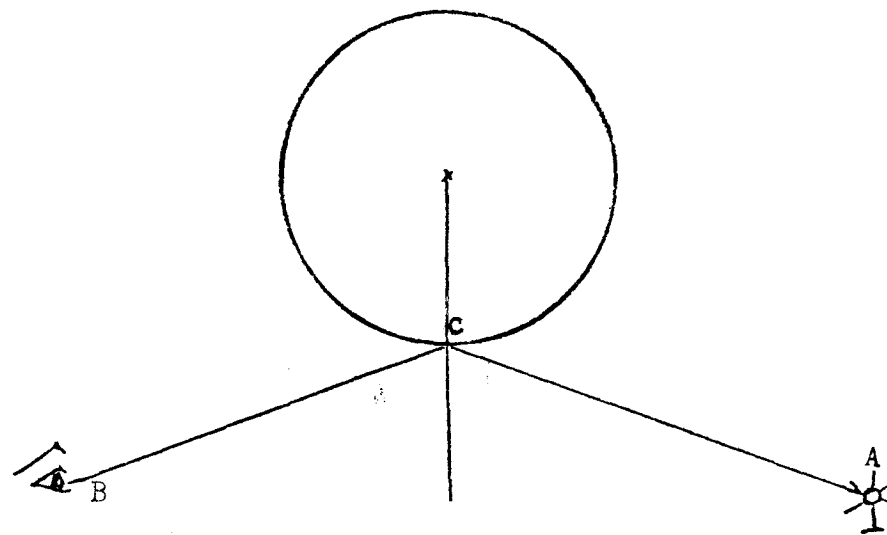

Fig. 5. The famous problem of Alhazen (Ibn al-Haytham). Given a light source at A and observer at B, find point C on a cylindrical mirror such that the light ray will be reflected to the observer at B.

evaluation of the definite integral $\int_0^a t^4 dt$. This result was not known in the earlier Greek period and was not rediscovered in Europe until the 17th century, 600 years after Ibn al-Haytham. Very few calculus students in the United States or Europe are aware that one of the founders of this very important branch of mathematics was a Muslim mathematician at the House of Wisdom in Cairo almost 1000 years ago.

Ibn al-Haytham also helped lay the groundwork for the modern non-Euclidean geometries. Like many mathematicians both before and after him, he tried to prove the independence of Euclid's fifth postulate. He constructed a quadrilateral with three known right angles and investigated the fourth angle, a method utilized by J.H. Lambert in the 18th century, 700 years later. Ibn al-Haytham states, as obvious, a proposition about perpendicular and oblique lines. In 1882, 850 years later, this proposition was stated as an important axiom by Moritz Pasch, an "order" axiom, in the terminology of Hilbert.²²

The outstanding African scholars described above are but a few of many of that fruitful period of history. The Muslim scholars were of different religions, Christians and Jews as well as Muslims. Their unity was one of shared tradition and language, not religion. In this sense they continued the unbroken tradition of 4,000 years of mathematical and scientific development in Egypt. The language changed but the work continued.²³ Regardless of religion, the scholars of that time wrote in Arabic and were steeped in the culture of the Muslim world.

Among African-Jewish scholars of that time, the spirit of scientific inquiry

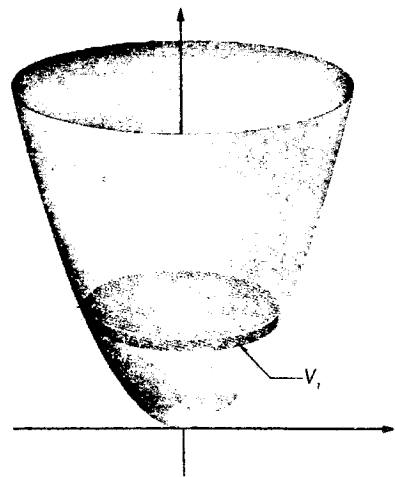

Fig. 6. Volume of a Solid of Revolution generated by revolving a parabola around its axis. Ibn-al-Haytham was first to calculate this volume, now a standard problem in integral calculus.

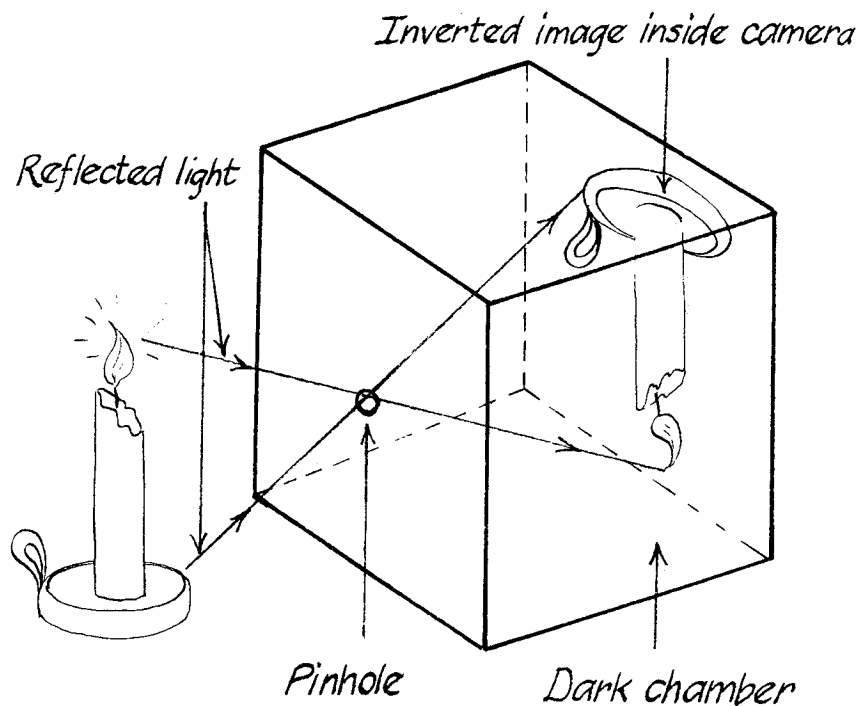

Fig. 7. Camera Obscura principle, illustrated here, was used by Ibn al-Haytham to view the image of the sun during an eclipse. He made extensive use of the experimental method of science. (Illustrator: Sylvia Bakos)

flourished and they participated in the growth of Muslim science. Mashallah, an Egyptian Jewish astronomer who died c. 815, worked in that tradition. He, and a Persian colleague, made the measurements for the plan of the new city of Baghdad.²⁴ A co-religionist of Mashallah in North Africa, Judah ibn Qarish, wrote a dictionary of Semitic languages. Isaac Judaeus (Abu Ya'qub Ishaq ibn Sulaiman el-Isra'ili) an Egyptian Jew who also wrote in Arabic, was the physician to the caliph in Tunis. Among his medical writings are descriptions of fevers, lists of medicinal drugs and treatises on nutrition, urine and ethics.²⁵ To make the Muslim learning more accessible to those who knew only Hebrew, two African Jews from Fez Morocco, David ben Abraham (Abu Sulaiman Da'ud al-Fasi) and Judah ben David (Abu Zakariya Yahya ibn Da'ud) compiled Arabic-Hebrew dictionaries.

Muslim Medicine

It may have been in medicine that Muslim learning made its greatest initial impact on other parts of the world. An Egyptian physician, who greatly influenced European medicine, was the surgeon, Abu-l-Qasim. He wrote a medical encyclopedia of 30 sections, stressing the importance of cauterization. The encyclopedia included views of surgical instruments, far more advanced than any then in Europe.²⁶ Ahmad ibn Muhammad ibn Yahya al-Baladi, another Egyptian doctor, wrote on hygiene for pregnant women and babies. In Tunis, Abu-Ja'far Ahmad ibn Ibrahim ibn al-Khalid ibn al-Jazzar (died 1009) wrote a remarkable description of smallpox, measles, the common cold and the causes of plague in Egypt. Although the medical works of Sa'id ibn al-Batriq (died 939 in Alexandria) have been lost over the years, a copy of his authoritative catalog of jewels, "Jewels Arranged in Order," has survived.

Muslim Spain—Africa in Europe

The great works of scientists and mathematicians of North Africa in the Middle Ages lay the basis for the later flowering of mathematics and science in Europe. But in the case of Iberia the infusion of African learning was immediate following the Moorish conquest in the 8th century.²⁷ In Cordoba, the caliph Al-Hakam II appropriated money to collect a library of 400,000 volumes of the finest works in the Islamic world. The catalog of these books alone took up 44 volumes! Although Cordoba fell in 1236 to the Christians, the science and philosophy, the mathematics and the technology, the music and literature, all of these remained as permanent African contributions to Iberia and the rest of Europe.

One of the greatest Iberian Muslim scholars was Ibn Rusd (1126-90) known in Europe as Averroes. Even in so modern a subject as mathematical logic, which

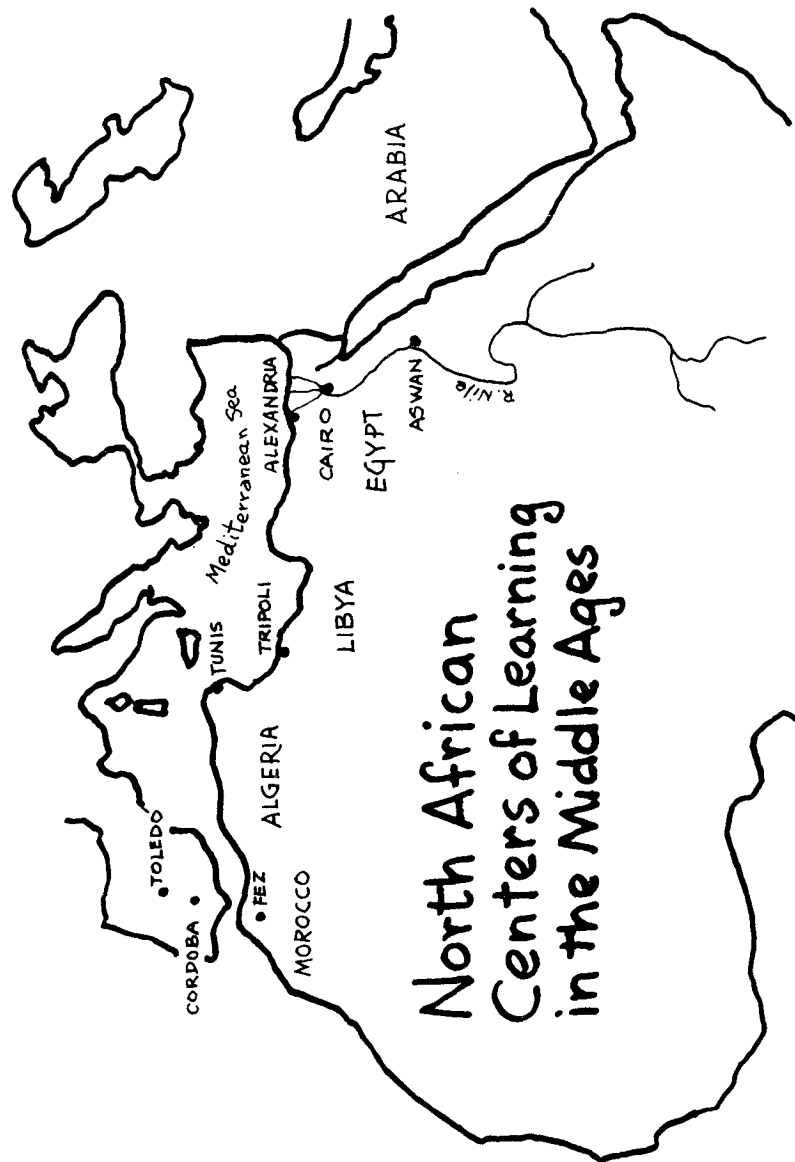

Fig. 8. North African Centers of Learning in the Middle Ages.

had its main development in the 19th and 20th centuries, the foundation was laid by the Muslim mathematicians and philosophers. Albert the Great of Swabia was strongly influenced by ibn Rusd and based his theory of abstractions on the work of ibn Sina (Avicenna).²⁸ Styazhkin, a historian of logic, concludes: "While the Scholastics were able to draw the idea of formal implication from Aristotle, for the elements of the theory of material implication they turned to the works of the Arabian logicians Avicenna, al-Farabi, al-Ghazzali (Algazel) and Averroes."²⁹

One of the first of the new crop of European mathematicians who tried to end European isolation from the mainstream of mathematics was Fibonacci, known also as Leonardo of Pisa. Carruccio quotes from Leonardo's *Liber Abbaci*, written in 1202 after his extensive travels in Algeria and the Mid East. "All that was studied in Egypt, in Syria, in Greece, in Sicily and in Provence . . . with various methods belonging to those places, where I wandered as a merchant, I investigated very carefully and . . . having very accurately studied the way of the Hindi (algebra), instructed by my own enquiries, and adding what I was able to take from Euclid, I wanted to write a work of fifteen chapters, with nothing capital left without a demonstration; and this I did, so that the science might be easily understood, and the Latin people should no longer be deprived of it."³⁰

Indeed, all the European locations mentioned by Fibonacci, had been under Muslim influence, and were major conduits of Muslim learning into Europe. In 827 African Muslims occupied Palermo, then Messina in 842 and Siracuse in 878, where they ruled until 1060. Muslim influence continued in Sicily, after the political domination of the Moors ended, especially under the rule of Federigo II, a patron of learning.

Constantine the African

Mieli tells the story of Constantine, an African merchant who made a trading trip to Salerno, in Southern Italy. Constantine must have seen a great opportunity in Salerno because on his return to Africa he studied medicine for several years. Then Constantine went back to Salerno with a collection of Arabic medical books. Legend has it that he lost some books in a storm at sea but enough were saved to make the medical school of Salerno famous throughout Europe. Constantine translated the Arabic books, adding his own comments. This store of African medical knowledge revolutionized European medicine, "giving a forward thrust to all the other medical schools of Europe."³¹

The Crusades were another means by which Europeans became aware of Muslim learning. Despite the horrible massacres they committed against the Muslims, the more intelligent Crusaders, according to Mieli, recognized that they were in contact with a civilization far superior to their own and tried to become acquainted with Arab literature."³²

In these few pages, only a brief account of the achievements of African mathematicians and scientists of the Middle Ages is possible. But, even in out-

line form, we can see the richness of the body of knowledge developed in Africa and Asia, knowledge essential for the later European Renaissance. Why then do writers like Morris Kline³³ and most Western historians of mathematics repeat, ad nauseam, that true mathematics developed only in Europe? Why do they write that the Muslims merely preserved Greek learning and added nothing new? Or if some historians could not deny the Muslim achievements, why do they claim that the Moorish scholars were really Latin and not African?

For the political reasons behind the revision of history to exclude the true role of African scholars, I refer the reader to my article on "The History of Mathematics in the Age of Imperialism."³⁴ Those guilty of twisting the history of mathematics to fit a pre-conceived colonial mold are sometimes unaware of the startling contradictions that appear in their work. For example, J.F. Scott, on page 61 of his *History of Mathematics* acknowledges that the Arabs, "... did more than preserve; they made some significant contributions of their own." But two pages later, Scott forgets his own honest estimate and slips into the more standard prejudiced judgment:

"The debt which the west owes to the Arabs for their part in preserving and transmitting Greek science is very great. It must not be forgotten, however, that preservation is one thing; creation is something different. Mathematics for its development requires the creative faculty, and there is little evidence of this in the many centuries which separate the decline of Alexandrian science and its revival in the West."³⁵

A more objective estimate, by Carl Boyer, concludes: "It is sometimes held that the Arabs had done little more than to put Greek science into cold storage until Europe was ready to accept it. But the account in this chapter has shown that at least in the case of mathematics the tradition handed over to the Latin world in the 12th and 13th centuries was richer than that with which the unlettered Arabic conquerors had come into contact in the 7th century."³⁶

A similar opinion is expressed by A.P. Yushkevitch, the Soviet author of one of the very few books written about Muslim mathematicians in this century.

"The Islamic mathematicians exercised a prolific influence on the development of science in Europe, enriched as much by their own discoveries as those they had inherited from the Greeks, the Indians, the Syrians, the Babylonians, etc."³⁷

It is time that we remembered the debt owed by our modern science and technology to the great mathematicians and scientists of the Cairo House of Wisdom, Dar-el-Hikma, of almost a thousand years ago.

References

1. George Sarton, Introduction to the History of Science, V. 1, Carnegie Institution, Baltimore, 1927, p 716
2. Adolf P. Youschkevitch (Yushkevitch), *Les Mathematiques Arabes*, (8th-15th centuries)

translated from Russian to French, Vrin, Paris, 1976, p 5. (translations quoted from French to English are mine. B. Lumpkin)

3. David Eugene Smith and Louis Charles Karpinski, *The Hindu Arab Numerals*, Ginn, Boston, 1911, p 106
4. Sarton, op. cit., p 638
5. Gordon Deboo, "The Book of Ingenious Devices," *Arab Perspectives*, Sept. 1981, p 53
6. Carl Boyer, *A History of Mathematics*, Wiley, N.Y., 1968, p 193
7. A.Y. Al-Hassan, "Iron and Steel Technology in Medieval Arabic Sources," *Journal for the History of Arab Science*, Aleppo, Syria, 1978, p 35
8. *ibid*, p 42
9. Sarton, op. cit., p 695
10. *ibid*, p 619
11. Yushkevitch, op. cit., pp 52-61, 81
12. Mohammad Yadegari and Martin Levey, *Abu Kamil's "On the Pentagon and Decagon"* History of Science Society of Japan, Supplement 2, Tokyo, 1971, p 1
13. Yushkevitch, op. cit., p 89
14. Yadegari, op. cit., p 28
15. Yushkevitch, op. cit., pp 56, 66
16. *Encyclopedia of Islam*, V. 2, 1926, p 499
17. R.C. Pierce, Jr., "Sixteenth Century Astronomers Had Prosthaphaeresis" *The Mathematics Teacher*, October 1977, p 613-4
18. Yushkevitch, op. cit., p 136
19. Sarton, op. cit., p 721
20. Yushkevitch, op. cit., p 91-2
21. *ibid*, p 129-30
22. *ibid*, p 116
23. Beatrice Lumpkin, "Africa in the Mainstream of Mathematics," *Journal of African Civilizations*, V. 2, No. 1 & 2 combined, p 73
24. Sarton, op. cit., p 521
25. *ibid*, p 634
26. *ibid*, p 616
27. Yushkevitch, op. cit., p 12
28. N.I. Styazhkin, *History of Mathematical Logic from Leibniz to Peano*. M.I.T. Cambridge, 1969, (orig. Nauka, Moscow, 1964) p 8
29. *ibid*, p 21
30. Ettore Carruccio, *Mathematics and Logic in History and Contemporary Thought*, tr. by Isabel Quigley, Aldine, Chicago, 1964, p 159
31. Aldo Mieli, *La Science Arabe*, E.J. Brill, Leiden, 1938, p 219-20
32. *ibid*, p 223
33. Morris Kline, *Mathematics in Western Culture*, Oxford Press, N.Y., 1953, p 23
34. Beatrice Lumpkin, "The History of Mathematics in the Age of Imperialism," *Science and Society*, summer 1978, pp 178-84
35. J.F. Scott, *History of Mathematics*, Taylor and Francis, London, 1960, p 61, 63
36. Boyer, op. cit., p 269
37. Yushkevitch, op. cit., p 164

THE EGYPTIAN PRECURSOR TO GREEK AND "ARAB" SCIENCE

Ivan Van Sertima

1. The Judgement

Many lengthy and technical arguments have been placed before this Court by both sides—Learned Counsels for the Prosecution and the Defense and the illustrious company of expert witnesses they have summoned—in the case of the *State of New Truth vs the Grand Myth-Makers of History*. I would like those of you who have been spirited here against your will from your long deep sleep in the Underworld to appreciate our reasons for the retrial of this case towards the end of the twentieth century. As Presiding Judge of this Court, I seek the forgiveness of my learned friend, Chiekh Anta Diop of Senegal, who was posthumously persuaded to serve as Counsel for the Prosecution. I seek the apology also of expert witnesses like Otto Neugebauer for the Defense and V.V. Struve for the Prosecution for answering subpoenas served against their reluctant shades so that they could do battle as representatives of the opposing sides in this critical trial before the Tribunal of History. Also, in spite of the Court's findings, which I shall soon proceed to summarize, I cannot but express sympathy for having to recall the distantly departed scientists, Archimedes and Pythagoras, the main defendants in this case against the Greek plagiarists, to face the judgement of this Court.

Why are you here before the Bench, gentlemen? Why is it so important to us, after the lapse of so many centuries, to reopen the question of *who did what and when?* The matter at issue before this Court is *not* the matter of borrowing. It is not as simple as that. All civilizations borrow from those that precede them. One would be a fool indeed to start all over again from scratch instead of refining that which has been passed on to us by our predecessors. I think it was Leonardo da Vinci who said: "I appear tall because I am standing on the shoulders of giants." That your countrymen sat at the foot of African-Egyptian priests and teachers in their temples, some of them, like you Pythagoras, as many as 22 years, is something that has been minimized or denied but, I assure you, it is well-documented. Even the greatest of European scientists, Sir Isaac Newton, speaks loudly and clearly of your enormous debt, Pythagoras, which others have sought to deny. That you should borrow from the Egyptians is quite natural and inevitable. The

matter before this Court, as I say, is far more serious. It involves the deliberate falsification of evidence by you and your colleagues, particularly your later promoters, the deliberate refusal to give due credit to a civilization which, in your time, though not homogeneous, was predominantly African, the creation and consolidation of the impression that what you claimed to have "discovered" had no precedence. Claims such as yours, sir, in many instances, create no great harm and as such they can be forgiven. The egoism and vanity of man, after all, is well-known and to be expected. But what you and the later myth-makers, building upon your vanities, have done, is to perpetuate a dangerous and highly destructive prejudice against the darker races of man. The odious notion, so persistently cultivated that it has become an automatic reflex, that the Greeks, being Aryan, were the originators of a theoretical science while the Egyptian, too inseparably linked to African genes to rise above intellectual mediocrity, were just crude empiricists, arriving at simple recipes by dint of mundane observations, incapable of lofty flights into the stratosphere of abstraction. This has even led modern African leaders of thought, such as ex-President of Senegal, Leopold Sedar-Senghor, to declare: "Reason is Greek, Emotion is Negro."

What this has done, the Tribunal concludes, to countless generations of African peoples, what it is still doing today to the psyche of millions, relegated for half a millenia to an underclass, is frightening. It is, in our judicial opinion, *criminal*. This, then, is the motivation of this Court for attempting at this late stage a thorough reexamination of the facts of the case. This is what this Court seeks to rectify in our Judgement and Sentence.

But why have we singled you out, Archimedes and Pythagoras? Why have we separated your case from that of the other plagiarists—those countless others who, Clement of Alexandria at Stromateis tells us, would fill a volume of a thousand pages?

It is because the emphasis in this case—at least in its opening stages—suggested such a procedure. Because the Court wanted initially to deal, not with the mere matter of precedence and borrowing, which we shall present in separate and supplementary briefs, but that which we consider the source of the most deceptive and enduring racial stereotype, the posing of a complex duality of empirical-theoretical Greek science against a lower order of Egyptian empiricism.

Expert witness, Paul ver Eecke, has given testimony to this Court of a previous notion or notions behind many of your propositions, Archimedes. Notions obtained, he suggests, in ways you have said nothing about. You had dedicated your treatise on *The Method* to your friend, the geometrician, Erasthones. In this work you pointedly say that the key to your discoveries lie in your mechanical method. You boasted of actually weighing geometrical figures to confirm theoretical positions. Brilliant, Mr Archimedes. But it does not answer our most searching questions. For why, this Court has sought to know, does your famous method explain only a few of your

numerous propositions? Behind the rest, we have been persuaded to believe, by ver Eecke and other expert witnesses, lies a hidden method or methods, long-tested approaches that generated many of your propositions. Ver Eecke tells us that you had only raised a corner of the veil. Why the secrecy, sir, in a man so eager to stamp his patent on such a vast body of original thought, why be vague about the keystone method behind such an impressive field of propositions? Were you protecting your formula for originality, sir? For it is not just ver Eecke but another expert witness for the prosecution, V.V. Struve, who has tried the utmost to find the approach of the Egyptian mathematicians, that has put your claims into question. Dr Struve has shown this Court, in problem after problem (from what in our times we have come to know as the Moscow Mathematical Papyrus) that the Egyptians, whom you visited and studied, first-hand and second-hand, used an empirical-theoretical method *comparable at every point*, to that of yours. In some respects, perhaps, and Counsel for the Prosecution is more cautious, this may be an over-statement by Struve, but nothing that you have said in your work nor before this Court nor anything said by your defenders (and no one, by the way, has sought to deny your ingenuity, Mr. Archimedes, nor the refinements you have brought to the solution of certain problems), but nothing, I repeat, nothing absolves you of intellectual dishonesty, of the charge of appropriating without accreditation, brazenly and repeatedly, some of your major propositions arrived at and written down centuries before by African thinkers in the temples.

The Prosecution has presented a considerable body of well-argued and documented evidence to establish this. The Court shall confine itself in the Judgement to just three of these to demonstrate the main lines of evidence against you.

Expert witness V.V. Struve demonstrated to us that the Egyptian mathematicians established the rigorous formula for the area of the sphere. Let me quote Learned Counsel for the Prosecution, directly and in specific detail, on this matter, for, although it is an abstruse technical issue to some of us, the main case against you, Archimedes, hangs on it: "It is the identical formula" says the Prosecution "to that which gives the area of the cylinder tangent to the sphere and of a height equal to the diameter of the latter." We present now before the Court — EXHIBIT A — which shows the two figures in question, that is, the cylinder inscribed in the sphere. Note, sir, you chose this as your epitaph. You proclaimed that this was your best discovery.

Dr Struve and Dr Diop have made it patently clear to us all that the Egyptian mathematicians, and again I quote directly from the indictment, "did not fail to associate these two figures in order to arrive at an empirical-theoretical general method for the study of curved areas and volumes." How could you claim, after your travels in Egypt and the translations that were available to you even before you went there (your close friend, Erastothenes,

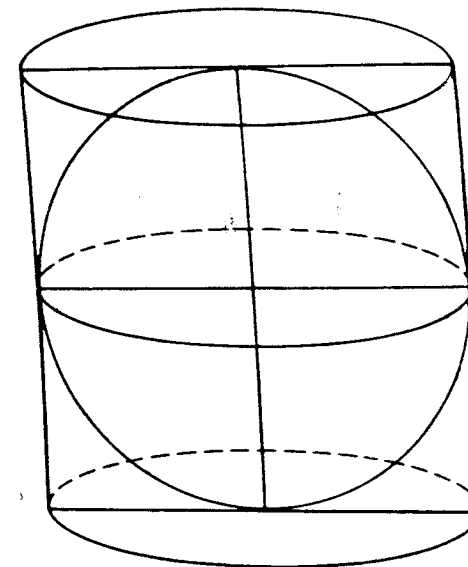

Cylinder tangential to a sphere. It is the only case where the equality between the height of a cylinder and the diameter of the circle at the base, which is also that of the inscribed sphere, is of particular interest. This figure is the one that Archimedes chose as an epitaph, because, as he said, it represented his most beautiful discovery.

a Libyan of Cyrene, was actually Head of the Library of Alexandria) that you did not know that this was an established theorem two thousand years before you were born?. And this is your epitaph, sir, your most "beautiful" discovery?

This Court has been asked to reexamine the first three propositions of your book *On the Equilibrium of Planes or of Their Center of Gravity*. You are the acclaimed discoverer of the lever or, at least, of the theory of leverage. But look at EXHIBIT B—the Egyptian scale—the first rigorous scientific application of the theory of leverage. That was way back in 1,500 B.C. And EXHIBIT C—the shadoof—the theory of leverage already expressed in a machine a thousand years before you were born. Of course we give you credit for that unforgettable phrase, about the lever enabling you "to lift up the Earth, if you had a point of support." What an ingenious formulation!

According to the Prosecution, you did the same thing with the "continuous screw." Even to this day, it is called *the Archimedean screw*. Strabo's account of the matter, as well as that of Diodorus of Sicily, suggests that this was another false claim of yours. How is it that the Egyptian screw was already in use to extract percolated water and you invented it all over again from scratch at the very same time you first visited Egypt?

We do understand that men fall victim to the habits of their cultures. Egyptian scientific legacies and developments were more or less communal in their authorship and bodies of thinking and centers of knowledge seldom, if ever, carried individual names. Your people, it seems, starting putting their names on whole complexes of things they appropriated. We cannot entirely condemn you. It had become, it is clear, a cultural habit. It was in keeping with, to use the words of Learned Counsel for the Prosecution, "a tradition of Greek plagiarism."

But enough. Centuries have passed. We are at another crossroad in time. There is need now to set the record straight if for no other reason but to put a decent end to the prejudices, rigid and implacable, that these falsifications have engendered.

We need to return to mutual respect. Respect such as Alexander the Great had for the Egyptians, even though he defeated their forces and conquered their country. Such respect, indeed, that it was his fondest wish that he be buried in the hallowed land that he had vanquished. We must abandon our imperial conceits and our individual vanities, sir. All peoples seek just credit for their deserts. Yours are the lesser, no doubt, for these questionable borrowings. But we do not agree, we cannot agree, with the extreme statement made by witness for the Prosecution, GGM James, that your people "showed no creative powers and were unable to improve on the knowledge they received." Yet we understand his anger and his hatred. It is the natural consequence of your lies, sir.

That is why we sit in judgement upon you in these final days of this

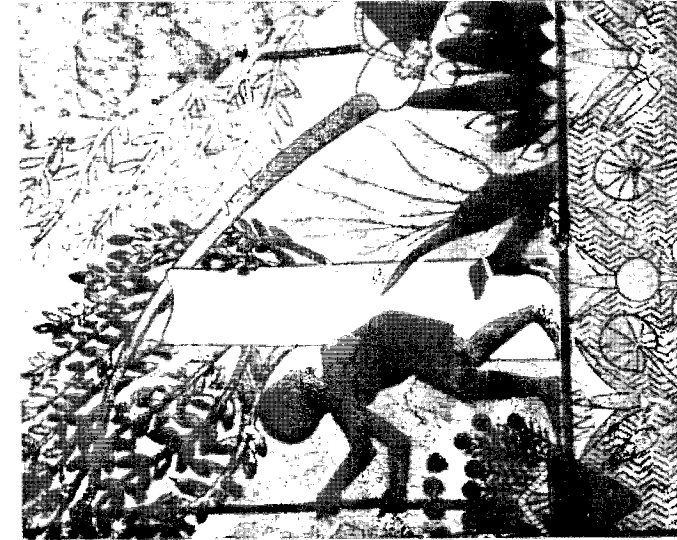

The watering of a garden using the shadoof, during the period of the New Kingdom. Application of the lever with unequal arms: the instrument that would allow Archimedes to "lift up the Earth, if he had a point of support" was already invented by the Egyptians a thousand years before his birth. (Norman de Garris Davies, *The Tomb of Two Sculptors at Thebes*, fig. 28)

Exhibit C

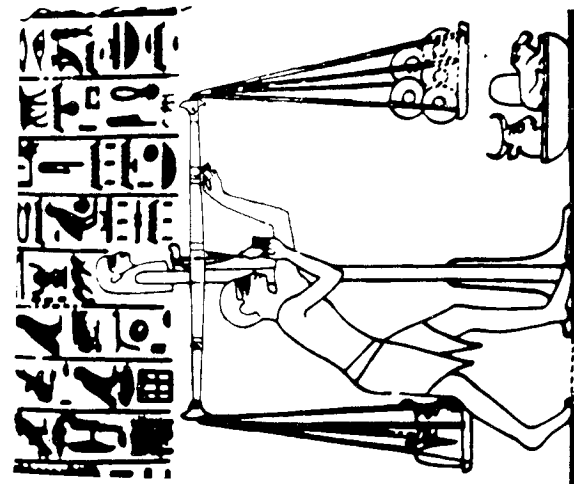

Egyptian balance with cursors. Notice the initial symmetry of the position of the ring-shaped cursors that the operator is manipulating in order to adjust the weight. These submultiples of weight, whose displacement caused the changing of the center of gravity of the system, show that the Egyptians had to have mastered the theory of leverage, as confirmed by Exhibit C, which represents a lever in the most general sense, with two unequal arms and a counterweight at one end, in order to draw water with a minimum amount of effort. The "point of support" of Archimedes was already there, two thousand years before his birth. (The weighing of golden ingots, around 1500 B.C. Taken from Norman de Garris Davies, *Rekhmire*, fig. LIV)

Exhibit B

millenium. We sentence your reputation to be suspended, Archimedes, the history concerning your most vaunted achievements to be scrupulously re-examined and revised. We enjoin you, with all the authority vested within us, to bring the force of your spirit to weigh upon the conscience of your contemporary promoters, so that they may own up to the debt you owe to the African people. Thus may you redeem, without eternal blemish, that which you have truly given to the world.

As for you, Pythagoras, the judges are divided as to whether you deserve the same type of condemnation. The theorem that carries your name, as expert witnesses P.H. Michel and Beatrice Lumpkin have shown, is certainly not original. Learned Counsel for the Prosecution has gone into this matter in very minute detail. Because this case touches on things that concern us all, not just the mathematicians, and because the gallery is filled with more laymen than specialists, I had wanted to avoid, as much as possible, citing formulas in a manner as may be understood only by the privileged few. But in this particular instance the Court deems it necessary to quote Dr Diop chapter and verse, for, like the vaunted epitaph of Archimedes, this was to become the foundation of your reputation, sir.

“The Egyptians knew,” (and I am quoting the words of the Prosecutor) “how to rigorously extract the square root, even of the most complicated whole or fractional numbers. The term that served to designate the square root in the Pharaonic language is significant in that respect: the right angle of a square, *knbt*; “to make the angle” = to extract the square root. The Egyptians defined a fundamental unit of length called the “double remen,” which is equal to the diagonal of a square of little side $a =$ one royal cubit; in other words, if d is diagonal, then one necessarily has, by definition of this length itself, the “double remen.”

$$d = a\sqrt{2} = (\sqrt{2} \times 20.6) = 29.1325 \text{ inches}$$

The royal cubit = 20.6 inches
 The remen = $d/2 = \sqrt{2}/2a = 14.6$ inches

“The Egyptians, who thus determined the diagonal of the square from the value of the side and who mastered the calculation of the extraction of the square root, knew, as the definition above proves:

“The irrational number par excellence, which is 2, as they also knew the transcendent number (also irrational).

“The theorem of the square of the diagonal (falsely attributed to Pythagoras) at least in the case of the isosceles right-angled triangle.”

The Court has also determined that there are other innovations ascribed to you or to your followers, the Pythagoreans, which should really be credited to your teachers. Thales of Miletos had been a student in the Egyptian Houses of Life before you. He also enunciated a theorem that is prefigured by Problem 53 of the Rhind Papyrus (as we have come to call a certain

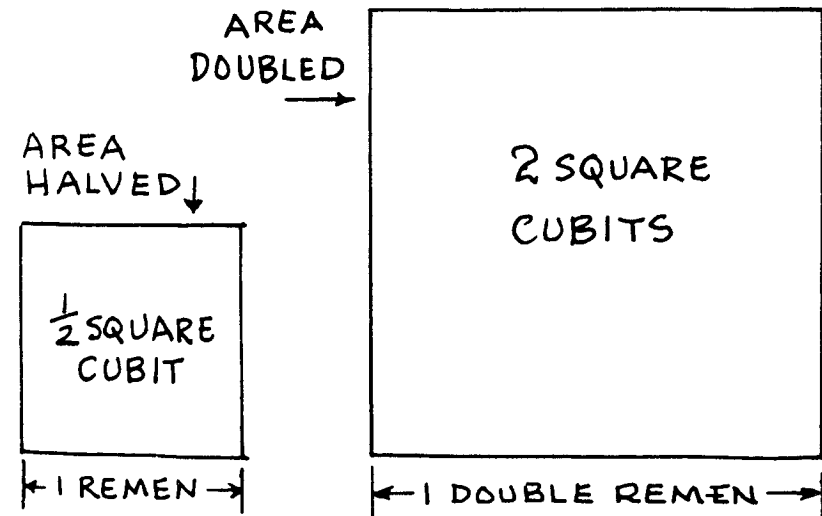
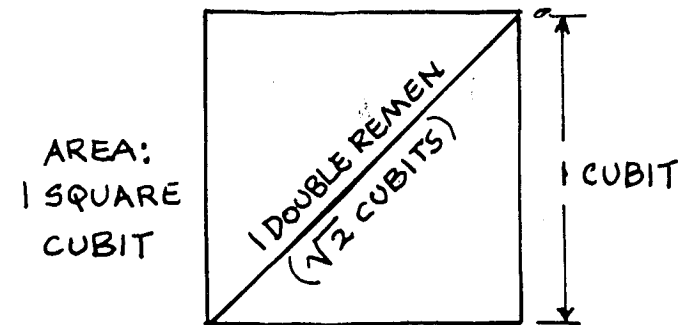
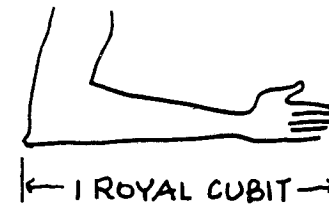

Egyptian Measurements. Relationships between cubit, double remen, and remen give an example of so-called Pythagorean theorem that $1^2 + 1^2 = (\sqrt{2})^2$. (From Lumpkin, *Senefer and Hatshepsut*, p. 55)

fragment that survived the dynastic Egyptians). It was written by them thirteen hundred years before his birth. He was the one, we understand, who began the great pilgrimage of aspiring Greek scientists to Egypt. You were his star-pupil, Pythagoras. You went on from that early mentoring to spend half of your adult intellectual life in Africa. The problem that faces this Court in passing judgement upon you is that we are not unanimously certain that you enunciated the so-called Pythagorean theorem or introduced such theories as "The Harmony of the Spheres" with naked intent to defraud, that is, to appear the original, sole or primary inventor thereof. Yet Herodotus calls you a simple plagiarist of the Egyptians. Even your biographer, Jamblichus, has told us that all the theorems of lines, which we now call geometry, came out of Egypt. This Court, however, rules that it is more the shrill and arrogant claims of your later supporters than any proven individual claim or boast of yours that has given your plagiarism such prominence. The Court finds it, therefore, only necessary in your case to expose the facts, so that the origin of the theorem that bears your name can now be given its rightful attribution. We can pass no clear judgement upon you, for the members of the Tribunal are divided on the matter of your personal culpability.

It is impossible to exhaust in this Judgement the enormous debt you and your countrymen owe to the Egyptian mathematicians. It is equally impossible for me to repeat the lengthy proofs and arguments that have been advanced to establish the precedence of so many formulae. But I cannot conclude this Judgement without mentioning a few of these—the formulae for the area of a sphere and the length of the circumference, for the volume of a cylinder, for the area of a circle, for the measurement of the pyramid and the cone (once again, falsely attributed to a Greek—Eudoxus of Cnidus) the volume of a pyramid and a truncated pyramid, the exact value of pi (3.16) never so accurately calculated until the most recent of times, the first use of trigonometric lines, and on and on and on.

Deeply though we deplore the shadow that the Greek conquest cast over the scientific reputation of the Egyptian, the enormous legacy not only in mathematics but in physics, astronomy, medicine, metallurgy, and mechanics, that your people may have claimed and appropriated, it must be pointed out, in all fairness, that at least you showed respect, sometimes bordering on awe, for your teachers. You would never have encouraged, you would never have dreamt to decree, the burning of the Library of Alexandria, as that religious bigot, Theodosius, seems to have done. And had you not sat, for the best part of your intellectual lives, in the temples of the Egyptians, had you not taken and transmitted, and, in some cases, refined what they had to teach you, the later Arab conquerors of Egypt, who had never seen a pyramid, an obelisk, or a sphinx, who could not read hieroglyphic inscriptions, would have had a slim scientific tradition to build upon. So few of them,

alas, let it be recorded by this Court, since we must apportion both credit and blame for the events of history, so few of them gave credit to the native genius of the people they conquered, and have, through later accretions of prejudice, falsely assumed and falsely declared that your translations and transmissions were wholly works of your own. Granted that their memory and imagination, their vision of the past, was later colonized by European rulers but they have contributed, in no mean measure, to the Grand Myth that your tradition of plagiarism created.

2. Supplements to the Indictment

Apart from the Judgement we have handed down against the chief plagiarists, Archimedes and Pythagoras, the Tribunal has prepared, on the basis of evidence given by other experts, a number of supplementary briefs on the Egyptian contributions to science in the age when it was dominated and inspired by the African genius. This is indeed a vast and complex field and no one scholar can ever encompass it. That is why we have summoned a team of experts.

Few men live these days in a Renaissance world. One is considered a romantic dabbler if one attempts, like an ancient Imhotep or a medieval Da Vinci, to inhabit more than one room in the house of knowledge. Knowledge, indeed, has exploded so rapidly that specialists feel compelled to knit the spokes of their brains to the hub of a single discipline. Laymen, on the other hand, are too far removed from what appears to them to be "mystery systems" to grasp the grand poetry of mathematics, the interior cosmic order and beauty behind so many of these cryptic but critical revelations. That is why this Court feels it must add a corollary to the Judgement. We feel that the time has come for all people to rethink and re-sense the multi-racial genesis and legacy of man. We see it as our duty, in the light of the evidence these experts have brought before us, to demonstrate a balance, in the contribution to civilization, between the races. It is too late, alas, to pass sentence of death on the Myth-Makers but we must unseal and reveal the full indictment against them, since we consider the Grand Myth of European scientific hegemony and African intellectual inferiority to be the most cruel, the most pervasive, the most divisive myth and fantasy of man.

This Court shall now adjourn. When we resume we shall present a formidable body of evidence in several fields—physics, medicine, mechanics, metallurgy, agriculture, architecture and astronomy. Until then, thank you, ladies and gentlemen, thank you.

— TO BE CONTINUED —

References

1. Cheikh Anta Diop, *Civilization or Barbarism*, (trans. from the French by Yaa-Lengi Meema Ngemi) Lawrence Hill Books, 1991. This is absolutely necessary reading for all students of African Civilizations, especially the chapter "Africa's Contribution to the Sciences." See also *Great African Thinkers—Cheikh Anta Diop*, Journal of African Civilizations, Vol 8, No. 1, 1986 (edited by Ivan Van Sertima and Larry Williams) This book should return to print in the summer of 1992.
2. Beatrice Lumpkin, "Africa in the Mainstream of Mathematics History" in *Blacks in Science*, Vol. 5, 1984, Journal of African Civilizations (edited by Ivan Van Sertima)
3. Richard J. Gillings, *Mathematics in the Time of the Pharaohs* (London: MIT Press, 1972)
4. T. Eric Peet, *The Rhind Mathematical Papyrus*, The University Press of Liverpool, 1923.

AN ANNOTATED BIBLIOGRAPHY OF THE MOORS IN SPAIN, 711–1492*

James J. Ravell

A. General Bibliographies, Encyclopaedias, and Periodicals

01. Abdulrazak, Fazwi, compiler. *Arabic Historical Writing 1974: an Annotated Bibliography of Books in History from all Parts of the Arab World*, Cambridge, Mass: Harvard University Library, 1976. xi, 258 pp. "Supplement, 1973," pp. 241–257; Indexes.
Annotations are in English of works written in Arabic. Only a few entries concern Moorish Spain directly.
02. Abdulrazak, Fazwi, compiler. *Arabic Historical Writing, 1975 and 1976: an Annotated Bibliography of Books in History from all Parts of the Arab World*, London, Mansell, 1979. xviii, 210 pp., 23 cm. Includes Indexes.
03. *Al-Andalus* (Madrid), 1933–1978. Ceased publication. Al-Andalus was the Arabic name for Moorish Spain that at one stage included parts of present-day Portugal. Articles are mostly in Spanish, on all aspects of Spain under the Moors. Bibliographies were regularly published.
04. *al-Qantara* (Madrid), Vol. 1 (1980 –); semiannual; irregular; ill.; 23 cm.
Continues: Al-Andalus.
Articles mostly in Spanish, but occasionally also in English and French.
05. Anderson, Margaret, compiler, *Arabic Materials in English Translation. a bibliography of works from the pre-Islamic Period to 1977* (A Reference Publication in Middle Eastern Studies), Boston, Mass., G.K. Hall & Co., 1980. xiii, 249 pp., Index.
Contains various items on Moorish Spain.
06. *The Concise Encyclopaedia of Islam*, compiled by Cyril Glassé, London, Stacey International, 1989. 472 pp.; col. ill., maps; Chronology; Bibl.: pp. 468-472.
Contains brief entries for Al-Andalus, Almoravids, Almohads, and the main Moorish scholars. See also nos. 08-10 below.

* The main focus of this Bibliography is on works (primarily books) in the English language. For Arabic and Spanish works, see especially Chejne, Anwar G., Muslim Spain (1974), no. 54 below.

07. Ede, David and Librande, Leonard *et al.*, compilers. *Guide to Islam*, Boston, Mass, G.K. Hall & Co., 1983.
Fully annotated bibliography on all aspects of Islam. Numerous entries deal with Moorish Spain.
08. *The Encyclopaedia of Islam*. 4 vols & supplement. London, Luzac; Leiden, Brill (1913-38); new ed.: (1960-1978), 4 vols; 1979-82, *Vol. 5 (KHE-LA)*, Leiden, Brill, 1981. Bibliographies and maps. *Vol. 6. Facsicles 105-106 Man-Mar'ashis*, Leiden, Brill, 1988, 512 pp.
Vol. 1 A-B of new ed. (1960) contains an overview of the history and culture of Al-Andalus. See also items on various persons and movements.
09. *The Encyclopaedia of Islam*. 2nd ed., prepared by a number of leading Orientalists. Edited by J.H. Kramers, H.A.R. Gibb and E. Levi-Provençal, under the patronage of the International Union of Academies, Leiden, Brill, (1954 -).
10. *The Encyclopaedia of Islam*. New ed.: Supplement, prepared by a number of leading orientalists; edited by C.E. Bosworth [*et al*], assisted by F. Th. Dijkema, M. Lefort and S. Nurit, under the patronage of the International Union of Academies, Leiden, Brill, (1980 -).
11. Grimwood-Jones, Diana, Hopwood, Derek *et al.* *Arab Islamic Bibliography: the Middle East Library Committee Guide*, based on Guiseppi Gabrieli's *Manuale di bibliografia musulmana*, Hassocks, U.K., Harvester Press/Atlantic Highlands, N.J., Humanities Press, 1977. xvii, 292 pp., Index.
12. Grose, David D., general editor. *A Select Bibliography of History*, compiled by the The Henry Adams History Club, Harvard University, Cambridge, Mass., Harvard University Press, 1970. 4th ed. xi, 428 pp. No annotation.
Contains sections on Medieval Islam, 600-1500, and Medieval Spain, 711-1469.
13. *An Historical Atlas of Islam*, compiled by William C. Brice, under the patronage of the *Encyclopaedia of Islam*, Leiden, Brill, 1981. viii, 71 pp., chiefly col. maps; 41 cm. Includes Bibl. refs. and Indexes.
Shows worldwide expansion of Islamic states, with special maps of Moorish Spain and North Africa.
14. *Index of Islamic Literature*, Regular Supplement to *The Muslim World Book Review* (Leicester, U.K.).
Covers new publications in English on the entire Islamic world, past and present. See also below, no. 22.
15. *Index Islamicus: 1665-1905* A bibliography of articles on Islamic subjects in periodicals and other collective publications, compiled by Wolfgang Behn. Millersville, PA, Adiyok, 1989. xxx, 869 pp.; ill.
Contains thematic and geographical divisions, and coverage of

- Moorish Spain and North Africa.
16. *Index Islamicus: 1906-55*, compiled by J. D. Pearson, with the assistance of Julia F. Ashton, Cambridge, UK, W. Heffer & Sons, 1958. xxxvi, 896 pp. A catalogue of periodical articles and other collective publications.
Contains a special section on Muslims in Spain and Italy.
17. *Index Islamicus. Supplement. 1956-1960*. A catalogue of articles on Islamic subjects in periodicals and other collective publications, compiled by J.D. Pearson. Cambridge, Heffer & Sons Ltd., 1962. xxviii, 316 pp. Also Supplement 1961-65 (1967); Supplement 1966-70 (1972); Supplement 1971-75 (1977).
18. *Index Islamicus 1976-1980. Part 1: Articles*, compiled by J.D. Pearson, London, Mansell, 1983. xliii, 539 pp. Index.
Contains both thematic and geographical divisions.
19. *Index Islamicus 1976-1980. Part 2: Monographs*, compiled by J.D. Pearson and Wolfgang Behn. London, Mansell, 1983. 348 pp. Index. Both thematic and geographical divisions.
Contains a section on North Africa and Spain.
20. Littlefield, David W. *The Islamic Near East and North Africa. An Annotated Guide to Books in English for Non-Specialists*, Littleton, Colo., Libraries Unlimited, Inc., 1977. 375 pp; Indexes.
A useful guide.
21. Marin, Manuela. "Arabic-Islamic Libraries and Bibliography in Spain," *Bulletin*, British Society for Middle Eastern Studies, 11 (No.2, 1984), 180-184.
22. *Muslim World Book Review*, quarterly publication of the Islamic Foundation, Leicester, U.K. (Autumn 1981 - .)
Covers new publications on the global Islamic world, past and present. Features include Book Reviews and New Books Received. See also above, no. 14.
23. *The New Encyclopaedia Britannica. Macropaedia. Knowledge in Depth*. Vol. 22. 15th ed. Chicago, Ill., Encyclopaedia Britannica, 1990. Ill.
Contains a good brief section on Moorish Spain, and an up-to-date select Bibliography on Islamic history and culture.
24. *The Quarterly INDEX ISLAMICUS. Current Books. Articles and Papers*, compiled by G.J. Roper, Cambridge, [University Library]/London, Mansell Publishing Ltd., (1976 -).
Contains an annual Index of Subjects and Names. Thematic and geographical divisions. Has a special section on Moorish Spain.
25. *Recently Published Articles*. Washington, DC., American Historical Association. Vol. 1. (Feb. 1976 -).
Appears 3 times per year. Geographical divisions, treated chronologically. The section on medieval Spain covers the Moors.

26. Ronart, Stephan, and Nandy Ronart. *Concise Encyclopaedia of Arabic Civilization*, vol. 2, *The Arab West*, New York, Praeger, 1966. vii. 413 pp., maps; tables of rulers; Bibl.: 408–409. No Index.
A brief overall historical introduction to the Islamic civilization of North Africa and Spain.
27. Roolvink, Roelof et al, compilers. *Historical Atlas of the Muslim Peoples*, Cambridge, Mass., Harvard University Press/Amsterdam, Djambatan, 1969. iv, 40 pp.
Comprises 56 maps with annotation, covering the whole Islamic world chronologically, including Moorish Spain.
28. Sauvaget, Jean (1901–1950), *Introduction to the History of the Muslim East. a bibliographical guide*, based on the 2nd [French] ed., as recast by Claude Cahen, Berkeley/Los Angeles, University of California Press, 1965. xxi, 252 pp.; Index of Names; Part III: Historical Bibliographies.
Chapter 24 covers the Muslim West (North Africa, Sicily and Spain), and Chapter 25 deals with the influence of Muslim culture in Europe.
29. Shields, Graham J., compiler. *Spain* (World Bibliographical Series, vol. 60), Oxford, U.K./Santa Barbara, CA, Clio Press, 1985, xxxvi, 340 pp.; map; Index.
Contains only a few items on Moorish Spain. Although the author acknowledges the great impact of the Moors on Spanish civilization for almost 800 years, his List of Rulers of Spain starts with Isabella I of Castille and Ferdinand II of Aragon (1479–1504).
30. Wilgus, Alva Curtis, compiler. *Latin America. Spain and Portugal. a selected and annotated bibliographical guide to books published in the United States. 1954–1974*, Metuchen, N.J., Scarecrow Press, 1977. xv, 910 pp. Index.
Contains only a few items on Moorish Spain.
- B. General: History and Culture**
31. Abel, Armand. "Spain: Internal Division," in Von Grunebaum; ed., *Unity and variety in Muslim Civilization* (1955), pp. 207–230.
For full bibliographical details, see below, no. 149.
32. Abercrombie, Thomas J., "When the Moors ruled Spain," *National Geographic*, 174 (July 1988), 86–119. Photographs (in color) by Bruno Barbey. Map; Calendar of Events.
A journalistic account of the Moors in Spain and Morocco in the form of a modern travelogue.
33. Abun-Nasr, Jamil M. *A History of the Maghrib in the Islamic Period*, Cambridge, U.K./New York, Cambridge University Press, 1987. Rev. and expanded version of the 1975 edition. xvi, 455 pp. Bibl.: pp. 429–439; Index.

- Includes a political history of Moorish Spain, with the emphasis on the two Berber or African dynasties, namely the Almoravides and the Almohads.
34. Ahmad, Aziz, *A History of Islamic Sicily* (Edinburgh University Islamic Surveys, 10), Edinburgh, Edinburgh University Press, 1975. xii, 147 pp. Ill.; map; Bibl.: pp. 124–136; Index.
The author gives an historical overview of the Muslim presence on Sicily and of the transmission of the Islamic legacy through Sicily and Italy. The book provides an interesting comparison with contemporaneous Moorish Spain.
35. Ali, Ameer (1849–1928). *A Short History of the Saracens, being a concise account of the rise and decline of the Saracenic power and the economic, social and intellectual development of the Arab nation, from the earliest times to the destruction of Bagdad and the expulsion of the Moors from Spain*, London/New York, MacMillan, 1899. xix, 638 pp. geneal. tables, fold. maps, plates. Bibl.: 626–627; Index. Several chapters refer to Moorish Spain, with attention also given to cultural contributions.
36. Altamira y Crevea, R.. "Western Caliphate," in *Cambridge Mediaeval History*, edited by H.M. Gwatkin et al. Vol. 3: *Germany and the Western Empire*, Cambridge, Cambridge University Press, 1957. Ch. XVI, 409–442. Chapter Bibl.: pp. 631–635.
Comprises an overview of the history of Moorish Spain up to the Umayyad Period (11th century).
37. Arié, Rachel. *L'Espagne musulmane au temps des Nasrides (1232–1492)*, Paris, Editions E. de Boccard, 1973. 528 pp. maps. pls.; geneal. tables. Bibl.: [13]-26
The Nasrids of Granada were the last Moorish Dynasty in Spain. Besides political history the book also deals with cultural developments, society and institutions.
38. Arié, Rachel. *Etudes sur la civilisation de l'Espagne musulmane*, Leiden/New York, Brill, 1990. (Medieval Iberian Peninsula Texts and Studies, vol. 6), viii, 286 pp.; ill.; Bibl. refs.; Indexes.
A collection of previously published articles (between 1965 and 1987) on various aspects of the history and culture of Moorish Spain and its relations with Northwest Africa.
39. Atiyah, Edward, *The Arabs. The origins, present conditions, and prospects of the Arab World* (Pelican Books, A 350), Harmondsworth, Middlesex, U.K., Penguin Books, 1958. rev. ed. 250 pp.; maps; No Bibl.; no Index.
The term "Arabs" is used here in a cultural sense. A good overall survey. Chapter 2: "The Place of the Arabs in History" includes a discussion of the Moors in North Africa and Spain.

40. Bosworth, Clifford E. *The Islamic Dynasties. a chronological and genealogical handbook* (Islamic Surveys, 5), Edinburgh, Edinburgh University Press, 1967. xviii, 245 pp.; Bibl. refs.; Indexes.
Chapter 2 covers North Africa and Spain.
41. Bovill, E.W. *The Golden Trade of the Moors*. 2nd ed. revised and with additional material by Robin Hallett, London/New York, Oxford University Press, 1970, xvi, 293 pp. Bibl.: 269-271; Index.
The focus is on the Moorish trans-Saharan trade and the Western Sudanese states. Themes discussed include the Almoravides, the Almohads, Ibn Battutah, Ibn Khaldun, and Leo Africanus.
42. Brockelmann, Carl (1868–1956). *History of the Islamic Peoples*, with a review of events, 1939–1947, by Moshe Perlman. Eng. trans. by J. Carmichael and M. Perlman, New York, Putnam's, 1947, xx, 582 pp., 8 maps, 1947; New York, Capricorn Books, 1960. xiix, 582 pp; Bibl.: 539-549. Index.
Contains a section on Moorish Spain and North Africa.
43. Brown, Marguerite. *Magnificent Muslims: the Story of Spain's Arab Centuries*, New York, New World Press, 1981. 112 pp. Review.
44. Irving, T.B. *Muslim World Book Review*, 4, no. 2 (1984), 33–36.
A critical review which itself contains two (typographical) errors, making the Umayyad dynasty still ruling in Spain in the "eighteenth" and the "nineteenth" centuries.
45. Burckhardt, Titus. *Moorish Culture in Spain*, translated [from the German] by Alisa Jaffa, London/New York, McGraw Hill, 1972. 219 pp., Ill. (part. col.); maps; plans; Sel. Bibl.: pp. [221]–222; Index.
A discussion of all aspects of culture: arts, sciences, philosophy, literature, religion, and recreation.
46. Burns, Robert I. *Islam under the crusaders: colonial survival in the thirteenth-century kingdom of Valencia*, Princeton, Princeton University Press, 1973. xxxi, 475 pp.; ill. Bibl.: pp. 421-456; Index.
47. Burns, Robert I. *Medieval Colonialism: Postcrusade Exploitation of Islamic Valencia*, Princeton, Princeton University Press, 1975. xxiv, 394 pp., Bibl.: pp. 349-375; Index.
The emphasis is on the tax system as instrument of Moorish exploitation.
48. Burns, Robert I. *Moors and Crusaders in Mediterranean Spain* (Collected Studies series, no. 73), London, Variorum Reprints, 1978., 328 pp, ill., Bibl. refs.; Index.
Reprints of previously published articles that deal with various aspects of Moorish-Christian relations.
49. Burns, Robert I. *Muslims, Christians, and Jews in the crusader kingdom of Valencia: societies in symbiosis* (Cambridge Iberian and Latin American Studies), Cambridge, UK./ New York, Cambridge University

- Press, 1984. xx, 363 pp. ill., Bibl.: pp. 331–345; Index.
50. Calvert, Albert F. (1872–1946). *The Alhambra*, London, G. Philip & Son, 1904. vii, 464 pp.; including 80 col. plates; front. (port.).
The Alhambra is the famous Red Palace built by the Moors in Granada in the 14th century. Its Court of the Lions is particularly impressive.
See also Irving, Washington, no. 96 and Bargebuhr, Frederick P., no 243 below.
51. Castro, Amerigo (1885–1972). *The Structure of Spanish History*, transl. from the, Spanish by E. L. King, Princeton, Princeton University Press, 1954. Bibl. footnotes. A Revised translation of the author's *España en su historia: cristianos, moros y judios*, Buenos Aires, 1968.
The author's argument is that post-1492 Christian Spain was not a continuation of the earlier Visigothic Spain but developed out of the mixed Moorish culture.
Criticism:
See Monroe, James T. below, no. 189.
52. Chandler, Wayne B. "The Moor: Light of Europe's Dark Age, " in Van Sertima, Ivan, ed., *African Presence in Early Europe* (1985), pp. 144–175. Ill., map, & Bibl. refs.: pp. 173–175.
For full bibliographical details, see Van Sertima, ed., no. 146 below.
The laudatory intent of Chandler has been to provide an Afrocentric historical overview of the Moors in Spain, beginning with a definition of the term "Moors". Unfortunately, the quality of the essay is marred by sloppy scholarship (perhaps due to an overreliance on secondary sources not directly dealing with Moorish Spain): e.g. confusion between "Moors" and "Muslims"; the term "Gibraltar" is derived from "Jabal Tariq," which does not mean, as the author asserts, "General Tariq" but "Mount(ain) of Tariq," (Tariq ibn-Ziyad was the African general who led the Moorish invasion of Spain in 711); the author erroneously describes the Almohade Dynasty as "the fourth and last Moorish Dynasty" in Spain; furthermore, there is no mention whatsoever of either the Nasrids, the actual last Moorish Dynasty in Granada (1231–1492), or, surprisingly, of that fateful year in World History 1492.
53. Chejne, Anwar G. "Some remarks on Hispano-Arabic culture," *Islamic Literature*, (12 May 1966), 49–54; (Nov.), 19–28.
54. Chejne, Anwar G. *Muslim Spain, its history and culture*, Minneapolis, University of Minnesota Press, 1974. xvi, 559 pp. Extensive Bibl. refs. (Notes): pp. 420-482; Bibl. of Catalogues & Mss.: pp. 485-490; Bibl. of Western Works: pp. 491-516; Bibl. of Eastern Works (mostly Arabic): pp. 517–530; Ill.; maps; Index.
An indepth study of the history and culture of Moorish Spain. Copi-

ous references to primary sources. The book is stronger on the cultural achievements of the Moors than on their history.

The bibliographies constitute a valuable resource for Moorish Spain.

55. Chejne, Anwar G. *Islam and the West: the Moriscos, a cultural and social history*, Albany, State University of New York, c 1983. viii, 248 pp. Bibl.: pp. 216–238; Index.

Discusses the history of the Muslims in Spain who shortly after the reconquest in 1492 were forced to become baptized Christians or face persecution, in direct violation of the Granada treaty of surrender. They were derogatorily called Moriscos which is Spanish for “Little Moors”. According to the author, the Moriscos were “(b)orn and reared in the Iberian Peninsula of mixed ancestry (Spanish, Jewish, Berber, Arab and other ethnic groups)” and “considered aliens in their own land, heretics who presented an imminent danger to the state and church.”

Review:

56. Faris el-Mansoury, *Muslim World Book Review*, 7, no. 2 (1987), 39–41.

On the Moriscos, see also Lea, Henry C., no. 107, Monroe, James T., no. 125, and Gayangos, P. de, no. 251 below.

57. Christopher, John B. *The Islamic Tradition*, New York, Harper & Row, 1972. xxii, 185 pp.; chronology; 2 maps; Bibl.: 166–177; Index.

A brief introduction to the subject. Several references to Spain. In the chapter on Philosophy Averroës and Ibn Khaldun are discussed.

58. Collins, Roger. *Early Mediaeval Spain. Unity in Diversity, 400–1000*, London, MacMillan, 1983. xx, 317 pp.; tables; maps; bibliographies.

The book stresses the pre-Moorish period and gives attention to the Umayyad dynasty.

Review:

59. Abdul Wahhab Boase, *Muslim World Book Review*, 5, no. 3 (1985), 53

A brief assessment in which the reviewer rightly asserts that “...like most books by Western academics, no reference is made in the footnotes to any modern publications on Islam by Muslim scholars.”

60. Collins, Roger. *The Arab Conquest of Spain. 710–797*, Oxford, U.K./New York, Basil Blackwell, 1989. xii, 239 pp.; Bibl. refs.; Index.

The book focusses on the political and cultural history of the first century of Moorish rule in Spain.

61. Conde, Jose A. (d. 1820) *History of the Dominion of the Arabs in Spain*, trans. fr. the Spanish by Mrs Jonathan Foster, London, G. Bell & Sons, 1854; 1909–1913. 3 vols. Vol 1: iv, 511 pp. Spanish original published posthumously in 1820–1821; 2nd ed. Barcelona, 1844.

A detailed political history.

Criticism:

See Monroe, James T. below, no. 189. According to Monroe, Conde’s was a pioneering work that established an historical framework for the study of Moorish Spain. Conde’s work had wide influence on European Romantics and on Americans like Washington Irving whose own writings in turn further fueled a romantic interest in Moorish Spain.

62. Coppée, Henry (1821–1895). *History of the Conquest of Spain by the Arab-Moors*, Boston, Little, 1881.

63. Creasy, Edward (1812–1878). *The Fifteen Decisive Battles of the World. from Marathon to Waterloo*, London, 1862. New ed.: New York, T.Y. Crowell, 1918. xiii, pp. 535.

One of the battles described is the Battle of Tours (732), near Poitiers, southern France, where a Moorish army was defeated by the Frankish ruler, Charles Martel, the grandfather of Charlemagne.

64. Daniel, Norman. *Islam and the West: the making of an image*, Edinburgh, Edinburgh University Press, 1962. ix. 443 pp. ill.; Bibl.: pp. 395–427; 1980, xi, 448 pp.; Bibl.: pp. 395–432; Index.

65. Daniel, Norman. *The Arabs and Medieval Europe*. (Arab Background series) London, Longman, 1975; 2nd ed., London/New York, Longman/Beirut, Librairie du Liban, 1979. xiv, 378 pp. [2] leaves of plates; ill.; Bibl.: 356–357; Index.

Contains many references to Moorish Spain.

66. deGraft-Johnson, J(ohn).C., *African Glory. The Story of Vanished Negro Civilizations*, Baltimore, Black Classic Press, 1986. 1st pub. 1954. Afterword J.H. Clarke. Ch. 7, pp. 68–76, deals with the Moors in Spain.

Though brief, this Ghanaian historian’s treatment of the Moors is refreshingly Afrocentric, as is the whole book which was a pioneering study when it first appeared in 1954.

67. Dozy, Reinhart P. A. (1820–1883), *Spanish Islam: a history of the Moslems in Spain*, tr. with a bibliographical introduction and additional notes by Francis Griffin Stokes, London, Chatto & Windus, 1913. xxxvi, 769 pp. fold. map; “Authorities”:pp. 742–747. The French original, *Histoire des Musulmans d’Espagne. 711–1110*, later revised and published in 3 volumes (Leiden, 1932) by E. Lévi-Provençal, for long remained the standard historical work on Moorish Spain. A Dutch scholar of Islam, Dozy was highly critical of Conde’s work on Moorish Spain. The book only deals with the period 711–1110

Criticism:

See Introduction by Stokes, and Monroe, James T., no. 189 below.

68. Draper, John W. (1811–1882). *A History of the Intellectual Development of Europe*, New York, Harper, 1863, xii, 631 pp. Index. No Bibl. refs.; No Bibliography.

The author provides a brief overview of the Moorish intellectual achievements in Spain and their impact on developments in Europe.

69. Dunlop, D(ouglas) M. *Arab Civilization to A.D. 1500*, London, Longman, 1971. x, 368 pp.; Bibl. refs.; Index.

The book includes references to Moorish contributions in North Africa and Spain in the fields of literature, historiography, geography, philosophy and science. A most welcome feature of the book is its special chapter on "Some famous Women in Islam".

70. Durant, Will(iam) J. (1885–1881) *The Story of Civilization. Vol. 4. The Age of Faith. A History of Medieval Civilization—Christian, Islamic, and Judaic—from Constantine to Dante, A.D. 325–1300*, New York, Simon and Schuster, 1950. xviii, 1196 pp.; Ill. Bibl.: pp. 1087–1100; Index.

The author defines the Moors as "the Moslem population partly Arab, mostly Berber—of Western North Africa and Spain." (p. 298n.)

Chapter XIII deals with Western Islam, 641–1086, and includes a discussion of developments in Northwest Africa (Maghrib) and Spain (al-Andalus). Chapter XIV: "The Grandeur and Decline of Islam: 1058–1258" includes a description of the Moorish civilization, science and philosophy in Spain up to the middle of the thirteenth century.

71. El Fasi, M., ed., *Unesco General History of Africa. Vol. 3: Africa from the Seventh to the Eleventh Century*, Paris, Unesco/London, Heinemann, Berkeley, University of California Press, 1988. xxv, 869 pp; ill. maps; Bibl.: pp. 799–847.

See especially Chapter 13: "The Almoravids" by I. Hrbek and J. Devisse, pp. 336–366.

See also Niane, D.T., ed., no. 128 below.

72. Faris, Nabih A. and Hitti, Philip K. et al., eds., *The Arab Heritage*, Princeton, Princeton University Press, 1944; New York, Russell & Russell, 1963. x, 279 pp.; ill.; Bibliographies; Index.

Chapters cover literature, scientific thought and art also in Moorish Spain.

73. Gibb, Hamilton A.R. (1895–1971). *Studies on the Civilization of Islam*, edited by Stanfrd J. Shaw and William R. Polk, Boston, Beacon Press/Toronto, S.J. Reginald Saunders, 1962. Bibl. Notes; Bibliography of Gibb's Works (1923-1961): pp. 345–357; Index.

The book comprises a collection of previously published articles on themes like the interpretation of Islamic history, Arabic Historiography, and Ibn Khaldun's Political Theory.

74. Glick, Thomas F. *Islamic and Christian Spain in the Early Middle Ages*, Princeton, Princeton University Press, c. 1979. xi, 376 pp. ill. map; figures, Notes; Bibl.: pp. 301-316; Index.

The Introduction includes a segment on "Culture Contact and the

Polemic of Spanish Historiography." The book is divided into 2 parts: I: Society and Economy; II: Movement of Ideas and Techniques.

75. Goldziher, Ignace. "The Spanish Arabs and Islam: The Place of the Spanish Arabs in the Evolution of Islam as Compared with the Eastern Arabs," *The Muslim World*, 53 (1963), 5–18, 91–105, 178–184, 281–6; 54 (1964), 27–38.

76. Guichard, Pierre. *Al-Andalus: estructura antropologica de una sociedad islamica en Occidente* (Breve Biblioteca de Reforma, 16), Barcelona, Barral Editores, 1976. 616 pp.; maps; Bibl.: pp. 577–610; Index. Transl. of *Tribus arabes et berberes en Al-Andalus*.

77. Guichard, Pierre. *Structures sociales, "orientales" et "occidentales" dans l'Espagne musulmane*, (Civilisations et sociétés, 60), Paris, Mouton, c. 1977. 427 pp.; maps; Bibl.: [353]–380.; Index.

A discussion of the political and social conditions in Moorish Spain.

78. al-Hajji, 'Abd al-Rahman 'Ali. *Andalusian Diplomatic Relations with Western Europe during the Umayyad Period (A.H. 138–366/A.D. 755–976): an Historical Survey*, orig. Ph.D. thesis, Cambridge University, U.K., 1966; Beirut, Dar al-Irshad, 1970. 333 pp.; ill.; maps; facsimis; Bibl.: pp. [299]–321.

The book, largely based on primary Arabic sources, examines the Moorish diplomatic relations under the Umayyads with Christian Spain, the Franks, the Vikings, the Germans, and the Italians.

79. Harvey, Leonard P. *Islamic Spain. 1250 TO 1500*, Chicago/London, Chicago University Press, 1990. xiv, 370 pp.; map; Bibl. refs.: pp. 341-359; Index.

Focusses both on the Moors in Al-Andalus and under Christian rulers, with attention also being given to the Moorish contribution to the making of the early Modern World.

80. Hell, Joseph. *The Arab Civilization*, transl. from the German by S. Khuda Bukhsh. Cambridge, Heffer, 1926, xvii, 128 pp. "Literature": pp. 122–124; 2nd ed., Lahore, Pakistan, S.M. Ashraf, 1948. xx, 140 pp. Bibl.: [133]–136.

81. Hitchcock, Richard, "Muslim Spain (711–1492)," in Peter E. Russell, ed., *Spain, a companion to Spanish Studies*, London, 1973, pp.41–63; For full bibliographical details, see below, no. 135.

82. Hitti, Philip K. *History of the Arabs from the Earliest Times to the Present*, New York, MacMillan, 1951.; 10th ed., London, MacMillan/New York, St. Martin Press, 1970. xxiv, 822 pp.; ill.; Geneal. Tables; Bibl. refs.; Index.

Part IV (Chapters 34–42) covers "The Arabs in Europe: Spain and Sicily." An indepth study.

See also entry no. 378 below.

83. Hitti, Philip K. *The Arabs. A Short History*, New York, St. Martin's

- Press, 1968. 5th ed., viii, 211 pp.; Condensation of *History of Arabs*, maps; 1970. 2nd rev. pbk. ed.
- A concise overview of the history of the Arabs that includes many references to Moorish Spain.
84. Hitti, Philip K. *The Makers of Arab History*, New York, St. Martin's Press, 1968. 268 pp.; maps; bibl. refs.; Index.
- An introduction to representative leaders in the fields of Islamic religion, political history and culture. Chapters include "Abd-al-Rahman I: Maker of History on European Soil," "Ibn Rushd: The Great Commentator," and "Ibn Khaldun: the First Philosopher of History".
85. Hodgson, Marshall G.S. *The Venture of Islam. Conscience and History in a World Civilization*, Chicago, University of Chicago Press, 1974. 3 vols.; Bibliographies & Indexes.
- Vol. 1: The Classical Age of Islam.* 532 pp.
- Vol. 2: The Expansion of Islam in the Middle Periods.* 609 pp
- Vol. 3: Gunpowder Empires and Modern Times.* 469 pp.
86. Hole, Edwyn. *Andalus: Spain under the Muslims*, London, R. Hale, 1958. 189 pp.; ill.; Bibl.: pp. 182–183; Index.
- A somewhat popular approach. Themes include history, people, administration, poetry, and slavery. Nothing on scientific and philosophical achievements. Contains a brief treatment of the Almoravide and the Almohad dynasties.
87. Holt, P.M., Lambton, A.K.S., and Lewis, B., eds., *Cambridge History of Islam*, 2 vols. Cambridge, U.K., Cambridge University Press, 1970. Ill., maps., includes bibliographies. 1977 ed. 2 vols in 4: Vol. 2A: Includes Africa and the Muslim West; Vol. 2B: Islamic Society and Civilization.
- Vol. 2A: xvi, 439 pp.: Part VII. Africa and the Muslim West: Ch. 1: Roger Le Tourneau, "North Africa to the Sixteenth Century," pp. 211–237; Ch. 7: Ambroxio Huici Miranda, "The Iberian Peninsula and Sicily," pp. 406–439.
- The chapters comprise overviews of the political history of the regions.
- Vol. 2B: xx, 966 pp. Ill.; Dynastic List (Umayyads of Spain); Glossary; Bibl.: 891–905; Index. See also Gabrieli, Francesco, no. 374 below.
88. Hopkins, J.F.P., "The Almohade Hierarchy," *Bulletin of the School of Oriental and African Studies* (London), XVI (1954), 93–112.
89. Hourani, Albert. *A History of the Arab Peoples*, London, Faber & Faber/Cambridge, Mass., Belknap Press of Harvard University Press, 1991. xx, 551 pp. ill., maps. Bibl. refs.: pp.500–529; Index.
- The most up-to-date history of the Arab peoples and Islamic civilization, with due attention also being given to cultural matters.

90. Imamuddin, S. M. "Cordova Muslim Rule in Iqritish [Crete]," *Journ. Pak. Hist. Soc.*, 8 (1960), 296–312.
91. Imamuddin, S. M. *Some Aspects of the Socio-Economic and Cultural History of Muslim Spain 711–1492*, Medieval Iberian Peninsula: Texts and Studies, vol. 2, Leiden, E.J. Brill, 1965. 238 pp; 15 pp. of photos; with 1 folding leaf. Appendix A: Important Dates: pp. 201–6; Bibl. [207]–214; Index.
- A Pakistani scholar's detailed survey of the field, based on both primary and secondary sources, that, unfortunately, lacks analytical rigor.
92. Imamuddin, S.M. *A Political History of Muslim Spain*, Dacca, Naymagh Sons, 1969, rev. ed. xiv, 394 pp., orig. publ. 1961.; Ill.; Genealog. Tables, maps, Bibl. [386]–394.
- A rather unbalanced survey of the political developments in Moorish Spain, 711–1492. Of the 19 chapters, 14 deal with the period 711–1091. The Almoravid and the Almohad dynasties are covered in a single short chapter, while the Nasrid dynasty is devoted a full separate chapter.
93. Irving, Thomas B. *Falcon of Spain; a study of eighth-century Spain, with special emphasis upon the life of the Umayyad Ruler Abdurrahman I (756–788)*, Lahore, Pakistan, Sh. M. Ashraf, 1962. 2nd ed. viii, 203 pp.; Ill.; Bibl.: pp. 200–203.
94. Irving, Washington (1783–1859). *Journal of Washington Irving, 1828 and miscellaneous notes on Moorish legend and history*; edited by Stanley T. Williams, New York, American Book Company, 1937. xv, 80 pp., plates, map.
95. Irving, Washington. *Chronicle of the Conquest of Granada*, Philadelphia, Carey, Lea & Cary, 1829; Boston, Twayne Publishers, 1988. Introduction by Earl N. Harbert, text edited by Miriam J. Shillingsburg (The Complete Works of Washington Irving, v. 13); xxi, 441 pp.
- Irving's romantic account of the Fall of Granada elicited high praise from his British contemporaries like Byron, Coleridge, Dickens, Scott, Southey, and Thackeray.
96. Irving, Washington. *The Alhambra: a series of tales and sketches of the Moors and Spaniards*, with an introduction by Elizabeth R. Pennell; illustrated with drawings of the places mentioned by Joseph Pennell, London, Darf Publishers, 1986. Reprint of the 1896 ed. Orig. publ. in Philadelphia, 1832. xx, 436 pp.; Ill.
- The author worked for the US embassy in Spain in the 1820s when his interest in the Moors was first kindled. Irving's evocative narrative — part imaginative, part scholarly — and gripping style aroused much romantic interest in Moorish Spain at the time, especially in Europe.
- On the Alhambra, see also Calvert, A.F., no. 50 above and

- Bargebuhr, Frederick P., no. 243 below.
97. Jackson, Gabriel. *The Making of Medieval Spain*, London, Thames & Hudson/New York, Harcourt Brace Jovanovich, 1972. 216 pp. Ill (some col.); facsim. Geneal. Tables, maps; Bibl.: pp. 198-201; Index.
98. Jackson, John G. *Introduction to African Civilizations*, Introduction and additional Bibliographical Notes by John H. Clarke, New York, University Books, 1970; Secaucus, N.J., Citadel Press, 1980. 384 pp.; Ill. Bibliographies: pp. 351-373; Index.
- The chapter on "The Civilizing of Europe: The Moors in Spain," pp. 157-195, includes an Appendix with Illustrations.
- Unlike most studies on the Moors, Jackson, veteran African American scholar, stresses the African component of Moorish history and culture. Much direct quotation from secondary sources.
99. Jackson, John G. *Man, God and Civilization*, Secaucus, N.J., Citadel Press, 1972. 327; Bibl.: pp. 309-320; Index. Chapter XVI entitled "The Evolution of Civilization: The Arab-Moorish Culture," pp. 263-282, stresses the Africanness of Moorish culture and history.
100. Julien, Charles-André. *History of North Africa*, transl. from the French by John Petrie and edited by C.C. Stewart, London, Routledge, Kegan Paul/New York, Praeger, 1970. xvi, 446 pp.; maps, plans; Glossary; Bibl.: 351-421. French original: *Histoire de L'Afrique du Nord*, Paris, Payot, 1952.
- The emphasis is on political developments but cultural matters are also given attention. Extensive coverage of the Almoravide and Almohad dynasties, also in Moorish Spain.
101. Karenga, Maulana. *Introduction to Black Studies*, Los Angeles, University of Sankore Press, 1982. xv, 376 pp.; Bibliographies; No Index.
- As part of the African historical background, the author provides a segment on "The Moorish Empire in Spain," (pp. 63-65) which particularly stresses the cultural contributions of the Moors and their impact on Europe.
102. Lane-Poole, Stanley (1854-1931). *The Story of the Moors in Spain*, New York, 1886; 1911; New reprint with an introduction by John G. Jackson, Baltimore, MD, Black Classic Press, 1990; distrib. also Trenton, N.J., Africa World Press. xx, 285 pp.; 111.; maps.
- According to the *Guide to Islam* by David Ede *et al* (see above, no. 07), Lane Poole's book is largely a "popular summary of R. Dozy's *Histoire des Musulmanes d'Espagne*" (p. 28). For Dozy, see entry no. 67 above. The 1990 reprint features on the striking cover a tall impressive-looking Moorish gentleman, resplendent in colorful robes.
- Jackson's Introduction consists mainly of long excerpts from secondary sources.
- Lane-Poole, the British Arabic scholar, paints a very positive picture

- of the Moors in Spain. However, the author, who is certainly pro-Arab (more in an ethnic than a cultural sense), nonetheless exhibits a peculiar ambivalence with regard to the true identity of the Moors. He gives the following definition of the term "Moor": "The word Moor is conveniently used to signify Arabs and other Mohammedans in Spain, but properly it should only be applied to *Berbers* of North Africa and Spain." And he continues somewhat enigmatically: "In this volume the term is used in its common acceptation, unless the Arabs are specially distinguished from the Berbers." (1990 edition, p. 13n) However, he is unable to contain his anti-African sentiment (the book first appeared at the time of the so-called "Scramble for Africa," that is, at the height of modern European imperialism. Twice, for example, he refers to the Berbers as "barbarians" (pp. 102, 175).
103. Lane-Poole, Stanley. *The Mohammedan Dynasties. Chronological and Genealogical Tables with Historical Introductions*, London, Constable, 1894/New York, Frederick Ungar, 1965. xviii, 361 pp.; Index of Rulers; Orig. publ. 1893. Includes North Africa and Moorish Spain.
104. Lapidus, Ira M. *Muslim Cities in the Later Middle Ages*, Cambridge, Mass., Harvard University Press, 1967. Student Ed., Cambridge, U.K./New Ork, Cambridge University Press, 1984. xvi, 208 pp.; Bibl.: pp. 192-197; Index.
105. Laroui, 'Abdull-ah. *The History of the Maghrib, an Interpretative Essay*, trans. from the French by Ralph Manheim, Princeton, Princeton University Press, 1977. vii, 431 pp.; maps; Appendix; Bibl.: 401-422; Index. French original: *L'Histoire du Maghreb* (Paris, 1970).
- Extensive discussion of the Almoravide and Almohad movements and dynasties in North Africa and Spain.
106. Latham, John D. *From Muslim Spain to Barbary: Studies in the History and Culture of the Muslim West*, London, Variorum Reprint, 1986. 348 pp., Ill., maps; Bibl. refs.; Index.
107. Lea, Henry C. *The Moriscos of Spain: their Conversion and Expulsion*, Philadelphia, Lea Brothers & Co., 1901. xii, 463 pp.; Appendix of Original Documents; Bibl. Notes; Index.
- An indepth treatment of the theme. However, the author is not free of anti-African bias: the coming to Spain of the Almoravids and the Almohads is for instance described as the "irruption of fresh hordes of fanatic barbarians" (p. 1).
- On the Moriscos, see also Chejne, Anwar G., no. 55, Monroe, James T., no. 125, and Gayangos, P. de. no. 251.
108. Le Tourneau, R. *The Almohad Movement in North Africa in the Twelfth and Thirteenth Centuries*, (Princeton Studies on the Near East), Princeton, Princeton, Princeton University Press, 1969. viii, 127 pp. "Sources": pp. 115-121. The text comprises three lectures in which the

- author gives an historical survey of the rise and fall of the Almohads.
109. Lévi-Provençal, Evariste (1894–1956). *Islam d'Occident: études d'histoire médiévale* (Islam d'hier et d'aujourd'hui, v. 7), Paris, Maisonneuve, 1948. xxv, 320 pp.; Bibl. refs.
110. Lévi-Provençal. *Histoire de L'Espagne Musulmane*, 2nd. ed. 3 vols., Paris, G. P. Maisonneuve 1950–1953. A new and revised edition. Ill.; plates; maps; Geneal. Tables; Bibliographies.
- The first three volumes of a planned general history of Moorish Spain that, however, remained incomplete at the author's death in 1956.
- The narrative goes up to 1031. The published volumes contain valuable bibliographical references.
111. Lévi-Provençal. *La Civilisation Arabe en Espagne; vue générale*, 3rd ed., Paris, G.P. Maisonneuve et Larose, 1961; 205 pp.; Bibl.: 166–174; chron. tables: pp. 175–205 (Islam d'hier et d'aujourd'hui, v.1).
- For other entries by Lévi-Provençal, see nos. 183 and 184 below.
112. Lewis, Archibald R. *Naval Power and Trade in the Mediterranean, A.D. 500–1100* (Princeton Studies in History, 5), Princeton, Princeton University Press, 1951. xii, 271 pp; maps; Bibl. refs.
- Includes many references to Moorish Spain.
113. Lewis, Archibald R., ed. *The Islamic World and the West, A.D. 622–1492* (Major Issues in History), New York, Wiley, 1970. xvi, 146 pp.
- A general historical survey of the relations between the Islamic territories and peoples and Europe at the time.
114. Lewis, Bernard. *The Arabs in History*, London, Hutchinson, 1954. 200 pp.; maps; Bibl.: pp. 184–194; rev. ed. New York, Harper & Row (Harper Torchbook Edition), 1967.
- Includes Chapter VII: "The Arabs in Europe".
115. Lewis, Bernard, ed., *Islam and the Arab World: faith, people, culture*, New York, Knopf, in assoc. with American Heritage Publ. Co., 1976. 360 pp. ill. (some col.); facsimis; maps 31 cm., Bibl.: 349–350; Index.
- Includes G. Gomez, "Moorish Spain."
- For the chapter on Moorish science, see Sabra, A.I., no. 349 below.
116. Lewis, Bernard. *The Muslim Discovery of Europe*, New York, W.W. Norton, 1982. 350 pp.; Ill.; Bibl. notes; Index.
- Contains various references to Moorish Spain.
117. Livermore, Harold V. *The Origins of Spain and Portugal*, London, Allen & Unwin, 1971. 438 pp; Bibl.: pp. 397–428; Index. Part III is entitled "The Muslim Invasions" and covers the history of the Moors in the Iberian Peninsula (Al-Andalus).
118. Lomax, Derek W. *The Reconquest of Spain*, London/New York, Longman, 1978. xvi, 212 pp., ill.; Bibl. refs.; Index.
- The Christian reconquest of Spain was completed with the fall of

- Granada in 1492.
119. Lopez, Robert, *The Birth of Europe*, London/New York, M. Evans, 1967. xxiii, 442 p. ill. maps; plans; Bibl.: pp. 403–406.
120. Mackay, Angus, *Spain in the Middle Ages: from Frontier to Empire, 1000–1500*, (New Studies In Medieval History), New York, St. Martin's Press, 1977. xii, 245 pp. ill.; Bibl. [213]–229; Index.
121. al-Masumi, M. Saghir Hasan, "The earliest Muslim Invasion of Spain," *Islamic Studies* (Karachi), III (1964), 97–102.
122. McCabe, Joseph (1867–1955). *Splendour of Moorish Spain*, London, Watts and Co., 1935. xiii, 298 pp. Ill.; No Bibl.; Index.
- The Foreword refers to earlier writers on Moorish Spain.
- The text itself contains only an occasional bibliographical reference.
- An enthusiastic treatment of the history of the Moors in Spain by a former British Catholic priest who became a famous freethinker, stressing particularly the Moorish cultural achievements in contrast to conditions in benighted Christian Europe at the time. However, the book suffers from a serious anti-African bias. The Moorish achievements are primarily attributed to Arabs (in an ethnic sense) and Jews. In a Chapter entitled "The Real Moors of Spain," McCabe claims that the Moors ("the 'Dark' Men") or Berbers "had no affinity with the negroes—it is a ridiculous stage-tradition that makes Othello a black man—and were mainly Arabs or other Semites who had wandered across Northern Africa before the days of the Romans, and had settled on the land between the Mediterranean and the mountains." (p. 137)
123. Meakin, Budgett (1866–1906). *The Land of the Moors. A Comprehensive Description*, London, Sonnenschein/New York, MacMillan, 1902; reprint: London, Darf, 1986. xxii, 503 pp.; ill., map.
124. Meyerson, Mark D., *The Muslims of Valencia in the Age of Fernando and Isabel: between co-existence and crusade*, Berkeley, University of California Press, c. 1991. xi, 372 pp., maps, Bibl. refs.: pp. 351–361; Index.
125. Monroe, James T. "A Curious Morisco Appeal to the Ottoman Empire," *Al-Andalus*, 31 (1966), 281–303.
- On the Moriscos, see also Chejne, Anwar, no. 55, Lea, Henry C., no. 107, and Gayangos, P. de, no. 251.
126. Munis, Husayn (Hussain Mones). "Los Almoravides," *Revista del Instituto de Estudios Islamicos (RIEI)*, Madrid, 15 (1967–1968), 49–102.
127. Murphy, Francis X. "Julian of Toledo and the fall of the Visigothic kingdom in Spain," *Speculum*, 27 (1952), 1–27.
- The Visigothic kingdom in Spain was overthrown by the Moors in 711.
128. Niane, D.T., ed. *Unesco General History of Africa. vol. IV: Africa from*

the Twelfth to the Sixteenth Century, Paris/ Unesco/London/Heinemann/Berkeley, California Un. Press, 1984. xxv, 751 pp.; Ill.; maps; Bibl.: pp. 692–733; Index. Chapters 3–7 deal with the Maghrib and Moorish Spain. Bibl. refs.; Bibliography.

One of the few books that provide an Africa-centered perspective on the Moors in North Africa and Spain. See also El Fasi, ed., no. 71 above.

129. Norris, H.T. "The early Islamic settlement in Gibraltar," *Journal of the Royal Anthropological Institute of Great Britain*, 91 (1961), 39–51.

Moorish rule in Gibraltar lasted from 711 to 1462. For an explanation of the origin of the name Gibraltar, see the annotation to the entry under Chandler, Wayne B., no. 52 above.

130. O'Callaghan, Joseph F. *A History of Medieval Spain*, Ithaca/London, Cornell University Press, 1975. 729 pp.; 4 leaves of plates; maps; Bibl.: pp. 683–705; Index.

The book deals with the political history of Spain, with due attention also given to economic and cultural matters. As in the works of Lane-Poole, McCabe and others, an almost obligatory anti-African bias is also found here: for example, the Almoravids are described as "barbarian nomads" (p.208).

131. Powell, James M., ed. *Muslims under Latin Rule 1100–1300*, Princeton, N.J., Princeton University Press, 1990. 221 pp.; Bibl. refs.; Index.

A collection of essays dealing with Muslim minorities under Christian rule, in Portugal, Castille, etc.

132. Read, Jan. *The Moors in Spain and Portugal*, Totowa, N.J., Rowman and Littlefield, 1975. 268 pp.; [8] leaves of pls.; ill.; maps; Comparative Chronology: pp. 240–248; Bibl.: pp. 249–255; Index.

A readable political and cultural history of the Moorish presence in the Iberian Peninsula.

See also the entry under Read, Jan, no. 389 below.

133. Reinaud, Joseph T. (1795–1867). *Muslim colonies in France, northern Italy, and Switzerland*, transl. by Haroon Khan Sherwani, 2nd rev. ed., Lahore, Sh. Muhammad Ashraf, 1964. xii, 258 pp [1] leaf of plates, fold. map., Bibl. refs., Index. French original: 1836.

134. Risler, Jacques C. *La Civilisation Arabe*, Paris, Payot (Petite Bibliothèque Payot), 1955. 248 pp. Table of Contents, pp. 245–248. No Notes. No Bibliography.

A brief overview of Arabic civilization and its influence on Europe, with many references to Moorish Spain.

135. Russell, Peter E., ed. *Spain, a companion to Spanish Studies* (University Paperbacks, 571), London, Methuen 1976. New ed., xv, 592 pp.; fold. plate; geneal. tables; col. map; Bibliographies; Index.

Chapter on Muslim Spain by Richard Hitchcock; see no. 81.

136. Saab, Hasan. "Communication between Christianity and Islam," *Middle East Journal* (Washington, D.C.), 18 (1964), 41–62.

137. Sánchez-Albornoz, Claudio. *El Islam de Espana y el Occidente* (Colección Austral, no. 1560), Madrid, Espasa-Calpe, 1974. 224 pp.; Bibl. refs.; no Index.

138. Saunders, John J. (1910–1972). *A History of Medieval Islam*, London/New York, Routledge, Kegan and Paul, 1965. xv, 219 pp.; maps; Bibliographies.

139. Scott, Samuel P. (1846–1929), *History of the Moorish Empire in Europe*, Philadelphia/London, J.B. Lippincott, 1904. 3 vols. "Authorities Consulted": vol. 1, pp. xvii–xlii, Ill.; New York, AMS Press, 1977. 3 vols. Reprint of 1904 ed.; Index.

140. Setton, Kenneth M., gen. ed. *A History of the Crusades*, 2 vols. 2nd ed., Madison, Wis., University of Wisconsin Press, 1969. Ill.; col. maps.

141. Sordo, Enrique, *Moorish Spain: Cordova, Seville, Granada*. Photographs by Wim Swaan. Transl. by Ian Michael, New York, Crown Publishers/London, Elek Books, 1963. 223 pp. Ill.; geneal. tables; plans; charts; glossary; Bibl.: p. 220; Index.

Gives a political history of the cities and their respective achievements in the arts, especially architecture. The greater part of the book is devoted to Granada, the center of the last Moorish dynasty which fell in 1492.

142. Spuler, Bertold. *The Muslim World: A Historical Survey*. Translated from the German by F.C.C. Bagley. 3 vols., Leiden, Brill, 1960–1969.

Vol. 1: vii, 138 pp.; Dynastic Tables; Bibl.: pp. 120–128; maps; Indexes; Chapter V: "Spain."

The chapter provides a brief survey of the political and cultural history of Moorish Spain.

143. Stern, Samuel M. (1920–1969). *History and Culture in the Medieval Muslim World*, London, Variorum Reprints, 1984. xi, 344 pp.; Bibl. refs. and Index.

A collection of previously published articles that contain various references to Moorish Spain.

144. Szarmach, Paul E., ed., *Aspects of Jewish culture in the Middle Ages: papers of the eight annual conference of the Center for Medieval and Early Renaissance Studies, State University at Binghamton, 3–5 May, 1974*, Albany, State University of New York Press, 1979. xxi, 208 pp; Ill. Jewish scholars like Maimonides, who wrote in Arabic, played a prominent role in the intellectual life of Spain under the Moors.

For entries on Maimonides, see nos. 227–229 below.

145. Taha, 'Abd al-Wahid Dhannun. *The Muslim Conquest and Settlement of North Africa and Spain* (Exeter Arabic and Islamic series), London/New York, Routledge, c 1989. xiv, 280 pp. Bibl.: pp. 254–263; Index.

146. Van Sertima, Ivan, ed. *African Presence in Early Europe*, New Brunswick, N.J./Oxford, U.K., Transaction Books, 1985/*Journal of African Civilizations*, November 1985, vol. 7, no. 2). 317 pp.; Ill.; maps; Bibl. refs.; No Index.

In a chapter entitled "The African Presence in Early Europe: The Definitional Problem," the editor examines the evidence for a pre-Moorish African presence in Spain and discusses the various definitions of terms like "Moors," "Berbers" and "Arabs" in relation to North African and Spanish history.

For further comments on the Moors by Van Sertima, see the "Introduction", pp. 7–16. For brief references to the Moors, see also Edward Scobie, "The Black in Western Europe", pp. 190–202, and Beatrice Lumpkin and Siham Zitzler, "Cairo: Science Academy of the Middle Ages," pp. 176–189.

Two other relevant chapters appear in this Bibliography as separate entries: see Chandler, Wayne B., no. 52 and Johnson, Rosalind, no. 380.

147. Vicens Vives, Jaime. *An Economic History of Spain*, with the collaboration of Jorge Nadal Oller, translated by Frances M. Lopez-Morillas, Princeton, Princeton University Press, 1969. viii, 825 pp. Ill. & maps; Bibl.: pp. 747–802; Index.
148. Von Grunebaum, Gustav E. (1909–1972). *Medieval Islam: A Study in Cultural Orientation*, Chicago, University of Chicago Press, 1946; 2nd ed. 1953. vii, 365 pp.; maps.; Bibl. refs.; Index; Phoenix Books Edition: 1962, vii, 378 pp.
149. Von Grunebaum, Gustav E., ed. *Unity and Variety in Muslim Civilization* (Comparative Studies of Cultures and Civilizations, No. 7), Chicago, Chicago University Press, 1955, 1963. xii, 385 pp.; Ill.; map; Bibl. refs.

For a relevant chapter see under Abel, Armand, no. 31.

150. Von Grunebaum, Gustav E. *Classical Islam. A History 600–1258*, transl. by Katherine Watson, London, Allen & Unwin, 1970. Ill.; maps; Chron. tables; Bibl.: pp. 211–221; Index. German original: 1963.

Contains a special chapter on the Islamic West.

151. Wasserstein, David. *The Rise and Fall of Party-Kings: Politics and Society in Islamic Spain 1002–1086*, Princeton, Princeton University Press, 1985. xiii, 338 pp; Bibl. pp. 297–327; Index.

A history of Moorish Spain in the period between the fall of the Umayyads and the coming of the Almoravids.

152. Watt, William M., with Pierre Cachia. *A History of Islamic Spain* (Islamic Surveys, 4), Edinburgh, Edinburgh University Press, 1965. x, 210 pp.; 16 pls.; Bibl.: pp. 186–191; Index.

A readable introduction to the political and cultural history of

Moorish Spain.

153. Whisham, Bernard (1857–1914) and Ellen M. *Arabic Spain; sidelights on her history and art*, London, J. Murray, 1912/London, Darf, 1986. xv, 421 pp., Illus.; genealogical tables; Bibl.: [xiii–xv].

Deals mainly with the history of Seville under the Moors.

154. Wolf, Kenneth B., *Christian Martyrs in Muslim Spain*, Cambridge, U.K./New York, Cambridge University Press, 1988. xi, 147 pp.; Bibl.: 141–145 pp.; Index.

The book seeks to investigate the motives of the group of ninth-century Christian martyrs in Cordova who deliberately provoked the Moorish authorities, and those of their contemporary apologist, the Catholic priest, Elogius.

Review:

155. Brodman, James W. *American Historical Review*, Vol. 94 (October 1989), 1084.

On these Christians martyrs, see also Colbert, Edward P. no. 158 below.

156. Yonge, Charlotte M. (1823–1901). *The Story of Christians and Moors in Spain*, London, MacMillan, 1879. xvi, 299 pp. ill.

Criticism:

See Van Sertima, Ivan, ed., no. 146 above. According to Van Sertima, the author, like other writers on Moorish Spain, denies that the Berbers have any "indigenous African element in their composition". However, in describing one battle against Christians in Spain, Yonge writes that "there was a frightful slaughter of the Africans" (p. 175). "One wonders," comments Van Sertima tellingly, "how they could have been practically *non-existent* in life and have such a great presence in death" (Van Sertima, Ivan, ed., no. 146 above, p. 141).

C. Historiography and Primary Sources

157. Barnes, Harry E. *A History of Historical Writing*. 2nd Revised ed., New York, Dover, 1963. Orig. pub. 1937. xiii, 450 pp. Bibliographies; portrait; Index.

Chapter IV. "Historical Writing During the Middle Ages" contains a brief overview of Islamic historiography, with special attention given to Ibn Khaldun who, according to Barnes, "completely outdistanced any Christian historian in his fundamental grasp of the principles of human and cultural development" (p. 94).

On Ibn Khaldun, see below, nos. 163–179.

158. Colbert, Edward P. *The Martyrs of Cordoba (850–859). A study of the sources*, Washington, D.C., Catholic University of Marica Press, 1962. xi, 491 pp. Bibl.: pp. 454–468.

On these martyrs, see also Wolf, Kenneth B., No. 154, and Brodman, James W., no. 155 above.

159. Goldhizer, I. "Materialen zur Kenntniss der Almohaden-Bewegung," *Zeitschrift der deutschen morgenländischen Gesellschaft*, XLI (1887), 30–140.

Discusses sources for the history of the Almohad movement.

160. Highfield, John Roger Londale, compiler & editor, *Spain in the fifteenth century, 1369–1516: essays and extracts by historians of Spain*, tr. [fr. the Spanish] by Frances M. Lopez-Morillas, London, MacMillan, 1972. 488 pp.; maps; Bibl.

Ibn 'Abd al-Hakam (d. 870/871)

161. Ibn 'Abd al-Hakam, d. 870 or 871. *The History of the Conquest of Spain*. Translated and edited by John Harris Jones, New York, B. Franklin, 1969. (Selected Essays in History, Economics, and Social Science, 80). vi, 81, 38 pp.; Bibl. refs.; Orig. publ. 1858.

After the Preface and Historical Introduction follow the English Translation, Exegetical Notes, and finally the Arabic text.

Ibn Hayyan, Abu Marwan (987–1075)

162. Goldman, S., "Ibn Hayyan and his Place in Spanish-Moslim Historiography," *Transactions of the Glasgow University Oriental Society*, VII (1934–35), 1–4.

Ibn Khaldun, 'Abd al-Rahman (1332–1406)

163. Ibn Khaldun. *The Muqaddimah, an introduction to history*, transl. from the Arabic by Franz Rosenthal, New York, Pantheon Books, 1958. 3 vols.; plates, col. maps (1 fold.) diags., facsim. (part col.) (Bolligen series, 43); Sel. Bibl.: vol. 3, pp. [483]–512 by Walter J. Fischel. Transl. of author's Introduction (Muqaddimah) to his *Kitab al-'Ibar*.

The foremost twentieth-century British historian, Arnold J. Toynbee (1889–1975) who, in the first volume of his monumental *A Study of History* (1934), denied that Africa had produced any civilization other than the Egyptian (characterized as "white"), described Ibn Khaldun's *The Muqaddimah* as "a philosophy of history which is undoubtedly the greatest work of its kind that has ever yet been created by any mind in any time or place." (*A Study of History*, London/New York, Oxford University Press, 1934, Vol. 3, p. 322.

Reviews:

164. *Ann. Am. Acad.*, 3 (1959).

165. *Library Journ.*, 1 Dec., 1958.

166. *Mid. East Journ.*, Sum. 1959.

167. *Times Lit. Sup.* (London), 18 Dec., 1959.

168. Ibn Khaldun. *The Muqaddimah, an introduction to history etc.*, 2nd ed., with corrections and augmented bibl.; Princeton, Princeton University Press, 1967. 3 vols. ill. Bibl. vol. 3: pp. [483]–521; Indexes.

169. Ibn Khaldun. *An Arab Philosophy of history: Selections from the Prolegomena of Ibn Khaldun of Tunis (1332–1406)*. Translated and selected by Charles Issawi. Princeton, The Darwin Press, 1987. xiv, 192 pp.; Bibl.: pp. 182–184; Index.

170. Ibn Khaldun. *Histoire de Berbères et des dynasties musulmanes de l'Afrique septentrionale*; trans. of Ibn Khaldun's *Kitab al 'Ibar.*, edited and translated by W. McGuckin de Slane, 4 vols., Algiers, 1852–1856; new ed., Paris, Geuthner, 1969 (repr. of 1925–56 rev. ed.).

Criticism:

171. 'Azmah, 'Aziz. *Ibn Khaldun in Modern Scholarship: a Study in Orientalism*, London (Third World Centre for Research and Publishing), 1981. xxi, 333 pp.; Bibl.: [229]–318; Indexes.

Part IV of the book comprises an extensive systematic Bibliography.

172. 'Azmah, 'Aziz. *Ibn Khaldun, an essay in reinterpretation*, London/Totowa, N.J., Cass, 1982. xv, 176 pp.; Bibl. refs.; Index.

173. Baali, Fuad, *Society, State, and Urbanism. Ibn Khaldun's Sociological Thought*, Albany, State University of New York Press, 1988. xi, 175 pp. Notes; Bibl.: pp. 157–167, includes works in Arabic; Index.

Through a comparative analysis, the author shows that Ibn Khaldun's ideas about society and historical change preceded not only those of Machiavelli, Vico, Turgot but also those of Montesquieu, Comte, Durkheim, Marx, Gumpłowicz, Spengler, and Tönnies.

174. Baali, Fuad and Wardi, Ali. *Ibn Khaldun and Islamic Thought Styles: a social perspective*, Boston, Mass., G.K. Hall, 1981. xii, 155 pp.; Bibl.: pp. 141–148; Index.

A study in the sociology of knowledge.

175. Ennan, Muhammad Abdullah. *Ibn Khaldun, his life and work*, Lahore (India), Sh. M. Ashraf, 1946. vi, 144 pp.; Bibl.: pp. 142–144. Translated from the Arabic.

176. Lacoste, Yves. *Ibn Khaldun: the birth of history and the past of the Third World*, London, Verso, 1984. 214 pp.; Bibl. refs.; Index. French original: Paris, 1966; Spanish transl.: Barcelona, 1971; Arabic transl.: Beirut, 1977.

177. Mahdi, Muhsin, *Ibn Khaldun's Philosophy of History: a study in the philosophic foundations of the science of culture*, London, Allen & Unwin, 1957; [Phoenix Books Edition], Chicago, University of Chicago Press, 1964. 325 pp.; Bibl.: pp. 297–310; Index.

Review:

178. *Times Lit. Suppl.*, 2 May, 1958, pp. 244–245.
179. Megherbi, Abdelghani. *Ibn Khaldoun, sa vie et son oeuvre*, (Series: Pour Tous), 2nd ed., Algiers, S.N.E.D., 1980. 43 pp. No Bibl. No Index. 1st published: 1970.
A very general overview of Khaldun's life and works, from a sociological perspective.
180. Imamuddin, S.M. "Sources of Muslim History of Spain," *Journal of the Pakistan Historical Society*, I (1953), 357–79.
Leo Africanus [Leo the African], also known as al-Hasam ibn Muhammad al Wazzan al-Zayyati al-Gharnati (b. ca. 1485–d. ca. 1554):
181. Leo Africanus. *A Geographical Historie of Africa*, transl. by John Pory, London, 1600; facs. ed. Amsterdam/New York, 1969; reedited by Robert Brown under the new title: *The History and Description of Africa*, London, Hakluyt Society, 1896; New York, Burt Franklin, 1963; 3 vols.; maps. (1st series, nos. 92–94). Italian original: Venice, 1550.
See also Johnson, Rosalind on the parallels between the life of Leo Africanus and Shakespeare's character Othello, no. 380 below.
- Criticism:*
182. Mauny, R., "Note sur *Les grands voyages de Léon l'Africain*," *Hespéris*, XLI (1954), 379–394.
183. Lévi-Provençal, Evariste. *Documents inédits d'histoire almohade, fragments manuscrits du "legajo" 1919 du fonds arabe de l'Escorial*, Paris, Geuthner, 1928. xii, 276, [156] pp.; maps
Introduction, Translation and Notes.
184. Lévi-Provençal, Evariste, ed. *Majmu rasail muwahhidiyah: trente-sept lettres officielles almohades*, Rabat, Publications de l'Institut des hautes études marocaines, 10, 1941.
Arabic text edited by Lévi-Provençal.
For other entries by Lévi-Provençal, see 109–111. above.
185. Lewis, Bernard & Holt, Peter M., eds., *Historians of the Middle East*, University of London. School of Oriental and African Studies. Historical Writings of the Peoples of Asia, vol. 4. Oxford, Clarendon Press, London/New York, Oxford University Press, 1962.
Since the books also encompass African and Spanish Moorish authors, the series is clearly misnamed. Otherwise a valuable resource for Islamic historiography.
186. Makki, Mahmud 'Ali, "Egipto y los orígenes de la historiografía árabo-española," *Revista del Inst. de Estudios Islámicos* (Madrid), V. (1957), 157–248.

al-Maqqari [al-Makkari], Abu 'l-'Abbas Ahmad b. Muhammad. (d. 1631/32)

187. al-Maqqari. *The history of the Mohammedan dynasties in Spain*, translated from the copies in the library of the British Museum, and illustrated with critical notes on the history, geography, and antiquities of Spain by Pascual Gayangos, London, Oriental Translation Fund of Great Britain and Ireland, London, W.H. Allen, 1840, 1843, 2 vols. London/New York, 1964, reprint of 1843 London ed.; New reprint: Delhi (Idarah-i Adabiyat-i Delli (IAD) religion-philosophy reprint series, no. 38), 1984.
Translation of *Nafh al-Tib min Ghusn al-Andalus al-Ratib...*
188. Margoliouth, David S. (1858–1940). *Lectures on Arabic Historians*, Calcutta, The University of Calcutta, 1930; (Burt Franklin: Research and Source Works series. Byzantine series: 38) Reprint of 1930 ed.; New York, Burt Franklin, 1972. 160 pp. No. Bibl.; No. Index.
The book comprises lectures that were delivered before the University of Calcutta, February 1929.
189. Monroe, James T. *Islam and Arabs in Spanish Scholarship (Sixteenth Century to the Present)*. Leiden, Brill, 1970. (Medieval Iberian Peninsula. Texts and Studies, vol. 3). x, 297 pp. Bibl.: pp. [271]–291.
A useful critical study of the differing assessments of the Moorish period in Spanish scholarship. However, the comments are not confined to Spanish writers: Washington Irving, Dozy, Lévi-Provençal and other writers on Moorish Spain also feature in the discussions.
190. Rosenthal, Franz. *A History of Muslim Historiography*, Leiden, Brill, 1952, vii, 558 pp.; Bibl. refs.; 2nd rev. ed., 1968; xvi, 656 pp.; Bibl. refs.
A guide to historical writings in the Muslim world.
- Review:*
191. Sarton, George, *Isis*, 44 (1953), 78–79.
192. Sánchez-Albornoz, Claudio, ed. *La España musulmana según los autores islámicos y cristianos medievales*. 2 vols. 2nd ed., Buenos Aires, El Ateneo, 1960. 1st pub.: 1946.; maps, (part. fold.); illus. (part. col.); Bibl. refs.; 3rd ed., Madrid, Espasa-Calpe, 1973.
The book comprises excerpts from original Moorish and Christian writers, with accompanying commentary.
- Criticism:*
See Monroe, James T. no. 189 above.
193. Sauvaget, Jean (1901–1950), *Historiens Arabes: pages choisies. tr. et présentées par Jean Sauvaget* (Initiation à L'Islam, 5), A. Maisonneuve, 1946. 192 pp.

D. Philosophy and Theology

I. Bibliographies, Etc.

194. Anawati, George C. "Bibliographie de la philosophie médiévale en terre d'Islam pour les années 1959–1969," *Bull. Phil. Médiév.*, 10–12 (1968–1970), 316–369.
195. Calverley, E. "A brief bibliography of Arabic philosophy," *The Muslim World*, XXXII (1942), 60–68.
196. *The Encyclopedia of Religion*. Editor-In-Chief, Mircea Eliade, Vol. 7., New York, MacMillan/London, Collier MacMillan, 1987. Relevant articles: Abdallah Laroui, "Islam in North Africa," pp. 322–336; Hanna E. Kassis, "Islam in Spain," pp. 336–344; map; Bibliographies.
Contains good brief overviews of the history of the religious, legal and philosophical ideas of North Africa and Moorish Spain.
197. Gutmann, James, ed. *Philosophy A to Z* (Universal Reference Library), New York, Grosset & Dunlap, 1963. viii, 343 pp. Bibl.: 313–322 pp.; Index.
The articles on Jewish Philosophy and Islamic Philosophy are adaptations from those that appear in Radhakrishnan, ed. *History of Philosophy, Eastern and Western* (1953). Averroës and Maimonides are discussed.
See also below, no. 232.
198. *The Philosopher's Index. An International Index to Philosophical Periodicals and Books* (1967/68). Bowling Green, OH, Philosophy Documentation Center, Bowling Green State University.
The Center also issues annual cumulative editions and retrospective indexes.
199. Plott, John C. and Mays, Paul D. *Sarva-Darsava-Sangraha. a Bibliographical Guide to the Global History of Philosophy*, Leiden, Brill, 1969. xix, 305 pp. Index.
Moorish philosophers are considered under "Islam". The two Synchronological Charts exclude Africa as a geographical region altogether. North African and Moorish philosophers in Spain are illogically grouped under "Central and Southwest Asia."
See also Plott, John C., no 231 below.
200. Sheikh, M. Saeed. *A Dictionary of Muslim Philosophy*, Lahore, Institute of Islamic Culture, 1976.

II. Other Works

201. Ali, Ameer [Maulani Saiy'd] (1848–1929), *The Spirit of Islam: a history of the evolution and ideals of Islam, with a life of the prophet,*

New York, Humanities Press, 1974. lxxi, 515 pp; facsim.; Bibl.: p. 513–514; Index.

Reprint of the 1922 amplified and revised ed., London, Chatto & Windus, 1978. 1st publ. 1873.

202. Anawati, Georges C. "Philosophy, Theology, and Mysticism," in Schacht and Bosworth, eds., *The Legacy of Islam* (2nd ed. 1974, 1979), pp. 350–391; Bibl.: [389]–390.
For full bibliographical details, see no. 394 below.

Averroës, see under Ibn Rushd

203. Badawi, 'Abd R. *Histoire de la Philosophie en Islam*, Paris, Vrin, 1972. 2 vols.
204. De Boer, Tjitze. *History of Philosophy in Islam*, transl. [from the German] by E.R. Jones, London, Luzac, 1903. Reprinted 1961. xiii, 216 pp. No Bibl. refs.; no Bibl.; only a brief acknowledgment of sources in the Preface; Index. 2nd. ed., New York, Dover, 1933. 229 pp; Reissue, 1961. Reprint: New Delhi, Cosmo Publishers, 1983. Arabic translation.: Muhammad 'Abd al-Hadi (Cairo, 1957).
The author, a Dutch scholar, concludes his history with Ibn Khaldun (1332–1406). Chapter VI: "Philosophy in the West" deals with Moorish philosophers (Ibn Bajja, Ibn Tufayl, Ibn Rushd), while the final chapter discusses Ibn Khaldun and "The Arabs and Scholasticism".
205. Fakhry, Majid. *A History of Islamic Philosophy* (Studies in Oriental Culture, 5). 2nd ed., New York, Columbia University Press, 1987. 394 pp.; Bibl.: 368–375; Index.
The Moorish philosophers discussed include Al-Suhrawardi, Ibn 'Arabi, Ibn Bajjah, Ibn Hazm, Ibn Khaldun, Ibn Masarra, Ibn Rushd, and Ibn Tufayl.
206. Guillaume, Alfred, "Philosophy and Theology," in Arnold and Guillaume, eds., *The Legacy of Islam* (1st ed. 1931), pp. 239–283; Bibl.: p. 283.
For full bibliographical details, see no. 364 below.
207. Haines, Charles R. *Christianity and Islam in Spain, A.D. 756–1031*, London, Kegan, Paul & Trench, 1889; 2nd ed., New York, AMS Pres, 1972. viii, 182 pp.; Bibl.: pp. [175]–182.
208. Hourani, George F., ed. *Essays on Islamic Philosophy and Science*, (Studies in Islamic Philosophy and Science) Albany, State University of New York Press, 1975. viii, 261 pp.; Includes Bibl. refs. and Glossary.
209. Hyman, Arthur & Walsh, James J., eds., *Philosophy in the Middle Ages: The Christian, Islamic, and Jewish Traditions*, New York, Hackett, 1983. 805 pp. 2nd rev. ed. vii, 747 pp.; Bibl.: [723]–728; Index.

Ibn 'Arabi, Muhiyy al-Din (1165–1240)

210. Ibn 'Arabi. *The Besels of Wisdom [Fusus al-hikam]* and introduction by R.W.J. Austin; pref. by Titus Burckhardt (Classics of Western Spirituality), New York, Paulist Press, 1980. xviii, 302 pp.; Bibl.: 285-287 pp. Index.
211. Ibn 'Arabi. *Sufis of Andalusia: The "Ruh al-quds" and "al-Durat al-fakhirah"* of Ibn 'Arabi; translated with introduction and notes by R.W.J. Austin; with a foreword by Martin Lings, London, Allen & Unwin, 1971.
Criticism:
212. Affifi, Abu E., *The Mystical Philosophy of Muhyid Din Ibnul 'Arabi*, London, Cambridge University Press, 1939; Lahore, M. Ashraf, 1964. xx, 213 pp.; diagrams.
213. Corbin, Henry. *Creative Imagination in the Sufism of Ibn 'Arabi'*, transl. from the French by Ralph Manheim (Bollingen series, 91), Princeton, Princeton University Press, 1969. vii, 406 pp.; Ill. (part. col.); Bibl.: 393–398 pp.: Index.
214. Landau, Rom. *The Philosophy of Ibn 'Arabi* (Ethical and Religious Classics East and West, no. 22), London, Allen & Unwin, 1959. 126 pp.
Contains a selection from *Tarjuman al-Ashwaq*, pp. 91–122.
On Ibn 'Arabi, see also Nasr, Seyyed H., no. 230 below.

Ibn Hazm, 'Ali Ibn Ahmad (994–1064 or 1068)

215. Ibn Hazm, *The Ring of the Dove, a Treatise on the Art and Practice of Arab Love*, transl. by A.J. Arberry, London, Luzac, 1953. 228 pp.
Criticism:
216. Chejne, Anwar G. *Ibn Hazm*, Chicago, Kazi, c. 1982. viii, 340 pp. Added t.p. In Arabic; Bibl.: pp. 314–326; Index.
217. Nykl, A.R., "Ibn Hazm's 'Treatise on Ethics,'" *Am. Journ. Sem. Lang. & Lit.*, 40 (1923), 30–36.

Ibn Khaldun. For his Philosophy of History, see above under Section C: Historiography.

Ibn Massarraah (d. 931)

218. Asin Palacios, Miguel (1871–1944). *The Mystical Philosophy of Ibn Massara and his followers*, transl. [from Spanish] by Elmer H. Douglas and Howard W. Yoder, Leiden, Brill, 1978. xii, 204 pp.; Bibl.: pp. 184–190 Index. Spanish original: Madrid, 1914.

Ibn Rushd, Abul-Walid Mohammed (Averroës) (1126–1198): Moorish Spain's foremost philosopher, Ibn Rushd or Averroës, greatly influenced the development of European philosophy.

219. Ibn Rushd. *Averroës' Three short commentaries on Aristotle's "Topics," "Rhetoric" and "Poetics,"* edited and transl. by Charles E. Butterworth (Studies in Islamic Philosophy and Science), Albany, State Uni. of New York Press, 1977. xi, 206 pp.; Bibl. refs.; Index.
Text in Arabic and English.
220. Ibn Rushd. *Averroës on Plato's Republic*. Translated, with an introduction and notes by Ralph Lerner, Ithaca, NY, Cornell University Press, 1974. xxix, 176 pp.; Bibl.: pp. 163–166; Index.
221. Ibn Rushd. *Tahafut al-Tahafut* ("The Incoherence of Incoherence") transl. by Simon van den Bergh, London, Luzac, 1954. 2 vols. (E.J.W. Gibb Memorial Series. New Series, 19) [Unesco Collection of Great Works. Arabic Series]. Vol. 1: Introduction, Translation; Vol. 2: Notes. Bibl. refs.; Index.
222. Ibn Rushd. *On the Harmony of Religion and Philosophy*. A transl. with Introd. and Notes by George F. Hourani, London, Luzac, 1961. 128 pp. (Gibb Memorial Series. New Series, 21) [Unesco Collection of Great Works. Arabic Series]. Original: *Kitab fasl al-maqal*, with its appendix (*Damima*) and an extract from *Kitab al-kashf 'an manahij al-adilla*.
Criticism:
223. Leaman, Oliver, *Averroës and His Philosophy*, Oxford, Clarendon Press/New York, Oxford University Press, 1988. xii, 240 pp.; Bibl.: pp. 197–201. Index.

Ibn Tufayl, (also spelled Tufail, Tufail etc.) (1106–1185)

224. *Ibn Tufayl's Hayy Ibn Yaqzan: a philosophical tale*, translated with introd. and notes by Lenn E. Goodman, (Library of Classical Arabic Literature, Vol. 1), New York, Twayne, 1972. ix, 246 pp. Includes bibl. refs. Translation of *Hayy Ibn Yaqzan* ["Alive, Son of the Awake"].
225. Leaman, Oliver. *Introduction to medieval Islamic Philosophy*, Cambridge, U.K./New York, Cambridge University Press, 1985. xii, 208 pp. Indexes.
226. Lerner, Ralph and Mahdi, M. eds. *Medieval Political Philosophy; a sourcebook* (Agora Editions), Glencoe, Ill, Free Press of Glencoe, 1963. xii, 532 pp.; Bibl.: 527–528 pp.; Index.

Maimonides, Moses [Musa Ibn Maymun/Moses ben Maimon] (1135–1204) *Maimonides, a contemporary of Ibn Rushd (Averroës), was Moorish Spain's foremost Jewish philosopher. He wrote mostly in Arabic.*

227. Maimonides. *Guide to the Perplexed*. Translated with an Introduction and Notes by Shlomo Pines; with an introductory essay by Leo Strauss. Chicago, University of Chicago Press, 1963. cxxxiv, 658 pp. Bibl. Refs. Translation from the Arabic and Hebrew versions.

228. Maimonides. *A Maimonides Reader*, edited, with introduction and notes by Isadore Twersky (Library of Jewish Studies), New York, Behrman House, 1972. xvii, 494 pp.; Bibl.: pp. 483–490; Index.

Criticism:

229. Pines, Shlomo and Yovel, Yirmiyahu, eds. *Maimonides and Philosophy: Papers presented at the Sixth Jerusalem Philosophical Encounter, May 1985* (International Archives of the History of Ideas, 114), Dordrecht, The Netherlands, Nijhoff, 1986. ix, 286 pp.; Bibl. refs.: Index.

230. Nasr, Seyyed H. *Three Muslim Sages, Avicenna-Suhrawardi-Ibn 'Arabi*, (Harvard Studies in World Religions), Cambridge, Mass. Harvard University Press, 1964; Delmas, NY, Caravan Books, 1976. 185 pp; Index; Bibl.: pp. 125-129.

The book comprises open lectures that were delivered at Harvard University in March 1962. Chapter III deals with "Ibn 'Arabi and the Sufis".

On Ibn 'Arabi, see also above, nos. 210–214.

231. Plott, John C., with Dolin, James M. and Mays, Paul M. *Global History of Philosophy. IV. The Period of Scholasticism (Part One)*, Delhi, Motilal Banarsidass, 1984. xvi, 690 pp. Bibliographical refs. in Notes.

Contains a Typological Chart of Islamic Philosophers. Discusses Ibn Gabirol, the Jewish philosopher, and Ibn Hazm, the two contemporaries in eleventh-century Moorish Spain.

See also later volumes.

See also Plott, John C. no. 199 above.

232. Rhadakrishnan, ed., *History of Philosophy Eastern and Western*. 2 vols. London, Allen & Unwin, 1952–53. Vol. II, pp. 462. Bibliographies; Index. Ch. 23: "Islamic Philosophy" by R. Walzer, pp. 120–148. Sel. Bibl. pp 146–148.

Upon its first appearance in 1952, this was no doubt a pioneering work in its break with a prevalent Eurocentric approach to philosophy. However, the emphasis in this Indian collaborative work is heavily on India (East; 3 of the 4 parts of Vol. 1 deal with Indian philosophy) and Europe (West). There is neither a special category Africa nor (ancient) Egypt.

Walzer discusses the general background to Islamic philosophy and deals briefly with philosophers like Avicenna and Averroës.

See also Gutman, no. 197 above.

233. Rosenthal, Erwin I.J. "La filosofía política en la España musulmana," *Revista de Occidente*, 78 (1969), 259–280.

234. Rosenthal, Erwin I.J. *Political Thought in Medieval Islam; an introductory outline*, Cambridge, Cambridge University Press, 1962. xi, pp. 323; Bibl. refs. included in "Notes": pp. 234–306. Index. 1st pub. 1958.

235. Rosenthal, Franz, *Knowledge Triumphant. The concept of knowledge in medieval Islam*, Leiden, Brill, 1970. viii, 358 pp.; Bibl. refs.

Themes discussed include education, philosophy, Sufism and theology.

236. Scharfstein, Ben-Ami et al. *Philosophy East/Philosophy West: a critical comparison of Indian, Chinese, Islamic and European philosophy*, London/New York, Oxford University Press, 1978. viii, 359 pp.; Bibl.: 331–350; Index.

237. Sharif, M.M., ed., *A History of Muslim Philosophy*. 2 vols., Wiesbaden, Otto Harrassowitz, 1963–1966. Vol. 2: viii, 789-1792 pp. Bibliographies; Index.

A survey of Islamic intellectual history in all its diverse facets, including scientific thought. One chapter discusses the "Influence of Muslim Thought on the West".

238. Sheikh, M. Saeed. *Islamic Philosophy*, London, Octagon Press, 1982. x, 174 pp. Bibl.: 152–162; Index. (First published as *Studies in Muslim Philosophy*, Lahore, Pakistan Philosophical Congress, 1962).

Contains separate chapters on Sufism, Ibn Bajjah (Avenpace), Ibn Tufayl, Ibn Rushd (Averroës), and Ibn Khaldun.

239. Watt, William M., *Islamic Philosophy and Theology* (Islamic Surveys, 1), Edinburgh, Edinburgh University Press, dist. Chicago, Aldine Publishing Co., 1962. 2nd ed., Edinburgh, Edinburgh University Press, 1985: vii, 175 pp.; Bibl.: 164–166; Index.

Traces the development of the main Islamic intellectual and theological ideas up to the 19th century.

E. Literature and the Arts

I. Bibliographies Etc.

240. Creswell, Keppel A.C. (1879–1974). *A Bibliography of the Architecture, Arts and Crafts of Islam to 1st January 1960*, Cairo, 1961. xxiv, 1330, xxv pp. 35 cm.; 2nd ed.: Vaduz, American University in Cairo, Quarto Press, 1978. The most extensive bibliography on the subject.

Moorish Spain is extensively covered.

241. Creswell, Keppel A.C. *A Bibliography of the Architecture, Arts and crafts of Islam. Supplement, Jan. 1960 to Jan. 1972*, [Cairo], American University in Cairo Press, 1973. xii, 366 columns, ix ; Index; 35 cm.

II. Other Works

242. Arberry, Arthur J. (1905–1969), compiler. *Aspects of Islamic Civilization as Depicted in the Original Texts*. New York, A.S. Barnes, 1964; London, Allen & Unwin, 1964.; (Ann Arbor Paperbacks, AA 130), Ann Arbor, University of Michigan Press, 1967. 409 pp.

A personal choice of literature (not just imaginative writing), translated by the compiler himself.

243. Bargebuhr, Frederick P., *The Alhambra: a cycle of studies on the eleventh century in Moorish Spain*, Berlin, De Gruyter, 1968. xvi, 438 pp. Ill., map., Bibl. refs.: Index.

On the Alhambra, see also Calvert, Albert F., no. 50 and Irving, Washington, no. 96. above.

244. Briggs, M.S., "Architecture," in T. Arnold and A. Guillaume, eds., *The Legacy of Islam*, (1st ed., 1931), pp. 155–179. Bibl.

See also Chapter VI "Art and Architecture" in Schacht & Bosworth, *The Legacy of Islam*, (2nd ed., 1974/1979), pp. 244–319. Includes Bibliographies.

For full bibliographical details, see no. 364 (First ed.) and no. 364 (2nd ed.).

245. Brockelman, Carl (1868–1956). *Geschichte der Arabische Literatur*. 2 vols. and 3 supplements, Weimar, Verlag von Emil Felber and Leiden, Brill, 1898–1942. Includes Bibliographical references and Indexes.

Discusses literature in the widest sense, that is, including works in history, philosophy and science.

246. Cantarino, Vincent. "Lyrical Traditions in Andalusian Muwashshahas," *Comparative Literature*, 21 (1968), no. 3, 213–231.

Muwashshahas were a popular form of Moorish strophic poetry that appeared in the tenth century and flourished especially under the Almoravid dynasty.

247. Chejne, Anwar G. *The Arabic Language: Its Role In History*, Minneapolis, University of Minnesota Press, 1969. x, 240 pp.; 4 plates; Bibl.: pp. 207–228.

248. Creswell, Keppel A.C. *Early Muslim Architecture*, With a contribution by Marguerite Gautier-Van Berchem. 2nd ed., Oxford, Clarendon Press, 1969. Ill. (some col.), facsim., plans. Includes bibliographies.

249. Creswell, Keppel A.C. *A Short Account of Early Muslim Architecture*, Harmondsworth, Middlesex, U.K., Penguin Books (Pelican Books A

- 407), 1958, xiv, 330 pp. ill., plates.

Deals in detail with the Great Mosque of Cordova.

250. Farris, Nabih A. and Hitti, Philip K. *et al.*, eds. *The Arab Heritage*, New York, Russell & Russell, 1963. x, 279 pp. ill; Bibliographies; Index. 1st pub. Princeton, Princeton University Press, 1944.

Based on a series of special lectures given at Princeton University. The chapters include references to the literature, scientific thought, and art of Moorish Spain.

251. Gayangos, P. de, "Language and Literature of the Moriscos," *British and Foreign Review*, 8 (1839), 63–95.

On the Moriscos, see also Chejne, Anwar G., no. 55, Lea, Henry L., no. 107, and Monroe, James T., no. 125 below.

252. Gibb, Hamilton A. R. (1895–1971). *Arabic Literature, an Introduction*, London, Oxford University Press, 1926; 2nd rev. ed., Oxford, Clarendon Press, 1963; (Oxford Paperbacks, 332) London/New York, Oxford University Press, 1974. iii–xi, 182 pp., Bibl.: [163]–173.; Index.

Contains special sections on Moorish Spain.

253. Goldstein, David, ed. *The Jewish Poets of Spain 900–1200*, translated with an introduction and notes (The Penguin Classics), Harmondsworth, Middlesex, U.K., Penguin Books, 1971. Rev. and expanded ed.; 218 pp.; Bibl.: pp. 23–26. Previously published as *Hebrew Poems from Spain* (London, 1965).

254. Jeffery, Arthur, ed. *A Reader on Islam; passages from standard Arabic writings illustrative of the beliefs and practices of Muslims*, The Hague, Mouton, 1962. 678 pp.; Bibl. refs. New York, Books for Libraries, 1980. Reprint of 1962 ed.

The excerpts include "The Credal Statement" of Ibn Tumart (founder of the Almohad movement), and al-'Arabi's "Instructions to a Postulant".

255. Kritzack, James, ed. *Anthology of Islamic Literature. From the Rise of Islam to Modern Times*. New York, New American Library (Meridian Books), 1964. 379 pp.; Bibl.: 378–379.

Includes a selection of Moorish Poetry (pp. 141–146), and excerpts from non-fiction works by Ibn Battutah, Ibn Hazm, Ibn Khaldun, and Ibn Tufayl.

256. McNeill, William H. and Marilyn R. Waldman, eds. *The Islamic World, Readings in World History*, vol. 6, Oxford, New York, Oxford University Press, 1977. xvii, 468 pp. ill.; Bibl. refs.

257. Miles, George C., *The Coinage of the Umayyads in Spain* (Hispanic Numismatic series, monograph, no. 1), New York, The American Numismatic Society, 1950. xi, 591 pp., plates.

258. Monroe, James T., compiler. *Hispano-Arabic Poetry: A Student Anthology*, Berkeley, University of California Press, 1974. xviii, 402 pp.

Bibl.: pp 395–402

Includes poems in Arabic with English translations.

259. Nicholson, Reynold A. (1868–1945). *A Literary History of the Arabs*, Cambridge, U.K., Cambridge University Press, 1930; 2nd ed., 1941; 1962, xxxi, 506 pp. Bibl. (European Languages): 477–486; Index.

Chapter IX: "The Arabs in Europe" covers the literature of Moorish Spain.

260. Nykl, Alois R., ed. *Selections from Hispano-Arabic Poetry*, Beirut, 1949.
261. Rice, David T. *Islamic Art* (Praeger World of Art series), New York, Praeger, 1965. Rev. ed., New York, Oxford University Press, c 1975. 288 pp.; Ill., some col. facsimis; maps, plans. ports. Bibl.: pp. 261–263; Index.
262. Rivoira, Giovanni T. (1849–1919), *Moslem Architecture: Its Origin and Development*. Transl. from the Italian by Gordon M.N. Rushforth London, Oxford University Press, 1918. xvii, 383 pp. Includes plates, ill., plans, ports.; New York, Hacker Arts Books, 1975.
263. Rosenthal, Franz. *The Classical Heritage in Islam*, transl. from the German by Emile and Jenny Marmorstein (Islamic World series), Berkeley, University of California Press, 1975. xx, 298 pp. Bibl. refs.; Index.

Contains excerpts from various sources.

264. Said, Ibn. *Moorish Poetry: A Translation of the Pennants; an Anthology Compiled in 1243*, transl. by A. J. Arberry, Cambridge, Cambridge University Press, 1953. xx, 199 pp. Indexes.
265. Terrasse, Henri, *L'Art Hispano-Mauresque des Origines au XIII Siècle* (Publications de l'Institut des hautes études marocaines, t. xxv). Paris, G. van Oest, 1932. 506 pp. xvi, 506 pp.; ill.; 70 plates; plans; Bibl.: pp. 475–481.
266. Ullah, Najib, *Islamic Literature. An Introductory History with Selections*, New York, Washington Square Press, 1963. xxi, 441 pp. Sel. Readings (Bibl.), pp. 429–431; Index. Also covers historical, scientific and philosophical writings.

F. The Natural Sciences

I. Bibliographies and Periodicals

267. *Current Work in the History of Medicine; an International Bibliography*, London, Wellcome Institute for the History of Medicine (1954–1975).
268. *Dictionary of Scientific Biography*, editor-in-chief: Charles C. Gillespie, New York, Scribner, 1970–1980. Bibliographies; Indexes,

Contains good brief biographies of the most important Moorish scientists, with bibliographies.

269. Ebied, Rifaat Y. *Bibliography of Mediaeval Arabic and Jewish Medicine and Allied Sciences* (Wellcome Institute for the History of Medicine Publications, Occasional Series 2), London, Wellcome Institute for the History of Medicine, 1971. 150 pp; 1972 entries, books and articles; Indexes.

Review:

270. Savage-Smith, Emilie. *Isis*, 63 (1972), 274–275.
271. Hamarneh, Sami K. *Bibliography on Medicine and Pharmacy in Medieval Islam*, introduced by Rudolf Schmitz (Veröffentlichungen der Internationalen Gesellschaft für Geschichte der Pharmazie, no. 25), Stuttgart, Wissenschaftliche Verlagsgesellschaft, 1964. 4 tables; 204 pp. Annotated.
272. Historical Association, U.K., *The Early History of Science. A Short Handlist*, London, George Philip for the Historical Association, 1950.
A partially annotated bibliography of the global history of science that contains a section on Islamic Science.
273. *Isis; international review devoted to the history of science and civilization*, Brussels/ Bern/ Cambridge, Mass. Vol. 1 (1913 –).
The review was founded by George Sarton and serves as an indispensable resource for the global history of science.
See also *Isis Cumulative Bibliographies*, nos. 274–280 below.
274. *Isis Cumulative Bibliography. A Bibliography of the History of Science formed from ISIS Critical Bibliographies 1–90 1913–65. Vol. 1: Part I: Personalities A–J*, edited by Magda Whitrow. London, Mansell & History of Science Society, 1971. lxxviii, 664 pp.
275. *Isis Cumulative Bibliography. A Bibliography of the History of Science formed from ISIS Critical Bibliographies 1–90 1913–65. Vol. 2: Part I: Personalities K–Z: Part II: Institutions*, edited by Magda Whitrow. London, Mansell & History of Science Society, 1971. 789 pp.
276. *Isis Cumulative Bibliography. A Bibliography of the History of Science formed from ISIS Critical Bibliographies 1–90 1913–65. Vol. 3: Subjects*, London, Mansell & History of Science Society, 1976. xciv, 678 pp.; Index.
277. *Isis Cumulative Bibliography. A Bibliography of the History of Science formed from ISIS Critical Bibliographies 1–90. 1913–65, Vol. 4: Civilizations and Periods, Prehistory to Middle Ages*, edited by Magda Whitrow, London, Mansell etc. in conjunction with the History of Science Society, 1982. xviii, 457 pp.
278. *Isis Cumulative Bibliography 1966–1975. A Bibliography of the History of Science formed from ISIS Critical Bibliographies. 91–100 indexing literature published from 1965 through 1974*. Edited by John

Neu. London, Mansell & History of Science Society, 1980. *Vol. 1: Personalities and Institutions*. xxix, 483 pp.

279. *Isis Cumulative Bibliography 1976–1985*, edited by John Neu, with Peter G. Sobol. A Bibliography of the History of Science formed from the *Isis Critical Bibliographies* 101–110 indexing literature published from 1975 through 1984, Vol. 1: Persons and Institutions, Boston, Mass, G.K. Hall & Co., 1989. xxiv, 587 pp. (Author) Index.
280. *Isis Cumulative Bibliography 1976–1985*, edited by John Neu, with Peter G. Sobol. A Bibliography of the History of Science formed from the *Isis Critical Bibliographies* 101–110 indexing literature published from 1975 through 1984, Vol. 2: Subjects, Periods and Civilizations, Boston, Mass, G.K. Hall & Co. xvi, 911 pp. Indexes.

All of the above *Isis Cumulative Bibliographies* contain items on science in Moorish Spain.

281. *Journal for the History of Arabic Science* (Aleppo, Syria, 1977 –).
282. Nasr, Seyyed H. and Chittick, William C. *An Annotated Bibliography of Islamic Science*. Vol. 1, Teheran, Imperial Iranian Academy of Philosophy, 1975. Also Lahore, Pakistan, Suhail Academy, 1985. 432 pp.; 2770 entries; Index. The Title, Contents and Introduction are also given in Persian at back after the Index.

This is the first volume in a projected series of 5. Most of the entries are not annotated. The annotations are also given in Persian. The book contains only works in European languages.

There is much duplication of entries.

Otherwise a useful resource.

Review:

283. Hall, Robert E. *Isis*, 69 (1978), 457–461.
284. Nasr, Seyyed H. and Chittick, William C. *An Annotated Bibliography of Islamic Science*. Vol. 2 (with Peter Ziris); Teheran, Imp. Iran. Acad. Philos. 1978 (Publ. 36). xxiii, 317 + 14 pp., 4341 entires; Index (of Writers). The Title, Contents and Introduction are also given in Persian at the back after the Index.

The second volume in the series.

285. Sarton, George. *Horus—A Guide to the History of Science*, Waltham, Mass. Chronica Botanica Co., 1952. xvii, 316 pp. Bibliographies of Islamic and Medieval Science appear in Section no. 17.
286. Savage-Smith, Emilie. "Islamic science and medicine," in Pietro Corsi & Paul Weindling, eds., *Information Sources in the History of Science and Medicine*, London/Boston, Butterworth Scientific, 1983 [Butterworth Guides to Information Sources], ch. 3. Critical bibliographical essay, pp. 437–448; Bibl.: pp. 448–455.

II. Other Works

Abu'l-Qasim al-Zahrawi (Albucasis) (936–1013)

287. Abu'l-Qasim. *Albucasis on surgery and instruments*. A definitive edition of the Arabic text with English trans. and commentary by M. S. Spink and G. L. Lewis. Berkeley, Univ. of California Press, 1973. xv, 850 pp.

The text is a translation of the 30th treatise of the *Kitab al-Tasrif*, an encyclopaedia of medicine and surgery. Al-Zahrawi, who greatly influenced the development of medicine and surgery, was known in medieval Europe as "the celebrated surgeon Albucasis".

Criticism:

288. Haddad, Farid Sami. "Zahrawi (936?–1013), the great Arab surgeon," *Atti XXI Cong. Int. Stor. Med.*, 1968, 2, 1600–1607.
289. Hamarneh, Sami H. *Drawings and pharmacy in al-Zahrawi's 10th-century surgical treatise* (Contributions from the Museum of History and Technology, Paper 22). Washington, DC, Smithsonian Institution, 1961 pp. 81–94; facsms., Ill.; Bibl. refs.

Deals with the surgery treatise *al-Tasrif*.

290. Hamarneh, Sami H. and Sonnedecker. A Pharmaceutical View of Abulcasis Moorish Spain, with special reference to "Adhan." (Janus Supplements, v. 5), Leiden, Brill, 1963; xii, 176 pp. ill. facsms. maps (1 fold); Bibl.: pp. [137]–157; Appendices; Index.

Revision of Hamarneh's Ph.D. thesis, University of Wisconsin, 1959.

On al-Zahrawi, see also Campbell, Donald E.H., no. 368 below.

291. Al-Hassan, Ahmad Y. and Hill, Donald R. *Islamic Technology: An Illustrated History*, Cambridge. U.K./London/New York, Cambridge University Press, 1987. xiv, 304 pp. Ill.; Bibl.; Index.
292. Arnaldez, R. & Massignon, L. "Arabic Science," in R. Taton, ed., *Vol. 1: Ancient and Medieval Science from the Beginnings to 1450*, transl. from the French by A. J. Pomerans, New York, Basic Books. pp. 385–421; Ill.; Select Bibl.: [p. 421].

An overview of the Islamic contributions to science up to 1450.

Averroës, see under Ibn Rushd

293. Bernal, John D. *Science in History. Vol. 1: The Emergence of Science*, Harmondsworth, Middlesex, UK, Penguin Books, 1969. 1st pub. London, Watts, 1954. 100 ill. Bibliographies.

Contains a brief general overview of Islamic science as part of the global history of science.

al-Bitruji al-Ishbili, Abu Ishaq (Alpetragius), (d. ca. 1204)

294. al-Bitruji, *On the Principles of Astronomy: an edition of the Arabic and Hebrew version with trans., analysis, and an Arabic-Hebrew-English Glossary by Bernard R. Goldstein. Vol. 1: Analysis and translation. Vol. 2: The Arabic and Hebrew versions.* (Yale Studies in the History of Science and Medicine, 7). New Haven, Yale University Press, 1971. Vol. 1: xii, 162 pp., Bibl. pp. 157–158; Index; vol. 2: x, 458 pp., Index.

On al-Bitruji and Copernicus, see Rosen, E., no. 390 below.

295. Browne, Edward G. (1862–1926). *Arabian Medicine* (St. Patrick Lectures delivered at the College of Physicians, 1919 and 1920). Cambridge, Cambridge University Press, 1921; reprinted 1962. Hyperion Reprint Edition, Westport, CT, Hyperion Press, 1983.; ix, 138 pp.; Ill.; Bibl. refs; Index.

A general survey.

296. Carra de Vaux, Baron, "Astronomy and Mathematics," in Arnold and Guillaume, eds., *The Legacy of Islam*, (1st ed. 1931), pp. 376–397.

For full bibliographical details, see no. 364 below.

297. Clagett, Marshall. *The Science of Mechanics in the Middle Ages* (University of Wisconsin. Publications in Medieval Science, 4), Madison, University of Wisconsin Press, 1959. xxix, 711 pp.; Ill., facsim.; Bibl.: pp 683–698; Index.

Contains brief references to Moorish scientists in Spain.

298. Crombie, A. C. *Medieval and Early Modern Science. Vol. I: Science in the Middle Ages: V–XIII Centuries*, Garden City, NY, Doubleday Anchor Books, 1959. xxii, 296 pp.; Ill.; Bibl.: 243–273; New rev. ed. 1st publ.: 1952, under the title *Augustine to Galileo: the history of science, A.D. 400–1650*.

Contains many references to Islamic science.

299. al-Daffa', Ali Abdullhah. *The Muslim Contribution to Mathematics*, London, Croom Helm /Atlantic Highlands, N.J., Humanities Press, 1977. 121 pp., Ill., Bibl., index.

300. Daumas, Maurice, ed., *A History of Technology and Invention: progress through the ages. Vol. 1: The Origins of Technological Civilization*, Transl. by Eileen B. Hennessy, New York, Crown Publishers, 1969. 596 pp.; Ill.; Bibliographies; Index. French original: 1962.

Ch. 12: "The Moslem World, seventh to thirteenth centuries," by Gaston Wiet. Bibl.

Also covers Moorish Spain.

301. Dreyer, John L.E. (1852–1926). *A History of Astronomy from Thales to Kepler*, 2nd ed., New York, Dover Publications, 1953. x, 438 pp.; Ill.; Bibl.: pp. [425]–429; Index.

302. Dunlop, Douglas M., *Arabic Science in the West*, Karachi, Pakistan Historical Society. Publication No. 35, 1958. v., 119 pp.; Bibl. refs.

303. Farrukh, Omar. *Arab Genius in Science and Philosophy*, transl. from the Arabic by John B. Hardie (Near Eastern Translation Program, 10), Washington, American Council of Learned Societies, 1954. xii, 161 pp. 1st publ. in Arabic in 1952.

304. Gille, Bertrand, "Technological Developments in Europe, 1100–1400," in Métraux and Grouzet, eds, *The Evolution of Science* (1963), pp. 168–219.

Includes brief references to Moorish Spain.

For full bibliographical details, see no. 326.

See also Millas-Vallicrosa, J.M., no. 333 below.

305. Goldstein, Thomas. *The Dawn of Modern Science: from the Arabs to Leonardo da Vinci*, Boston, Houghton Mifflin, 1980 xvii, 297 pp., Ill. Bibl.: 255–277 pp.; Indexes.

306. Haskins, Charles H. (1870–1937), *Studies in the History of Medieval Science*, F. Ungar, New York, 1960. xx, 411 pp.; reprint of 2nd ed., Cambridge, Harvard University Press, 1927.

See also Haskins, Charles H. nos. 307 and 377.

307. Haskins, Charles H. "Arabic Science in Western Europe," *Isis*, 7 (1925), 478–485.

308. al-Hassan, Ahmad Y. and Hill, Donald R., *Islamic Technology: An Illustrated History*. Cambridge, U.K., Cambridge University Press, 1986. xiv, 304 pp.; Ill.; Bibl.: pp. 287–295; Index.

309. Hourani, G., "The Early Growth of the Secular Sciences in Andalusia," *Studia Islamica*, 32 (1970), 143–156.

Ibn Bajjah [Avempace], (d. 1138)

310. Ibn Bajjah. *ʿIlm al-naḥs*, translation and notes by M.S.H. Ma'sumi, Karachi, 1961.

Translation based on the Bodleian ms. Pocock 206 (Oxford University, U.K.)

Criticism:

311. Moody, E.A., "Galileo and Avempace," *Journal of the History of Ideas*, XII, no. 2 (1951), 163–193; no. 3 (1951), 375–422.

312. Ziyadah, Ma'an. *The Theory of Motion in Ibn Bajjah's Philosophy*. *Diss. Abs. Int.* 1974, 34:6708–A. Dissertation at McGill Uni., 1973.

Ibn Battutah (1304–1377):

313. Ibn Battutah. *Tuhfat al-nuzzar fi ghara (The Gift of Observers or Travels)*. *The Travels of Ibn Battutah*, trans. H.A.R. Gibb, Cambridge, U.K.,

Cambridge University Press for the Hakluyt Society (Hakluyt Society, Works, 2nd series, no. 110), 1958, 1962, 1971. 2 vols.; Vol. 1., xviii, 272 pp.; Vol. 2, xii, 267 pp.; map (part. fold.).

Battutah, the fourteenth-century North African Moorish geographer and world traveller, visited Egypt, Arabia, Persia, India, China, and, after his return home to Morocco, crossed the Sahara and stayed in the West Sudanic empire of Mali (1350s). He also provides a contemporary description of Moorish Spain. It is estimated that Battutah must have traveled in all about 75,000 miles, which would be roughly the equivalent of going around the world three times at the latitude of the equator.

Reviews:

314. Pines, S. *Isis* 54 (1963), 503–507: rev. of Vol. 1.

315. Von Grunebaum, G. E. *Isis*, 54 (1963), 421: rev. of Vol. 2.

al-Idrisi, Abu 'Abdallah (1100–1166)

316. al-Idrisi. *Description de l'Afrique et de l'Espagne*, text and transl. by E. Dozy and M.J. de Goeje, Leiden, Brill, 1866; Amsterdam, Oriental Press, 1969. xxiii, 393, 242 pp.; reprint of 1866 ed.; Arabic text at end.

317. al-Imram, Abd Allah. "Andalusian Medicine: Theory and Practice," *Buletin de la Asociacion Espanola de Orientalistas*, vol. 23 (1987), 379–85.

318. Jachmowicz, Edith. "Islamic Cosmology," in Carmen Blacker & Michael Loewe, eds., *Ancient Cosmologies*, London, Allen & Unwin, 1975, Ch. 6, 143–171. Bibl. refs.: 168–171, Plates, Ill.

Provides an overview of Islamic cosmological ideas.

319. Kennedy, Edward S. "Survey of Islamic Astronomical Tables". *Transactions of the American Philosophical Society*, N.S. Vol. 46, Pt. 2, Philadelphia, American Philosophical Society, 1956, 123–177; Bibl.: pp. 174–175; Index.

320. King, David A. *Islamic Astronomical Instruments*, London, Variorum, 1987. 362 pp. Ill.; Bibl. refs.

A collection of previously published essays on Islamic astronomical instruments like the astrolabe, quadrant, compass, sundials, etc. Includes Ch. XV: "Three Sundials from Islamic Andalusia", pp. 358–392.

321. King, David A. "The Exact Sciences in Medieval Islam: Some Remarks on the Present State of Research," *Bulletin of the Middle East Studies Association*, 14 (1980), 10–26.

322. Kohn, M.A.R. "A Survey of Muslim Contributions to Science and Culture," *Islamic Culture*, XVI (1942), 1–20; 136–157.

323. Kunitzsch, Paul. "Two star tables from Muslim Spain," *Journ. Hist.*

Astron. 11 (1980), 192–201.

324. Mason, Stephen F. *A History of the Sciences*, New York, Collier Books (MacMillan), 1962; new rev. ed.; 1st publ. in 1956. Ch. 9: "Science and Technology in the Muslim World," pp. 95–102. Bibl., pp. 607–617.

Includes references to developments in Moorish Spain.

325. Mendelsohn, Everett, ed. *Transformation and Tradition in the Sciences. Essays in Honor of I. Bernard Cohen*, Cambridge, U.K./New York, Cambridge University Press, 1984. xi, 577 pp.; Bibl. refs.; Index.

Includes an essay on Moorish Science by Sabra, A. I.; see no. 350 below.

326. Métraux, Guy S. and Grouzet, François, eds., *The Evolution of Science* (Readings in the History of Mankind; selections from Unesco's *Journal of World History*), New York, New American Library of World Literature (Mentor Books: MQ 505), 1963. xxxi, 432 pp.; Ill.; Bibliographies.

The book comprises a collection of essays originally published in the *Journal of World History*.

For relevant entries on Moorish Spain, see Gille, Bertrand, no. 304 above, and Millas-Vallicrosa, J.M., no. 333 below.

327. Meyerhof, Max (1874–1945). "Science and Medicine," in Arnold & Guillaume, *Legacy of Islam*, (1st ed.; 1931), pp. 311–355.

For full bibliographical details, see below, no. 364.

328. Meyerhof, Max. "Esquisse d'histoire de la pharmacologie et botanique chez les musulmanes d'Espagne," *Al-Andalus*, vol. 3 (1935), 1–41.

329. Meyerhof, Max. *Studies in Medieval Arabic Medicine: theory practice*, edited by Penelope Johnstone, London, Variorum Reprints (Variorum Reprint: CS 204), 1984. xii, [366] pp.

A collection of reprints of previously published articles. The text is in English, French and Arabic.

330. Mieli, Aldo (1979–1950). *La Science Arabe et son role dans l'évolution scientifique mondiale*, Leyden, Brill, 1938. xix, 388 pp.; Bibl.

A general overview of the subject.

Review:

331. Sarton, George, *Isis*, 30 (1939), 291–295.

332. Mieli, Aldo. *La science arabe et son role dans l'évolution scientifique mondiale*, Réimpression anastatique, augmentée d'une bibliographie, avec index analytique, par A. Mazahéri, Leiden, Brill, 1966; xix, 467 pp.; Bibl.: pp. 391–461; 1110 entries.

Criticism:

See, for example, Nasr, Seyyed H., above no. 282, pp. 129–130. Nasr characterizes the work as "one of the best known general histories of Islamic sciences in Western languages" but states that because of "the author's lack of knowledge of Arabic the index to the first edition

is nearly useless."

333. Millas-Vallicrosa, J.M. "Translations of Oriental Scientific Works (to the End of the Thirteenth Century)" in Métraux & Grouzet, eds. *Evolution of Science*, pp. 128–167. Sel. Bibl.: pp. 166–167.

For full bibliographical details see no. 326 above. Sections include "Arab Culture as a Continuator and Integrator of the Scientific Culture of Alexandria," and "Arab and Christian Spain as a Cultural Meeting Point between Orient and Occident,"

See also Gille, Bertrand, no. 304.

334. Nasr, Seyyed H. *Science and Civilization in Islam. with a preface by Giorgio de Santillana*, Cambridge, Mass., Harvard University Press, 1968; 2nd ed. : Cambridge, U.K., The Islamic Texts Society, 1987. 388 pp.

Review:

335. Baumer, William H. "Islamic Science and its civilization," *Stud. Hist. Phil. Sci.* 2 (1971), 183–190. An Essay Review.

336. Eastwood, Bruce S. *Speculum*, XLV (1970), 150–153.

337. Nasr, Seyyed H. *Islamic Science. An Illustrated Study*. [London]/Westerham, Kent, U.K., World of Islam Festival Publishing Co., 1976. Photographs by Roland Michaud. xiv, 273 pp.; bibl. refs.; glossary; Sel. Bibl. in European languages: pp. 250–252. 135 plates; 94 figures; illus.: also in color.

The most extensive treatment of Islamic science available in English, including ample coverage of North Africa and Moorish Spain.

Reviews:

338. Hill, D.R., *Times Lit. Suppl.* (30 April, 1976), 510.

339. King, D.A., in *Journal for the History of Astronomy*, 9, (1978), 212–219; reprinted in *Bibliotheca Orientalis*, 35 (1978), 339–342.

This critical review only deals with the chapters on mathematics and astronomy in the book.

340. Lewis, G.L., *Nature*, 262 (1976), 239.

341. Savage-Smith, E., *Isis*, 69 (1978), 120–121.

342. O'Leary, De Lacy E. (1872–1957). *How Greek Science Passed to the Arabs*, London, Routledge, Kegan Paul, 1949; 1964: vi, 196 pp.; Bibl.: [189]–192; Index.

Review:

343. Gandiz, Solomon, *Isis*, 41 (1950), 125–127.

344. O'Leary, De Lacy E. "Arabic Science in Medieval Andalus," *Islamic Literature*, 9 (May 1957), 43–50.

345. Plessner, Martin, "The Natural sciences and medicine," in Schacht, J. and Bosworth, C.E., eds. *Legacy of Islam* (2nd ed., 1974), pp. 425–460; Bibl.: 459–460.

For full bibliographical details, see no. 394 below.

346. Ronan, Colin A. *The Cambridge Illustrated History of the World's Science*, Cambridge, U.K., New York, Cambridge University Press/Felton, Middlesex, U.K., Newnes Books, 1983. 543 pp. Ill.; Bibl.: 528–529; Index.

Chapter Five: "Arabic Science" (pp. 201–244) also deals with the development of science in North Africa and Moorish Spain.

347. Rosenthal, Franz. *The Classical Heritage in Islam*. Translated from the German by Emile and Jenny Marmorstein. (The Islamic World Series), London, Routledge & Kegan Paul, 1975. xx, 298 pp.; Bibl. refs.; Index. German original: 1965.

Contains various chapters on the sciences.

348. Qadir, C.A., *Philosophy and Science in the Islamic World: From the Origins to the Present Day*, London/New York, Helm, 1987. 218 pp.; Bibl. refs.; Index.

A rather general treatment of the themes, including references to philosophers and scientists in Moorish Spain.

349. Sabra, A. I. "The Scientific Enterprise: Islamic Contributions to the Development of Science," in Bernard Lewis, ed., *Islam and the Arab World: faith, people, culture*, London, 1976, pp. 181–200.

For full bibliographical details, see no. 115.

350. Sabra, A. I. "The Andalusian revolt against Ptolemaic astronomy: Averroes and al-Bitruji," in Everett Mendelsohn, ed., *Transformation and Tradition in the Sciences*, Cambridge, 1984, pp. 133–153.

For full bibliographical details, see above, no. 325. Averroës and al-Bitruji [Alpetragius] are both cited by Copernicus in his *On the Revolutions of the Heavenly Spheres* (1543). See annotation to entry no. 390 below.

351. Sarton, George (1884–1956). *Introduction to the History of Science*. 3 Volumes 5 parts. (Carnegie Institution of Washington. Publication, no. 376) Washington, DC, Carnegie Institution/Baltimore, Williams and Wilkins, 1927, 1931, 1947–1948.

The Belgian-born Sarton was the founding editor of *Isis*. See above nos. 273–280.

An indispensable resource for the scientific contributions of the Islamic world.

352. Savage-Smith, Emilie. "Gleanings from an Arabist's Workshop; Current Trends in the Study of Medieval Islamic Science and Medicine (Special section on Islamic Science and Medicine)", *Isis*, 89 (June 1988), 246–266.

This bibliographical essay comprises a useful survey of 43 books, catalogues, and articles on science in the medieval Islamic world.

353. Shahine, Y. A. *The Arab Contribution to Medicine* (University of Essex: The Fifth Carreras Arab lecture), Longman for the University of Essex,

1976. 52 pp. Text in both English and Arabic.

A very broad overview of the subject.

354. Singer, Charles J. (1876–1960), *From Magic to Science; essays on the scientific twilight*, London, E. Benn, 1928. xiv, 253 pp.; ill.; maps; plates (xiv col. incl. front.); diagrams; frontispiece and colored plates mounted.
355. Singer, Charles J. *et al.*, eds. *A History of Technology*, Oxford, Clarendon Press, 1954–1984. 7 volumes. Illus.; Vol. 2: *The Mediterranean Civilizations and the Middle Ages, c. 700 B.C. to c. A.D. 1500*. lix, 802; 44 plates; illus.; maps; Indexes.
356. Taton, Réne, ed., *History of Science. Ancient and Medieval Science from the Beginnings to 1450*. Translated [from the French] by A. J. Pomerans, New York, Basic Books, 1963. xx, 552 pp.; Ill.; Bibliographies; Indexes.
357. Ullmann, Manfred. *Islamic Medicine*, Translated by Jean Watt. (Islamic Surveys, 11) Edinburgh, Edinburgh University Press, 1978. xiv, 138 pp.; ill.; Bibl.: pp. 115–116; Index. German Original: Leiden, 1970.
358. Vernet, Juan. "Mathematics, astronomy, optics," in Schacht, and Bosworth, eds, *Legacy of Islam* (2nd ed., 1974), pp. 461–488; Bibl.: pp. 488–489.

For full bibliographical details, see no. 394 below.

359. Winter, H.J.J. *Eastern Science. An Outline of its Scope and Contribution* (Wisdom of the East Series), London, John Murray, 1952. Ch. 4: "The Scope of Arabic Science," pp. 59–90. Sel. Bibl.: pp. 101–106; Index.

Despite its misleading title, this slim book provides a valuable brief survey of the early scientific achievements of (North) Africans, the Moors in Spain and Asians.

360. Wright, O. "Music," in Schacht and Bosworth, eds. *Legacy of Islam* (2nd ed., 1974), pp. 489–504. Bibl.: p. 505.

For full bibliographical details, see no. 394 below.

al-Zarqali (Azarquiel), Abu Ishaq Ibrahim (d. 1100)

361. Boutelle, M., "The Almanac of Azarquiel," *Centaurus*, 12, no. 1 (1967), 12–19.
362. Vernet, J(uan), "Al-Zarqali," *Dictionary of Scientific Biography*, XIV (1976), 592–595.

For full bibliographical details, see no. 268 above.

G. The Impact of the Moors on Medieval Europe and the Modern World

363. Ahmad, Ziauddin. "The Rise of Islam and its Influence in Europe," *The Firmist Bond*, No. 26 (Summer 1987), 38–47.
364. Arnold, Sir Thomas W. (1864–1930) and Guillaume, Alfred., eds. *The Legacy of Islam*, London, Oxford University Press, 1931. 1st ed.; Reprint 1960; xvi, 416 pp. Ill., pls., maps; Bibliographies.

Has a special section on Spain and Portugal. Moorish Spain is also covered in all the other chapters.

For the second edition see, no. 394 below.

For some relevant chapters, see Guillaume, Alfred, no. 206, Carra de Vaux, Baron, no. 296, Meyerhof, Max, no. 327, and Christie, A.H., no. 369.

Review:

365. Thomson, William, *Speculum*, 7 (1932): 424–427.
366. Asín Palacios, Miguel (1871–1944). *Islam and the Divine Comedy*, translation [from the Spanish] by H. Sutherland, London, Cass, 1926; new impression: (Islam and the Muslim World, no. 4). London, Cass, 1968. xxv, 295 pp.; Bibl.: pp 278–287; Index. Spanish original: 1919.

Criticism:

See, for example, Chejne, Anwar G. (no. 54 above). Asín Palacios' book caused an uproar when it was first published in Spain in 1919, for it argued that Dante's *Divine Comedy* was modelled on Arabic literature, particularly the *Miraj*, a Muslim legend current at the time in Spain and Sicily.

367. Buckley, Siddiq, "Contributions of Islam to Europe in the Middle Ages," *Al Islam*, 3, 11 (November 1987), pp. 17–20.
368. Campbell, Donald E. H. *Arabian Medicine and Its Influence on the Middle Ages*, 2 vols., London, Kegan Paul, Trench & Trubner, 1926.

Vol. 1: xv, 208 pp. This is the main part of the book and comprises a discussion of al-Zahrawi's *al-Tasrif* and its influence on Europe in the later Middle Ages.

Vol. 2: 235 pp.; Bibl.: pp. 221–227; Index. Appendix I: "Latin translations of Arabic works". Appendix II: "An investigation into the Date and Authorship of the Latin versions of Galen".

On al-Zahrawi [Albucasis], see also nos. 287–290 above.

369. Christie, A.H. "Islamic Minor Arts and Their Influence upon European Works," in Arnold and Guillaume, eds, *Legacy of Islam* (1st ed., 1931), pp. 108–151.

For full bibliographical details, see no. 364 above.

370. Daniel, Norman A. *Islam and the West: the Making of an Image*, Edinburgh, Edinburgh University Press, 1980. xi, 448 pp.; Bibl.: pp.

395–432; Index. Orig. publ.: 1960.

Based only on European sources. Includes a discussion of the impact of Islamic science on Europe.

371. Dannenfeldt, K. "The Renaissance, Humanists and the Knowledge of Arabic," *Studies in the Renaissance*, 2 (1955), 96–117.
372. Denomy, Alexander J. "Concerning the Accessibility of Arabic Influence to the Earliest Provençal Troubadours," *Medieval Studies*, 15 (1953), 147–158.
373. Dunlop, D.M. "Arabic Medicine in England," *Journal of the History of Medicine and Allied Sciences*, 11 (1956), 166–182.
374. Gabrieli, Francesco. "The Transmission of Learning and Literary Influences to Western Europe," in Holt, *et al.*, *Cambridge History of Islam*, Cambridge (1970), pp. 851–889.

See full bibliographical details, see no. 87 above.

375. Gibb, H(amilton) A.R. "The Influence of Islamic Culture in Medieval Europe," *Bulletin of the John Rylands Library*, 38 (1955).
376. Hartner, Willy. "The Islamic astronomical background of Nicholas Copernicus," in *Colloquia Copernicana, III: Astronomy of Copernicus and its Background*, (Studia Copernica, 13) Wrocław, Ossolineum, 1975, pp. 7–16.

For another entry on Copernicus and Moorish Spain, see Rosen, E., no. 390 below.

377. Haskins, Charles H. *The Renaissance of the Twelfth Century*, Cambridge, Mass., Harvard University Press, 1927; Cleveland, OH/New York, The World Publishing Co., (Meridian Books, M 49), 1968. viii, 437 pp. Bibl. notes; Index.

The author argues that the twelfth-century Renaissance in Europe was due both to Arabic (Spain, Sicily, Syria, and Africa) and Greek (Constantinople) influences.

For other entries by Haskins, see nos. 306, 307 above.

378. Hitti, Philip, K. *The Arabs. A Short History*. See especially chapter entitled "Contributions to the West," pp. 133–146.

For full bibliographical details see above, no. 83.

379. *Islamic and Arabic contribution to the European Renaissance*, [Cairo], Assoc. Inst. for the Study and Presentation of Arab Cultural Values, 1977.

380. Johnson, Rosalind, "African Presence in Shakespearean Drama: Parallels between Othello and the Historical Leo Africanus," in Ivan Van Sertima, ed., *African Presence in Early Europe* (1985), pp. 276–287.

The author argues that Shakespeare drew on the life story of Leo Africanus (an English translation of whose book was published in London in 1600) for his creation of the dramatic character Othello.

For full bibliographical details, see Ivan Van Sertima, ed., no. 146.

For other entries on Leo Africanus, see nos. 181, 182 above.

381. Male, E. "Les influences arabes dans l'art roman," *Revue des Deux Mondes*, 18 (1923), 311–343.
382. Millas-Vallicrosa, Jos M. "Arab and Hebrew Contributions to Spanish Culture," *Cahiers d'Histoire Mondiale/Journal of World History*, VI (1960–1961), 732–751.

For another entry by Millas-Vallicrosa, see no. 333 above.

383. Murray, Harold J.R. (1869–1955). *A History of Chess*, Oxford, Clarendon Press, 1913; corrected reprint: Oxford, Clarendon Press, 1962. Ill.; 900 pp.; Bibl. refs.
384. Myers, E. A. *Arabic Thought and the Western World*, New York, Frederick Ungar, 1964.

Provides a survey of the Islamic scientists, theologians and philosophers who had an impact on the growth of science and culture in Europe.

385. Nykl, Alois R. "L'influence arabe-andalouse sur les troubadours," *Bulletin Hispanique*, 41 (1939), 305–315.

See also the next two entries.

386. Nykl, Alois R. *Troubadour Studies*, Cambridge, Mass., Harvard University Press, 1944.

387. Nykl, Alois R. *Hispano-Arabic Poetry and Its Relations with the Old Provençal Troubadours*, Baltimore, Hispanic Society, J.H. Furst, 1946; reprinted 1970; xxvii, 416 pp.; plates. Bibl. refs.

388. O'Leary, De Lacy E. (1872–1957). *Arabic Thought and Its Place in History*, London, Egan Paul, Trench, Trubner & Co., New York, E. P. Dutton & Co., 1922. vii, 320 pp.; Chron. Table.

Relevant chapters include "The Western Philosophy" (North Africa and Spain) and the "Influence of the Arabic Philosophers on Latin Scholasticism".

389. Read, Jan. *The Moors in Spain and Portugal* (1974). See particularly Chapter XXVI: "Moors and Christians. The Moorish Legacy to Spain and Portugal," pp. 232–239.

For full bibliographical details, see above, no. 132.

390. Rosen, E. "Copernicus and al-Bitruji," *Centaurus*, 7 (1961), 152–156. Alpetragius [al-Bitruji] and Averroës [Ibn Rushd] are two of the Islamic scientists cited by Copernicus in his *De Revolutionibus Orbium Coelestium (On the Revolutions of the Heavenly Spheres)*, Newton Abbot, U.K., David & Charles/New York, Barnes & Noble, 1976), originally published in Nuremberg in 1543. A Latin translation of al-Bitruji's book on astronomy was published in Venice in 1531.

For other entries on al-Bitruji, see above, nos. 294, and 350; for another entry on Copernicus, see no. 376.

391. Rosenthal, E. "Traces of Arab Influence in Portugal," *Islamic Culture*, X (1936), 1-17.
392. Rosenthal E. "Traces of Arab Influence in Spain," *Islamic Culture*, XI (1937), 324-340.
393. Salloum, Habeeb. "Arab Contributions to rural life in Spain," *Contemp. Review*, 251 (1987), 249-253.
394. Schacht, Joseph with Bosworth, C.E., eds. *The Legacy of Islam*, Oxford, Oxford University Press, 1974/1979. 2nd. ed. vi, 530 pp. 63 figs. Bibl. Refs. & Chapter Bibliographies.

Besides the chapter by Francesco Gabrieli on "Islam in the Mediterranean World," most other articles also refer to Moorish Spain.

For the First Edition, see Arnold and Guillaume, no. 364; for selected chapters in the 2nd ed., see Anawati, Georges C., no. 202, Plessner, Martin, no. 345, Vernet, J., no. 358, and Wright, O., no. 360.

395. Southern, Richard W. *Western Views of Islam in the Middle Ages*, Cambridge, Mass., Harvard University Press, 1962. 114 pp.; Bibl. refs.
396. Spaulding, Robert K. *How Spanish Grew*, Berkeley & Los Angeles, The University of California Press, 1967. xii, 259 pp.; Bibliographies and Index.

Includes a discussion of the Arabic influence on the Spanish language.

397. Steiger, Arnald. *Origin and Spread of Oriental Words in European Languages*, New York, S.F. Vann, 1963. 73 pp. Bibl. refs.

A discussion of the impact of Arabic and Persian on European languages like Spanish, Portuguese and Italian. A sample of words of Arabic origin in English includes: *Admiral, alchemy, alcohol, algebra, algorithm, alkali, amber, arabesque, azimuth, candy, cipher, chemistry* (like *alchemy* ultimately derived from an ancient Egyptian (Mdu Ntr) root), *coffee, lemon, nadir, sheikh/sheik, sugar, tariff, and zenith*.

398. Stocquart, E. "La domination arabe en Espagne: son influence juridique et sociale," *Revue de l'Université de Bruxelles*, 10 (1904/1905), 465-480.
399. Thompson, J(ames) W (1869-1941). "The Introduction of Arabic Sciences into Lorraine in the Tenth Century," *Isis*, 12 (1929), 189-193.
400. Watt, W. M. *The Influence of Islam on Medieval Europe*, Edinburgh, Edinburgh University Press, 1972. [Islamic Survey, No. 9], viii, 125 pp.; Bibl. refs.

A good overall introduction to the impact of the Islamic world (including Moorish Spain) on medieval Europe and the early Modern World.

Biographical Notes on Contributors

ALI, Yusef

Yusef Ali, a professional musician for more than thirty years, is the Director of the Paul Robeson Cultural Center at Rutgers University, in New Brunswick, N.J. Holding this position since 1980 he has also been lecturer on African-American music history in the department of Africana Studies since 1982. Yusef, a Paul Robeson scholar, and member of Kappa Delta Pi, a national honor society in education, earned his BA in music and Anthropology and a Masters in Education at Rutgers University.

BRUNSON, James E.

Art historian James E. Brunson is employed at Northern Illinois University in DeKalb, Illinois. He has taught part-time in the N.I.U. Art Department, and received his Master of Fine Arts Degree in Painting and Drawing from the same institution. He has exhibited his work throughout the Midwestern and Southern United States. He has recently completed a lithographic series on the African Presence in Kemetic Mythology. He is currently completing documentation for an educational course on *The African Image in World Art*.

Brunson has been a regular contributor to the *Journal of African Civilizations*. These contributions include: "The African Presence in the Ancient Mediterranean Isles and Mainland Greece," in 1985; "The African Presence in Early China" and "Unexpected Black Faces in Early Asia: A Photo Essay" in 1988; "Ancient Egyptians: The Dark Red Race Myth" and "Ethnic or Symbolic: Blackness and Human Images in Ancient Egyptian Art" in 1989.

In 1985 Brunson wrote and published *Black Jade: The African Presence in the Ancient East and Other Essays*. In 1989 he authored and published: *Before the Unification: Predynastic Egypt; The Image of the Black in Eastern Art; and Kamite Brotherhood: African Origins in Early Asia*. In 1990 he authored and published: *The Black Canaanites from the Earliest Times and Image of the Black in West Asian Art*. For information write: James E. Brunson, Grant Towers North # 202 C, DeKalb, IL 60115.

CAREW, Jan

Jan Rynveld Carew, DSc. Born Agricola, Guyana, 1920. Educated Berbice High School, Guyana. Howard University, Washington, D.C. Western Reserve University, Cleveland, Ohio. Charles University, Prague. La Sorbonne, Paris. Novelist, playwright, poet, educator. Professor Emeritus (African-American and Third World Studies) Northwestern University, Evanston, IL.

President, Association of Caribbean Studies. Author of *Black Midas, The Wild Coast, The Last Barbarian, Moscow Is Not My Mecca*, (Novels). *Street of Eternity, Sea-Drums in my Blood*, (poetry) *Grenada: The Hour Will Strike Again, Rape of Paradise*, (history) *Fulcrums of Change: Columbus and the Origins of Racism in the Americas*, (essays) *The Third Gift, Children of the Sun, Manco's Rainforest Stories, The Riverman, The Sisters*, (Children's books). *Black Horse, Pale Rider, University of Hunger*, (plays).

CHANDLER, Wayne B.

Wayne B. Chandler is an Anthropotojournalist and Co-Chairman of What's A Face Inc. He has done extensive research into the origins of race and ancient civilizations and is co-producer and writer of A People's History To Date—4000 B.C. to 1985 and 365 Days of Black History, parts I and II. Through the photo archives of What's A Face Inc. Mr. Chandler and his associate Mr. Gaynell Catherine have been instrumental in unearthing key photographs relating to the African presence in the Olmec civilization, as well as the civilizations of ancient India, Southeast Asia, Egypt, and China. He is a committee member of the Historian Roundtable and has lectured in various locations in the U.S. He was visiting lecturer at the University of D.C. from 1978-1983 and instructor at the prestigious Ananda Institute from 1982-1986. In 1984 he helped implement the program Genius Transformation which proved that when under-privileged children are exposed to proper historical information, along with diet and exercise, their psychological perspectives undergo a radical change for the better. From 1987 through 1989, he was working with archaeologist Dr. Edward Otter on various excavations of pre-historic Indian sites in the southeast and midwest. He has been involved with the Journal of African Civilizations since 1985 and his contributions include "Jewel in the Lotus: The Ethiopian Presence in the Indus Valley Civilization" (1985); "The Moors: Light of Europe's Dark Age" (1986); "Trait-Influences in Meso-America: the African-Asian connection" (1987); "Hannibal: Nemesis of Rome" (1988); and "Of Gods and Men: Egypt's Old Kingdom" (1989). Current project is a collaboration with Creative Fox Associates in the production of "Strangers in Their Own Land", a five part documentary involving Drs. Van Sertima, Runoko Rashidi, Asa Hillard III, and Alexander Von Wuthenau. Any comments regarding chapters published or unpublished are gladly welcome. He may be reached at P.O. Box 928, Adelphi, Maryland 20783.

CHINYELU, Mamadou

Mamadou Chinyelu has, over the past twenty years, published more than 400 articles—including news features, reviews, historical and journalistic

commentary on critical issues and notable personalities. He is a specialist in the use of the print and broadcast media, as well as in the development of community-based arts and cultural activity and institutions. He has produced festivals, musical concerts, art and historical exhibitions, lecture series and workshops. Chinyelu is also a short story writer, playwright and lecturer. His previous contribution to the Journal of African Civilization was the chapter on Frederick Douglass in *Great Black Leaders: Ancient and Modern* (1988).

JACKSON, John G.

John Glover Jackson was born on April 1, 1907 in Aiken, South Carolina. In 1922, at the age of fifteen, he moved to Harlem, New York, where he entered Stuyvesant High School. During his student days Jackson commenced to do active research, and was soon writing articles about African-American culture and history. These essays were so impressive that in 1925, while still a high school student, Jackson was invited to write articles for the Honorable Marcus Garvey's *Negro World*.

In addition to his activities as a writer, in 1930 Jackson became a lecturer at both the Ingersoll Form and the Harlem Unitarian Church. Among his teachers and associates during this period were such immortal figures as Hubert Henry Harrison, Arthur Alfonso Schomburg, Joel Augustus Rogers and Willis Nathaniel Huggins.

In 1932 Jackson became the Associate Director of the Blyden Society. Named after the great Pan-Africanist, Edward Wilmot Blyden (1832-1912), the Blyden Society performed an outstanding role as a support group for Ethiopia after the brutal Italian invasion of that country in 1935. The Blyden Society was then under the leadership of Dr. Willis Nathaniel Huggins. Among the very early and, as Jackson is quick to point out, most talented members of the Blyden Society is the now highly respected John Henrik Clarke.

In 1934 Jackson co-authored with Willis Huggins *A Guide to the Study of African History*, and in 1937—also with Dr. Huggins—*Introduction to African Civilizations*. In 1939 he authored *Ethiopia and the Origin of Civilization*, and *Pagan Origins of the Christ Myth* in 1941. His historical essays were published regularly in *The Truthseeker Magazine* from 1930 until 1955.

Professor Jackson has written several books that contain chapters on the Moors. These include: *Introduction to African Civilizations* (1970) *Man, God, and Civilization* (1972) and *Ages of Gold and Silver* (1990). He has taught and lectured at colleges and universities throughout the United States and resides now in Chicago, Illinois.

LUMPKIN, Beatrice

An associate professor of mathematics at Malcolm X College in Chicago, Professor Lumpkin has written on the Afro-Asian foundations of mathematics for *Freedomways*, the *Mathematics Teacher*, *Science and Society* and *Historia Mathematica*. She has also written two major articles for Vol. 2, Nos. 1 & 2 of the *Journal of African Civilizations*—"The Pyramids—Ancient Showcase of Science and Technology" and "Africa in the Mainstream of Mathematics History." She is author of a children's book, *Young Genius in Old Egypt*.

PATTEN-VAN SERTIMA, Jacqueline

Jacqueline Patten-Van Sertima is photographic consultant, art director and cover designer for the *Journal of African Civilizations*. Mrs. Van Sertima has also recently established the Journal's new audio arm, Legacies, Inc. As director, she produces companion audio cassettes to each volume of the *Journal of African Civilizations* as well as of various presentations made by Dr. Van Sertima and colleagues.

As a photographer, Mrs. Van Sertima has won international distinction for her hand-painted photography and its significant contribution to social awareness. Listed in the Cambridge *World's Who's Who of Women* for "distinguished achievement," their *International Register of Profiles* and their *International Who's Who of Intellectuals*, she is given equal acclaim in the United States in *Who's Who in America* and *Personalities of America* for "outstanding artistic achievement and contributions to society." Mrs. Van Sertima received her B.S. degree in Psychology/Sociology and M.S. in Education from Hunter College, New York.

PIMIANTA-BEY, José

José V. Pimienta-Bey was born and raised on Long Island (N.Y.) to Cuban and Moorish parents. He received his B.A. in History from Gettysburg College (Pa.) in 1984 and his M.A. in History from Shippensburg University (Pa.) in 1987. Since 1985, his primary research interest has been the Moors and their impact upon the development of European academic institutions and society. Since 1988, Mr. Pimienta-Bey has been a Doctoral Student and Instructor in the Dept. of African American Studies at Temple University (Phila, Pa.), the first and only program in the country to offer a Ph.D in African American Studies. He has given several lectures in the Philadelphia area on Moorish cultural and scientific influences, including the Thomas Jefferson Medical School.

RASHIDI, Runoko

Runoko Rashidi is an African-Centric historian, writer and lecturer with a pronounced interest in the African foundations of world civilizations. He has appeared on numerous television and radio programs, and has lectured extensively in India, England and throughout the United States. From 1981 to 1984 he was African History Research Specialist at Compton College in Compton, California. Among the major programs he developed and coordinated during this period were: The African People's Conference, An Evening for the *Journal of African Civilizations*, The African Presence in Early America, The African Presence in Early Europe, and The Significance of the Pyramid in African History. From 1985 to 1987 Rashidi was the History Editor for the National Black Computer Network. Since 1983, he has been an active member of the Board of Directors and the Board of Editors of the *Journal of African Civilizations*. In 1990 Rashidi was listed in the Smithsonian Institution's *Directory of African American Folklorists*.

Since 1982, Runoko Rashidi has been a major contributor to the *Journal of African Civilizations*. Rashidi's J.A.C. essays include: "The African Presence in Sumer and Elam" in 1982, "African Goddesses: Mothers of Civilization" in 1983, "The Nile Valley Presence in Asian Antiquity" in 1984, "The African Presence in Early Asian Civilizations" in 1985, "Ancient and Modern Britons" in 1985, "Dr. Diop on Asia" Highlights and Insights" in 1986 (noted and reviewed in *Presence Africaine*, 2nd Qtr. 1987), "Men Out of Asia: The Black Presence in Prehistoric America" in 1987, "More Light on Sumer, Elam and India" in 1988, "Ramses the Great: The Life and Times of a Bold, Black Egyptian King" in 1988, "A Working Chronology of the Royal Kemetic Dynasties" and "The Middle Kingdom of Kemet: A Photo Essay" in 1989.

In 1988 Rashidi edited with Ivan Van Sertima *The African Presence in Early Asia* (New Brunswick: Journal of African Civilizations). One of Rashidi's most recent and comprehensive works, *A Guide to the Study of African Classical Civilization*, is scheduled for publication in March 1991 by Karnak House of London, England.

On October 8, 1987 Rashidi formally inaugurated the "First All India Dalit Writers Conference" in Hyderabad, India, and delivered a major address on "The Global Unity of African People." In 1989 he was appointed United States Representative of *Dalit Voice: The Voice of the Persecuted Nationalities Denied Human Rights*, issuing from New Delhi, India, and published in English, Tamil, Urdu, Telugu, Malayalam and Hindi. For further information write to: Rashidi, 4140 Buckingham Road, Suite D, Los Angeles, CA 90008; or call (213) 293-5807.

REYNOLDS, Dana

Dana Reynolds is currently a graduate student at Columbia University's School of International Affairs concentrating on the history and political economy of peoples of the Sahara and Sahel. She is also a research and writing assistant at the Center for American Cultural studies at Columbia which is presently working on the first African American encyclopedia. She has taught Sociology courses as an adjunct instructor at Glassboro State College. In 1988 she completed the program for the Masters in Social Sciences at the University of Chicago where she concentrated on history, archaeology and anthropology of the ancient Sahara and North Africa. She spent a semester in 1984 in the School at the Louvre (L'Ecole du Louvre) studying art history and the archaeology of ancient Europe. In 1985 and 1986 she was a translator of Egyptological texts from French to English for Dr. Zahi Hawass, Director of the Inspectorate for Giza antiquities in Egypt. She has been involved for the last ten years in the research and study of problems in African history and anthropological theory.

RAVELL, James

James J. Ravell was born in Bellville, Cape, South Africa. He gained the B.A. degree and the Secondary Teacher's Certificate from the University of Cape Town. While teaching at a high school in the Cape Peninsula, he was awarded a Dutch graduate scholarship. However, the South African Government refused him a passport so that he was forced to leave the country in 1967 on a one-way exit permit, which cost him his South African citizenship. He holds the degree of *Doctorandus in History* (Drs. Hist.) from the State University of Utrecht, The Netherlands.

In South Africa, he was active in the political, educational, and cultural struggle against Apartheid, and has since continued his anti-Apartheid work overseas.

Ravell is the Afrikaans translator of Bertrand Russell's *Why I Am Not A Christian*, which caused a stir in South Africa upon its publication in 1960. He is coauthor of a book in Dutch entitled *Kan namens mig een blanke spreken? Zwarte Literatuur in Zuid-Afrika* (Can the white man speak for me? Black Literature in South Africa), Utrecht, Werkgrope Kairos, 1982. His other publications include: (as translator): J. Van Goor, *Jan Kompenie as Schoolmaster. Dutch Education in Ceylon 1690-1795*, Groningen, The Netherlands, Wolters-Noordhoof, 1978; Peter Geschiere, *Village Communities and the State. Changing Relations among the Maka of Southeastern Cameroon since the Colonial Conquest*, London/Boston, Kegan Paul International, 1982; and (as literary collaborator/editor): Piet Konings, *The State*

and *Rural Class Formation in Ghana. A Comparative Analysis*, London/Boston, Kegan Paul International, 1986.

Between August 1984 and June 1986, Ravell was a Visiting Assistance Professor in History (World Civilization, African Civilization and South African History) at Spelman College, Atlanta, and since that time up to mid-1991, he taught African Civilization and African American History in the Department of African American Studies at Temple University, Philadelphia, Pennsylvania.

Ravell serves on the editorial board of the *Journal of Black Studies* (Temple University) and has recently been appointed to the editorial board of the *Journal of Negro Education* (Howard University).

SCOBIE, Edward

Associate professor of history, Black Studies Department, City College of New York; formerly associate professor, Afro-American and Political Science Department, Livingston College, Rutgers University. Visiting professor, Princeton University since 1973. Working journalist, poet, radio and television broadcaster and scripwriter, teacher and writer in London, England from 1941 to 1964. Editor, *Flamingo*, a monthly magazine published in London. Twice Mayor of Roseau, capital of Dominica, West Indies; vice-president, Dominica Freedom Party; owner-publisher Dominica Herald, a weekly newspaper. Author, *Black Britannia: History of Blacks in Britain*.

VAN SERTIMA, Ivan

Ivan Van Sertima was born in Guyana, South America. He was educated at the School of Oriental and African Studies, London University and the Rutgers Graduate School and holds degrees in African Studies, Linguistics and Anthropology.

He is a literary critic, a linguist, and an anthropologist and has made a name in all three fields.

As a literary critic, he is the author of *Caribbean Writers*, a collection of critical essays on the Caribbean novel. He is also the author of several major literary reviews published in Denmark, India, Britain and the United States. He was honored for his work in this field by being asked by the Nobel Committee of the Swedish academy to nominate candidates for the Nobel Prize in Literature from 1976-1980. He has also been honored, as an historian of world repute, by being invited by UNESCO to join the *International Commission for Rewriting the Scientific and Cultural History of Mankind*.

As a linguist, he has published essays on the dialect of the Sea Islands off the Georgia Coast. He is also the compiler of the *Swahili Dictionary of Legal Terms*, based on his field work in Tanzania, East Africa, in 1967.

He is the author of *They Came Before Columbus: The African Presence in Ancient America*, which was published by Random House in 1977 and is now in its sixteenth printing. It was published in French in 1981 and in the same year was awarded the Clarence L. Holte Prize, a prize awarded every two years "for a work of excellence in literature and the humanities relating to the cultural heritage of Africa and the African diaspora".

Associate Professor of African Studies at Rutgers University, Van Sertima was also Visiting Professor at Princeton University for five semesters. He is the Editor of the *Journal of African Civilizations* which he founded in 1979. Professor Van Sertima has lectured to more than 100 universities in the United States and has also lectured in Canada, the Caribbean, South America and Europe. He appeared before Congress on July 7, 1987 to challenge the Columbus myth.

ZITZLER, Siham

Associate professor of mathematics at Loop College in Chicago. She has taught in the Faculty of Science, Lebanese University, the American University of Beirut, and the Massachusetts Institute of Technology.

Index

- Al-Zargali, 348
 Albert the Great, 393
 Abu Masur, 143
 Alessandro dei Medici, 341
 African ancestry, 334
 mother, 335
 Aldridge, Ira, 272, 332
 Alexandria library, *see* Library at Alexandria
 Alfonso VI, 173, 373
 Alfonso VII, 258
 Alfonso VIII, 10
 Alfonso X, 316
 as author of *Cantigas de Santa Maria*, 7, 28, 368
 commitment to Moorish scholarship, 224
 schools of translation, 18, 183
 Algazel, 205
 Algebra, 385, 387
 Algeria, 373
 The Alhambra, 142, 248
 Alhazen, 382, 388–391
 association with Dar-el-Hikma, 388
 camera obscura principle, 390
 geometry, non-Euclidean, 389
 influence on European scientists, 388
 integral calculus, 390
 physiology of vision, 388, 390
 A Bu'L Abbas, 162
 Abbasid dynasty, 162
 Abd-al-Mu'min, 9
 Abd-al-Rahmin II, 266
 Abd-al-Rahman III, 57, 170
 Abd-er-Rahman III, 87
 Abdul Aziz ibn-Saud, 363
 Abdullah, 340
 Abdurrahmon
 administration, 164
 cultural accomplishments, 164
 exile, 162
 land reforms, 164
 successors, 170
 Abraham ben Ezra, 296
 Abreha, 69–70
 Abu Abdallah, *see* Boabdil
 Abu Bakar, 171
 Abu Bekr, 87
 Abu Ga'far, 9
 Abu Kamil, 385–387
 Abu Shama, 57
 Abu-l-Asbag Isa Bin Kuzman, 315
 Abulcasis, 218
 Adelard of Bath, 83
 as an apprentice of "Moorish/Arab" erudition, 233
 in Spain, 206
 translations, 232
 Admantius, 114
 Aemilius Aemilianus, 47
 Aesop, 267
 African Glory: the Story of Vanished Negro Civilization, 89, 331, 333
 Africans, phenotypic adaptation to desert environment, 104
 Afro-Asians, 376
 languages, 101
 Afro-semitic people, description, 102
 Agades, 283
 Agriculture, 257–258
 A'isha, 249
 al-Andalus, *see* Spain
 Al-Hira, 294
 Al-Idrisi, 227–228
 Al-Isfahani, 296
 Al Jahiz, 375
 Al-Jwarizimi, 207
 Al-Kahina, 57

- Al-Khwarizmi, 232, 385
 Al-Madani, 220
 Al-Mamun, 207
 Al-Mansour, 170
 Al-Mansur, *see* Ya'kub ibn Yusuf
 Al-Mas'udi, 383
 Al-Tasrif, 218
 Ali ibn Abd Allah, 372, 374
 Almohade dynasty, 88, *see also*
 Almohades
 cultural contributions, 142–143, 175
 origins, 138, 175
 Almohades
 interest in intellectual pursuits, 205
 leader, 370, 374 as “pure Africans”,
 204
 racial bigotry, 9
 Almoravid dynasty, 28, 252, *see also*
 Almoravids
 Amazons, original, 37
 black Africans in, 173, 175
 demise, 142
 length of, 142
 origins, 138, 175
 rulers, 175
 warriors, 152
 Almoravids, 87
 Algerian conquest, 373
 black color, 253
 as devout followers of Islam, 253
 extent of empire, 373
 Islamic definition, 373
 leader, 370
 Morabites as antecedents, 87
 Moroccan conquest, 373
 origins, 87, 171
 Amazons, 113
 Ammianus Marcellinus, 100, 105
 Anati, Emmanuel, 101
 Anaxagoras, 209
 Ancient Britons, 339
 Antar, 70, 363
 Anthropology of Music, 281
 Aquinas, Thomas, 183
 The Arab Heritage of Western Civilization,
 22
 Arabia, *see also* Arabs
 Africans in, 101–102, 105
 ancient vs modern, ethnicity of its
 people, 99
 as an extension of Africa, 282
 first inhabitants, color of, 158–159
 pre-Islamic, 67–70
 Saracens in, 105
 Arabs
 bio-cultural correlation with Africans,
 189
 commercial ties to Africa, 106
 conquest of Africa, 333
 Cushitic origins, 360
 dark complexion, 100
 ethnic origins, 100, 189, 251, 282, 331,
 360
 language, 11, 202, 383
 mathematical contributions, 205–206
 miscegenation, 158, 160, 189, 191, 331
 music, 294–308
 physical description, 100, 159
 Aragon, 41
 Arbolayre, 226
 Archimedes, 396
 debt to Egyptian mathematicians, 397–
 398
 Architecture, 337
 Aristotle
 Averroes's translations, 260
 first appearance of texts in Europe, 348
 flight from Athens, 209
 Moorish translations of texts, 164, 254,
 260
 Arithmetic, 232
 Arkell, A., 121, 126
 Arnold, Thomas, 369, 372
 Asin-Palacios, Miguel, 189, 231
 Asparagus, 267
 Astrolabe, 262
 Astrolabe, 233
 Astronomy, 143, 225
 Ata ibn Abi Rabah, 71
 Athena, 113
 Atlantic slave trade, *see* Slavery
 Aubry, Pierre, 318
 Auden, W. H., 268
 Avempace, 216
 Avenzoar, 218, 226
 medical writings, 218
 Averroes, 175, 391
 birth, 260
 contributions to medicine, 216
 Dante's evaluation, 260
 impact on Scholasticism, 216
 influence on European science, 393

- philosophy, 260
 Thomas Aquinas's dependence on
 commentaries, 231
 translations, 222
 translations of Aristotle, 260
 Avey, Albert E., 234
 Avicenna, 222
 Dante's evaluation, 260
 geological contributions, 216
 influence on European science, 393
 medical writings, 216
 musical contributions, 297
 pharmacological extracts, 226
 Ayyub ibn-Habib, 340
 Azzahra, 166
 Bacon, Roger, 183, 388
 censorship, 231–232
 Balbus, 128
 Banu Musa bin Shakir, 383
 Barakat, 360
 Barbosa, Duarte, 370
 Barram, Ghur, 294
 Barrow, Isaac, 388
 Bates, Oric, 109, 121, 123
 Batrikus, 1
 Berbers
 ancestors, 125, 138, 144, 369
 Arab prejudice toward, 55–56
 black, 57, 61
 clans, 37
 conversion to Islam, 369
 dancers and musicians, 287
 defined, 106, 143–144
 ethnic origins, 4, 37, 98, 194–195, 204
 groups, 57, 61
 industriousness, 42
 Judaism among, 61
 language, 106
 Libyan relationship, 156
 modern vs ancient, 106
 Moorish ties, 37, 94–95, 97, 107
 music, 293
 Nubian affiliation, archaeological
 evidence for, 123–125
 origins of the term, 107–108
 in Portugal, 57
 resistance to Arab invasion of North
 Africa, 57
 Roman definition, 108
 in Spain, 57
 tribes, 57, 171
 Trogodytes's relationship, 126
 true conquerors of Spain, 370
 women, 37, 143
 Bernal, Martin, 210
 Bilal, 8, 286, 360
 Abyssinian ancestry, 299
 death, 305
 devotion to Islam, 305
 ethnicity, 158
 as an intimate of Muhammad, 158, 299
 Black Athena, 210
 Blemmyes, 100, 125, 138
 Blyden, Edward W., 363, 367
 Boabdil, 13, 88, 248
 Bohannon, Paul, 279
 Bologna, 230
 The Book of Examples and Collections
 from the Early and Subsequent
 Information Concerning the Days of
 Arabs and Non-Arabs, Berbers, 255
 Book of Himyarites, 69
 The Book of Ingenious Devices, 383
 The Book of Songs, 296
 Borges, 266
 Bovill, E. W., 153, 158
 Boyer, Carl, 394
 Brace, Richard, 187, 189
 Bradley, Michael, 236
 Brahe, Tycho, 388
 Bruno, Jordano, 234, 236
 Burckhardt, Titus, 184
 Burton, Richard, 102
 C-group population, 121, 123
 Cadiz, 1
 Camarque, 130
 Camps, G., 107, 121
 Canon, 216, 227
 Cantigas de Santa Maria
 author, 7, 28
 illustrations from, 28, 368
 use of Andalusian metric system, 318
 Caron, Pierre, 226
 Carra de Vaux, B., 205
 Carthage, 117
 Carthaginians, 127
 Castile of Gibraltar, 88
 Catholic Church, destruction of Moorish
 manuscripts, 236, 248
 Cervantes, 260, 273–274

- Chad, 100
 Chandler, Wayne, 45, 187, 299
Chanson de Roland, see *Song of Roland*
 Charlemagne, 200
 Charles ("the Hammer"), 229
 Charles Martel, 361
 Charles of Anjou, 228
 Chartres, school, forerunner of the University of Paris, 229
 Chejne, Anwar, 201, 206, 230
 African music, 289
 Arabic influence upon European languages, 202
 Persian support of science, 207
 Chemistry, 220
 Chernoff, John M., 278
 Chess, 362
 China, 151
 el Cid, see Rodrigo Diaz de Bivar
 City planning, 166
 Clebert, Jean-Paul, 42
 Cleodemus, 106
 Clock, water, 384
Colliget, 216, 227
 Coltrane, John, 281, 320
 Columbus, Christopher, 274
 use of astrolabe, 262
Commentario-Rum in Esaiam, 42
 Comries, B., 194
Concionero de Palacio, 316
 Constantine, 393
 Constantinus Africanus, 226–227, 230
 Coppee, Henry, 204
 Coptic Church, 367
 Cordoba, 57, 86
 conservatory of music, 266, 311
 as a cultural center, 266, 311
 description, 166, 213–214, 377
 education, 282
 libraries,
 mosque, 256
 paved streets, 355
 street lamps, 355
 university, 205, 236
 Ziryab, as arbiter of taste in, 313
 Corippus, 4, 49, 95, 110, 111
 description of Moors, 1g4
 Cotton, 10
 Crete, 10
Cronica General, 2
 Crow, John, 176
 Crusades, 393
 Cueta, 371
 Cush, 151, 176
 Dance, 97
 Dante, 260
 Dar-el-Hikma, 382
 David, Rosalie, 256
 Davidson, Basil, 336
 Davis, Miles, 281–282, 320
 Daya Kahena, 128, 130
 De Graft-Johnson, John, 89–90, 331, 367
 Deboo, Gordon, 384
 Debrunner, Hans, 153
 Dental hygiene, 267
 Desanges, J., 367
 Devise, Jean, 36, 42
 Dia Kahena, see Daya Kahena
 Diodorus Siculus, 111, 113
 description of ancient Libyans, 116
 Diop, Chiekh Anta, 6, 396
 Africans as original Arabs, 189, 360
 ethnicity of Moors, 185
Dirt: A Social History As Seen Through the Uses and Abuses of Dirt,
Divine Comedy, 260
Don Quixote, 264, 273–274
 Dozy, Reinhart, 370, 372, 373
 Draper, John William, 352
 Du Bois, W. E. B., 156, 161, 370
 conquest of Spain, 162
 description of Yusuf Ibn Tashifin, 173
 origins of Greek culture, 363
 use of the word "Arab", 159
 Duff, Charles, 274
 Dulcert, Angelino, 270
The Eastern Libyans, 109, 123
 Eecke, Paul ver, 397
 Egilona, 338
 Egypt
 musical contributions, 286
 Muslim conquest, 364
 Eighth International Congress for the History of Medicine, 227
 Ella Asbeha, 69
 England, 66, 339, 345
 discrimination against Moors, 66–67
 evidences of Moorish presence, 339, 342, 343, 350
 Eratosthenes, 398

- Ethiopia, 68, 70–71, 107, 113, 151
 Ethiops, 151, 153
 Eucherius, 61
 Euclid, 164, 254
 Europe, 346, 347, see also specific countries
 centers of Moorish scholarship, 225
 remnants of Moorish Civilization, 143
 Renaissance, classical vs scientific, 9
 Eustathius, 110
 Exploration, 348
 economic motivation, 352
 Fairbairn, James, 192
 Farmer, Henry George, 18, 294, 296
 instrumental music as major Moorish contribution, 320
 intellectual life in Cordoba, 282
 Fatima, 337
 Fatimid dynasty, 138
 Fezan, 153
 Fibonacci, Leonardo, 386, 393
 Flute, 295, 316
 Ford, Richard, 257
 Fox-Davies A., 192, 195
 France, 66, 340
 Moorish invasion, 130, 372
 participation in slave trade, 168
 Frederick II, 56
 interest in Moorish scholarship, 228
 Fulanis, 120–121
 Gabrinus, 113
 Galen, 164, 254
 Ganshof, Françoise, 205
 Garamantes, 5, 153
 agricultural endeavors, 153
 black color, 127
 capital city, 153
 commercial exploits, 156
 as contemporaries of the Libyans, 156
 cultural origins, 153
 Egyptian influence on culture, 153
 Herodotus's mention of, 153
 homeland, 153
 as Kushite Berbers, 128
 Nubian affiliations, 128
 as sub-tribes of ancient Libyans, 127
 technological expertise, 128
 trade with the Carthaginians, 127
 García Lorca, Federico, 258, 266
 "Gate of Blacks", 56
Generalities On Medicine, 210
 Geoffrey of Vinsauf, 221–222
Geographical Historie of Africa, 15
 Geography, 227–228
 Geology, 216
 Gerbert of Aurillac, 226
 Germany, 65, 365
 Ghanaian Empire, 61, 131, 176
 chief desert port, 142
 destruction, 173
 Ghengis Khan, 258
 Gibraltar, 86
 Glick, Thomas, 36
 Gondisalvi, Dominicus, 206
 Granada, 86, 142
 fall, 175, 248
 university, 236
Grand Herbiere en Francois, 227
 Graves, Robert, 127, 128
 Greeks anti-intellectualism, 209
 cultural debt to Egyptians, 396–405
 philosophy, origins, 208–209, 210
 Groves, C. P., 333
A Guide to the Study of African History, 90
 Guillaume, Alfred, 369
 Hakam II, 57
 Hakluyt, Richard, 7, 36
 Hamilcar, Barca, 117
 Hamilton, Thomas T., 348, 349, 352
Handbook in the History of Philosophy, 234
 Hannibal, 45, 117
 Hanno, 117
 Harrison, George Bagshawe, 344
 Harun al-Rasi, 207
 Haskins, Charles H., 201, 222
 Hawkins, John, 342
Hayy ibn Yagzan, 264
 Health, 257, see also Medicine
 Heraclitus, 254
 Hermodorus, 209
 Herodotus, 113, 116, 153
 acknowledgement of Greek plagiarism, 404
 Egyptian achievements, 293
 Ethiopian empires, 364
 Libyan tribes, 109
 Higgins, Godfrey, 363
 Hincmar, 56
Historia Pontifical, 226

Historie of Africa, 331
History of Mathematics, 394
The History of Medieval Spain, 12
A History of Modern World, 178
History of the Arabs, 27
History of the Crusades, 336
History of the Intellectual Development of Europe, 352
History of the Mohammedan Dynasties in Spain, 1
History of the Moorish Empire in Europe, 89
History of West Africa, 94
Hitti, Philip K., 27
Hohenstaufen dynasty, 56
Holland, 66
Hospitals, 255
Hotson, Leslie, 344
House of Wisdom, see Dar-el-Hikma
Houston, Drusilla, 158, 360
Hrotsvitha of Gandersheim, 213
Huggins, Willis Nathaniel, 90
Hunwick, John, 282–283
Huygens, Christian, 388

Ibn Abd Rabbihi, 206
Ibn Battuta, 11, 385
Ibn Battutah, 351
Ibn Ghabib, 205
Ibn Guzman, 264
Ibn Hawkal, 37
Ibn Hawkel, 351
Ibn Haytham, see Alhazen
Ibn Hazm, 212–213
Ibn Khaldun, 255, 280, 296
Ibn Khatib, 220
Ibn Said, 88
Ibn Sina, 143
Ibn Tufail, 264
Ibn Yasin, 171
Ibn Yunus, 382, 387–388
Ibn-l-Khattib Al-Makkary, 1
Ibrahim-al-Mahdi, 8, 286
Ibrahim al-Mawsili, 266
Ibrahim al-Mosuli, 305, 306
Iceman Inheritance, 236
Imamuddin, S. S., 198
India, 151
“*Infaq al-Masuri*”, 125, 132
Introduction to African Civilization, 12, 90
Iohannis, 49

Irrigation systems, 214
Irving, T. B., 168
Irving, Washington, 360
Irwin, Graham W., 70
Ishak, 305, 307, 309, 311
Isidore, 27
Islam
 African participation, 252, 360–378
 Berber conversion, 369
 extent of empire, 202, 251, 253
 white participants, 377
Italy, 372

Jackson, John, 12
Jamblichus, 404
James, George A., 209, 210
James, George G. M., 11, 294, 400
Jectanides, 189
Jewels Arranged in Order, 391
Jews, 168, 260
John of Cremona, 228
Johannid, 95
Josephus, 106
Jugurtha, 47
Justinian, 209
Juvenal, 114

Kairouin University, 284, 285
Kaplan, Paul, 56
Karpinski, Louis Charles, 383
Kebede, Ashenafi, 280
Kepler, Johann, 388
Kettle drums, 289
Kitab-al-Ravdatayn, 57
Kitab al Sudan wa 'l-Bidan, 375
Kitab al-Taysir, 226
Kline, Morris, 394

Lacroix, Paul, 207, 229, 231
Lambert, J. H., 389
Lancelot, 65
Land, J. P. N., 296
Landau, Rom, 22
Lane-Poole, Stanley, 7, 89, 161
 contrast between Moorish Spain and other European countries, 377
 European genocide of Moors, 358
 evaluation of Spain under Moorish rule, 337
 Spain after the expulsion of Moors, 355
Leather, 354

Leo Africanus, 115, 331
Leonard of Paris, 228
Lewis, Benjamin, 221
Liber Abbaci, 393
Library at Alexandria, 164, 400, 404
Libro de las Grandezas de Espana, 1
Libya, 109–111
Libyans
 amalgamation with other races, 156
 black color, 114
 confusion with Ethiopians, 114
 as contemporaries of the Garamantes, 156
 Diodorus's description, 116
 Egyptian name, 156
 ethnohistory, 114–121, 156
 first appearance in literature, 114
 Garamantes as sub-tribe, 127
 Herodotus's record, 116
 lifestyles, 111
 military expertise, 117
 modern day remnant, 120–121
 physical description, 156
 relationship to Berbers, 156
 women, 113
Life of Mohamet, 360
Lister, Charles, 234
Lost Worlds of Africa, 94
Lotfi, Aziz, 194
Lucien, 156
Lucy Negro, 342, 344
Lumpkin, Beatrice, 402
Lute, 168, 266, 312, 316, 317

MacRitchie, David, 339, 341
 African minstrels in courts of Great Britain, 342
 Moorish ancestors of British nobility, 346, 347

Maghrib, 7, 37
Mahdi, 88
Maimonides, 260
Ma'in, 68
Makeda, 67
Malaga, 354
Mali, 283
Malik, 340
Malm, William, 280, 288
Mandingo, 176
Mansa Musa, 270, 272, 275
Margoliouth, D. S., 18, 360

Marib Dam, 68
Mariner's compass, 354
Martial, 4, 114
Martyrdom of Arethius, 69
Massey, Gerald, 156
Mathematics, 383, 398
 algebra, 385
 algorithm, 385
 introduction of Arabic numerals, 348
The Mathematics Teacher, 388
Mattingly, D. J. 132
Mauretania, 151, 283
McCabe, Joseph, 89, 188, 213
 Church's censorship of Roger Bacon, 232
 description of Moorish gardens, 202
McLaughlin, Terence, 201
Mecca, 299
 Negro colony, 187
Medicine, 211, 214, 216, 391
 contagion theory, 220
 encyclopedia, 218
 European acquisition of expertise, 226–227
 schools, 218
 surgical instruments, 223
 theory of humors, 312
 treatises, 226
 use of antiseptics, 234
Medina, 229
Medina, Pedro de, 1
Merchant of Venice, 267, 268
Merriam, Alan, 281
Meshken, 114
Mesopotamia, 151
Metallurgy, 96
The Method, 397
Mettle, Paul, 342
Michel, P. H., 402
Mieli, Aldo, 393
Mi'raj, 267
Misagenes, 116
Mitlitzki, Dorothee, 42
Moallakat, 364
Mocadem bin Mafa, 315
Monroe, James T., 189, 212, 236
Montpellier
 description, 229
 medical school, instruction in Moorish techniques, 229
Moorish population, 229

"Moorish Army in Retreat", 368
Moorish Culture in Spain, 184
 Moors
 African features, 192
 agricultural expertise, 86, 203–205, 257–258
 architecture, relationship to Egyptian, 210
 in art 192, 193
 attempted invasion of France, 86
 Berber origins, 4, 37, 94–95, 97, 107, 184–185, 188–189
 black color, 130
 black vs tawny, 331
 in Carthaginian Wars against the Romans, 45, 47
 Catholic resentment, 227
 in central Europe, 47, 51
 city planning, 166, 202
 civilizing mission, 254
 conquest of Spain, 161–162
 conversion to Islam, 85
 cultural contributions, 143, 164–166, 168, 377
 curriculum of scholars, 213
 education, 86, 213, 282
 empire, extent of, 253
 in England, 66, 339, 342, 343, 345, 350
 Ethiops's relationship to, 153
 ethnic origins, 65, 93, 109, 143, 183, 184–197, 252, 331
 etymological origins, 27
 in European literature, 15
 during the European Renaissance, 7
 expulsion from Spain, 66–67, 175
 expunction from the annals of European history, 357
 in France, 66, 340, 372
 Garamantes as ancestors, 5
 in Germany, 365
 gold trade, 270
 historical correlations between Egyptians and, 236
 historical significance, 182
 in Holland, 66
 horsemen, agility, 47
 hospitals, 255
 image in medieval Europe, 28–36
 impact on European literature, 15, 267
 instrument-making, 18
 invasion of France, 130

irrigation systems, 214
 in Italy, 56, 372
 knights, 65
 length of Spanish rule, 176
 licentiousness and immorality, 170
 in literature, 153, 192, 201
 manuscripts, destruction of, 236, 248
 mathematical contributions, 383
 matriarchal rule, 111
 in medicine, 216, 234
 in medieval Europe, proof of ethnicity, 65
 militarism, 45–49, 56, 176
 music, 15, 17, 201, 255, 278–330, 337
 opinion of white Europeans, 336
 persecution under Ferdinand and Isabella, 251
 physical description, 95, 114
 poetry, 201–202, 263
 in Portugal, 337
 in post-Roman North Africa, 49
 Procopius's description, 111
 public health standards, 257
 in the Punic Wars, 45, 47
 racial make-up, 151
 recreations, 201
 resistance to conquest, 14
 respect for nature, 258
 rulers, intellectual achievements, 249
 scholarship, European acquisition, 183, 225–227
 science, 9–13, 164, 166, 182, 212–227, 348
 in Scotland, 66, 339, 341, 345
 sewage systems, 202
 in Shakespearean plays, 268–269
 in Sicily, 56, 372
 society, humane elements of, 201
 soil irrigation, 203, 214
 as soldiers recruited by Rome, 47
 in Spain before Arab conquest, 49–54
 Spain compared to other European countries during rule of, 377
 in Spanish art, 38–39
 in Switzerland, 372
 as symbols of evil in medieval Europe, 28
 Tawny, *see* Tawny Moors
 transformation of Iberian Peninsula, 14
 treatment; of conquered, 13
 tribes, 108

in Tudor England, 350
 union with Arabs, universities, 205
 white, *see* Tawny Moors
 women, 36
The Moors In Spain, 7, 161
 Morabit, 56
 Morabites, 87
 Morien, 65–66
 as architect of Stonehenge, 66
 physical description, 65
Morien, 65
 Morocco, 173, 373
 emperor, 371
 Morus, Johnannes, 153, 155
 Moutamen Elkhelafe, 375
 Mozarabs, 200
 Mozarebs, 250
 Mudejars, 250
 Muhammad, 158, 187
 adopted son, 360
 African affiliations, 71, 286, 360
 black Africans in the life of, 19
 death, 159, 364
 father, 71
 flight to Medina, 252
 grandfather, 360
 leadership in Moslem crusades, 159
 wife, 363
 Muhammad Bello, 125, 132
 Mulai Ismael, 369
 physical description, 371
 Munusa, 55, 340
 Murabit, 56
 Musa ibn Maymun, *see* Maimonides
 Musa ibn Nusayr, 54
 Musa Mali, *see* Mansa Musa
 Musa Nosseyr, 159
 Music, 15, 97, 201, 255, 278–330, 337
 ancient Arabians, 294–299
 of the Berbers, 293
 as chief contribution of Moors to medieval Europe, 320
 classic school, Arabian, 305–308
 as course of scientific study, 297
 Egyptian, 16, 293
 instruments, oriental Africa and Arabia, 298
 kettle drums, 289
 Mecca and Medina as centers, 299
 as medicine of the soul, 312
 Nubian, 295
 Pan-Islamic, categories, 288
 rhythmic modes, 323
 theory, 281
Music in Ancient Arabia and Spain, 278, 296
 Musical instruments, 18, 96, 316, 321
 displayed by European musicians, 322
 scientific description, 320
 Napoleon, 178, 337
 Nasr, Seyd Hossein, 22
Nature Knows No Color Line, 90, 94, 369
 Nauman, Emil, 307
 Neugebauer, Otto, 396
 Newton, Isaac, 396
 Nile Valley Conference, 6
 Norris, H. T., 55, 61
 North African tribes, origins, 2
 Nubians, music, 295
 Nugaymath, Truquia, 37
 Nunez, 227
 Oboe, 316
 O'Callahan, Joseph, 12, 197
 Ocampo, Florian de, 2
Ole', 281, 320
 O'Leary, De Lacy, 194
 Omayyad dynasty, 87
On the Equilibrium of Planes or of Their Center of Gravity, 400
On the Pentagon and Decagon, 386
Optics, 388
Othello, 153, 267
 critique, 272–273
 Otto II, 341
 Palermo, 56
 Pantheism, 234
 Pausanias, 111
 Persia, 207
Periplus of the Erythrean Sea, 69
 Pharmacology, 211, 218, 226
 Philippson, David, 121
 Phoenicians, 117, 364
 Physicians, 211, 214, 216, *see also* Medicine
Physiognomical Scriptures, 114
 Pico della Mirandola, 233
 Pimenta-Bey, Jose, 6, 9
The Planting of Christianity in Africa, 333
 Plato, 164, 209, 254

- Plato of Tivoli, 206
 Platus, 27
 Pliny, 110, 209
 Pliny the Elder, 42
 Plutarch, 209
Poema de Fernan Gonzalez, 28, 29, 36
Poema del Cid, 264
 Poetry, 201–202
 Polemon, 114
 Pope Hadrian I, 200
 Pope John VII, 56
 Pope Sylvester II, 348
 Portugal, 57, 337, 338
 Pory, John, 195
 Priest-kings, 68
Primera Cronica General, 55
Primus Canonis, 216
 Prince Henry the Navigator, 349, 355, 356
 compass of stone, 353
 use of Moorish writings, 351–352
 Procopius, 4, 49, 95, 110, 111
 description of Moors, 114, 369
 Ptolemy, 254
 Public health, 257
 Punic Wars, 45, 47
 Pythagoras, 396
 biographer, 404
 music theory, 281
- Qataban, 68
 capital, 69
 zenith, 69
Quartus Canonis, 216
 Queen Elizabeth I, 342
 Queen of Sheba, *see* Makeda
Questiones Naturales, 232
- Rabanus Maurus, 42
 Raimundo, 221
 Rashdall, Hastings, 208, 229, 230
 on the censorship of Bacon, 232
 Read, Jan, 248
 Read, Jean, 313
 Reynolds, Dana, 4
 Rhind Papyrus, 402
 Ribera, Julian, 278, 296, 318
 Arabian music, 306, 307
 Rice, 10
 Ringrose, J. A., 345
 Robert of Chester, 206
Robinson Crusoe, 264
- Roderick, 161, 338
 Rodrigo Diaz de Bivar, 373
 Roger II, 227
 Rogers, Joel Augustus, 27, 95, 195, 360, 373, 374
 Arabia as extension of Africa, 282
 Berber antecedents, 125, 369
 criteria for establishing African ancestry, 370
 evaluation of Abdul Aziz Ibn-Saud, 363
 vitae, 90–91
Romance of the Cid, 37
 Rome, 56
Roudh el-Kartas, 372
 Ruiz, Juan, 319
- Saba, 68, 69
 Sabians
 construction of the Marib Dam, 68
 matrifocal culture, 67
 navigational notability, 67
 rulers as priest-kings, 68
 script, 68
 Saint Jerome, 42
 Saint Maurice, 61–62, 65, 154
 earliest documentation, 61
 as greatest patron saint of the Holy Roman Empire, 61
 martyrdom, 62
 military leadership in Africa, 62
 monastery dedicated to, 62
 statue, African features, 62
 veneration in German cathedrals, 65
 Salvador-Daniel, Francesco, 319
 Santalla, Hugh, 206
 Saracens, 338
 black color associated with, 42
 defined, 100
 description in *Song of Roland*, 43
 in medieval literature, 43–45
 Sargon II, 67
 Sarton, George, 382, 385
 Saudi Arabia, 363
 Scholasticism, 216
 Science, 382–394, *see also* specific disciplines
 Egyptian, 384, 396–405
 European use of Muslim, 388
 major center for study of, 210
 Scientists, 382–394, *see also*, specific

- scientists
 Scot, Michael, 222, 232
 Scotland, 66, 339, 341, 345
 Scott, J. F., 394
 Scott, S. P., 89
 Scythians, 109
 Semitic languages, origin, 101
 Senghor, Leopold Sedar, 397
 Seville, 86
 music and musical instruments, 255
 Sewage systems, 202
 Shakespeare, William, 15, 153, 267–269
 Lucy Negro in sonnets, 344
 scholar, 36
 Shaw, Flora L., 175, 269–270
 Sicily, 56, 202
 Moorish capture, 372
 Silius Italicus, 4, 95
 description of Moors, 114
Sketches of Spain, 281, 320
 Slavery, 4, 12
 Atlantic slave trade, genesis, 357
 effect on Umayyad dynasty, 170
 as an “equal opportunity” institution, 267
 Islamic vs Columbian, 267
 Jewish participation, 168
 miscegenation and, 168, 376
 participation of Franks, 168
 white, 93, 94, 168, 170, 267, 376
 Smallpox, 216
 Smith, Colin, 217
 Smith, David Eugene, 383
 Smith, Grafton Elliot, 94, 102
 Snowden, Frank, 27
 Socrates, 209
 Soil irrigation, 203, 214
Solitary Regime, 216
Some Aspects of the Socio-economic and Cultural History of Muslim Spain: 711–1492, 198
Song fo Roland, 130, 264, 267
 black Saracens in, 43
 Sordo, Enrique, 188
 Spain
 Christian, 200
 compared to medieval Christian Europe, 183
 earliest African invasion, 1
 images of blacks in, 8
 Moors invasion, 2, 161–162
- Spanish Inquisition, 249
 Spinoza, 143
 Steam engine, 384
 Steel, manufacture, 385
The Stolen Legacy, 294
 critique, 11
 Stoll, Elmer E., 36
 Stonehenge, 66
The Story of the Moors in Spain, 89, 337, 355
 Strabo, 111, 127, 209
 Struve, V. V., 396
The Superiority of the Blacks Over the Whites, 37
The Superiority in Glory of the Black Race Over White, 375
 Surgery, 211, 226
 instruments, 218, 223
 Switzerland, 372
- Tacfarinas, 158
 Tacitus, 110, 111, 156
 Taharka, 2
 Talikah, 1
 Tarif, 54
 Tarifa, 54
 Tarik, 85, 333
 African ancestry, 370
 Berber heritage, 370
 conquest of Spain, 54, 161–162, 196
 ethnicity, 161
 Gibraltar as monument to, 372
 protectorate, 371
 Tawny Moors, 25–26, 158
The Teachings of Ptahhotep, 363
 Technology, 383–385
The Tempest, 268
 Thales, 402
 Theodosius, 209, 404
 Thermometer, 384
 Thomas Aquinas, 231
 Thomas, Bertram, 102
 Timbuktu, 283
 Timna, 68
Titus Andronicus, 153, 267, 272
 Toledo, 86
 as center of industry and learning, 255
 Toynbee, Arnold J., 89
 Trigonometry, 221, 388
 Trogodytes, 111, 105, 106, 108, 127
 relationship to Berbers, 126

- Ubada bin Ma-As-Sama, 315
 Ubadah, 8
 Umayyad dynasty, 162, 164
 achievements, 164
 demise, 170
 golden age, 57
 religious tolerance, 12
 University of Naples, 231
 University of Paris, 229, 230
 Uthman' Amr ibn-Bahr al-Jahiz, 37
- Vallicrosa, Jose M. Millas, 207, 229
 Van Sertima, Ivan, 210
 Vandals, 367
 Vinci, Leonardo da, 396
 Visigoths, 159, 370
 Vives, Jaime, 200
- Walata, 283
 Waldseemuller, Martin, 270
 Walladah, 201
 Water wheel, 1, 258, 259
 Webster, Graham, 47
 Wellard, James, 94
 Wells, H. G., 367
 Welsing, Frances Cress, 192
 West Africa, 171
 William the Conqueror, 342
 Williams, Chancellor, 153
 ethnic origins of Moors, 331
 Windmills, 383, 384
 Wine-making, 354
 Winkler, Hans, 125
 Wolof music, 289
 Women
 Berber, 31, 143
 Libyan, 113
*Wonderful Ethiopians of the Ancient
 Cushite Empire*, 158
World's Great Men of Color, 370, 373,
 374
The World's Major Languages, 194
- Xeres, 359
 Ximenes de Cisneros, 13
- Yahia, 87
 Yahya
 conquest of West Africa, 171
 death, 171
 physical description, 194
 Yahya ibn Ali, 307
 Yahya ibn Ibrahim, 171
 Yakub Al-Mansur, 370
 as builder of great cities, 374
 conquests, 374
 physical description, 374
 Ya'kub ibn Yusuf, 8
 Yeboah, Samuel Kennedy, 355
 Yemen, 67
 inhabitants, 187
 Yusef Ali, 15
 Yushkevitch, Adolf P., 382, 386, 388
 Yusuf ibn Tashfin, 61, 87
 African ancestry, documentation, 372
 African features, 194
 conquest of Spain, 87, 175, 373
 death, 372
 founding of Morocco, 173
 leader of Almoravids, 370
 mention in the *Cantigas de Santa
 Maria*, 28
 physical description, 173, 204
- Zaryab, 166, 168
 Zayd bin Harith, 158, 286, 360
 Zenophilus, 47
 Zenta, 158
 Ziryab, 17, 266-267
 accomplishments, 312-314
 as arbiter of taste in Cordoba, 17-18,
 313
 arrival in Spain, 311
 botanical interests, 267
 founder of music conservatory, 266,
 311
 lute, 309, 312
 musicianship, 266, 308
 wealth, 267
 Zoology, 375

They Came Before Columbus

by IVAN VAN SERTIMA

Winner of The 1981 Clarence L. Holte International Prize

"Comprehensive and convincing evidence of links between Africa and America in the Pre-Columbian Period. Ivan Van Sertima takes the subject out of the "Lost Worlds" category and brings together all the known facts established by various disciplines . . . He makes an impressive case for contact . . . A big boost to Black Cultural History."

—Publishers Weekly

"The theory has been argued for years. Usually supported by enthusiasts claiming far too much on very little information. Professor Van Sertima is no such romantic . . . He has pursued it with good judgement and persuasive evidence drawn from a wide variety of sources. A fascinating case worth the attention it demands . . ."

—The Atlantic Monthly

"The majority of Afro-Americans and White Americans accept the slave version as the definitive story of Black presence in this land . . . This book will place Afro-American History in a much more important dimension than *Roots* . . . A remarkable work . . ."

—Los Angeles Sentinel

"This is a pioneering work that will help to bring about a reassessment of the place of African people in world history . . . A scholarly achievement . . . Calls attention to Africa's ages of grandeur and the great adventurous spirit of the Africans that brought them to the worlds beyond their shores . . . After the excitement over Alex Haley's *Roots*, I hope a popular and scholarly reading public will turn to this book where the roots are much deeper . . ."

—John Henrik Clarke, *Africa*

The great stone heads of Mexico are by far the most spectacular evidence that, as civilization was dawning in the New World more than 2,000 years before Columbus, black people from Africa had already reached these shores . . . The leading proponent of an African presence in the New World is Ivan Van Sertima . . . Van Sertima marshals many other kinds of evidence.

—Science Digest (September 1981)

As one who has been immersed in Mexican archeology for some forty years, and who participated in the excavation of the first of the giant heads, I must confess that I for one am thoroughly convinced of the soundness of Van Sertima's conclusions . . .

—Dr. Clarence W. Weiart (Professor of Archeology)
The New York Times Book Review (Letters)

"The French translation of *They Came Before Columbus* has been very well received by the French-speaking intellectual and academic community. Already it is highly regarded as a fundamental contribution by a young Afro-American scholar to universal historical knowledge . . ."

—Dr. Cheikh Anta Diop
 Director, Radio Carbon Laboratory, IFAN University, Dakar, Senegal.

To order a copy, please send \$23.00 plus \$2.50 postage to: Ivan Van Sertima, 347 Felton Avenue, Highland Park, New Jersey 08904. Checks or money orders should be made out to "Ivan Van Sertima."

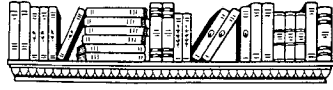

A SERIES OF HISTORICAL CLASSICS

The Journal of African Civilizations, founded in 1979, has gained a reputation for excellence and uniqueness among historical and anthropological journals. It is recognized as a valuable information source for both the layman and student. It has created a different historical perspective within which to view the ancestor of the African-American and the achievement and potential of black people the world over.

It is the only historical journal in the English-speaking world which focuses on the heartland rather than on the periphery of African civilizations. It therefore removes the "primitive" from the center stage it has occupied in Eurocentric histories and anthropologies of the African. The Journal of African Civilizations is dedicated to the celebration of black genius, to a revision of the role of the African in the world's great civilizations, the contribution of Africa to the achievement of man in the arts and sciences. It emphasizes what blacks have given to the world, not what they have lost.



A LISTENER'S LIBRARY OF EDUCATIONAL CLASSICS

Legacies, Inc., the audio arm of the Journal of African Civilizations, was established by Mrs. Jacqueline L. Van Sertima in answer to a genuine need and many requests from parents and teachers across the country. They needed a wide-spread, easily accessible and responsible medium of communication. It had to not only serve as a learning tool, but as an informational vehicle for educational strategies that hold promise for our youths. They also needed a dynamic and expedient way to absorb and disseminate information as well as a bridge to parents whose time for relearning and participation in the educational process was limited. So, in keeping with the highly controversial needs of the times, Legacies, Inc. was born.

In most of our audio cassette tapes, you will be hearing the voice of Dr. Ivan Van Sertima. His untiring fervor has made learning for everyone an exciting adventure through time. All lectures, by a variety of speakers, are brilliant, stimulating, passionate and absorbing. It is the drama of forgotten peoples and civilizations, brought to you through an unusually fresh and liberating vision of the human legacy.

AUDIO TAPES

African Presence in Early America & Address to the Smithsonian	\$10.00
African Presence in Early Asia - R. Rashidi & Van Sertima	\$10.00
African Presence in Early Europe	\$10.00
African Presence in World Cultures	\$10.00
The Black Family - J.H. Clarke & Van Sertima	\$10.00
Black Women in Antiquity	\$10.00
Blacks in Science: ancient and modern	\$10.00
Egypt Revisited	\$10.00
Golden Age of the Moor - R. Rashidi & Van Sertima	\$10.00
Great African Thinkers - C.A. Diop	\$10.00
Great Black Leaders: ancient and modern	\$10.00
The Legacy of Columbus - Jan Carew	\$10.00
Re-Educating Our Children	\$10.00
Socialization of the African-American Child - Asa G. Hilliard	\$10.00
They Came Before Columbus	\$10.00
Van Sertima Before Congress	\$10.00

Bookmarks are laminated, 2 1/2" x 8 1/4", color and black & white with gold or silver metallic tassels. Specify 2 bookcovers and designate placement. All bookmarks are \$3.00 each. + .39 postage.

BOOKMARK(S): Top

Bottom

Name _____ Date _____
 Address _____
 City/State _____ Tel. No. _____
 Zip _____

Check and money orders should be made payable to:

"Legacies"
 Jacqueline L. Patten-Van Sertima
 347 Felton Ave.
 Highland Park, New Jersey 08904

Please include postage:

1 tape75
 2 tapes 1.44
 3 tapes 1.90
 4-10 tapes 2.90
 11-16 tapes 4.10

Please Note:
 Tapes cannot be purchased through
 bookstores or other vendors.

BOOKS

African Presence in Early America	\$15.00
African Presence in Early Asia (out of print)	\$15.00
African Presence in Early Europe (August)	\$15.00
Black Women in Antiquity	\$20.00
Blacks in Science: ancient and modern	\$20.00
Egypt Revisited (August)	\$20.00
Egypt: Child of Africa (November) New!	\$20.00
Golden Age of the Moor	\$20.00
Great African Thinkers - C.A. Diop	\$15.00
Great Black Leaders: ancient and modern	\$20.00
Nile Valley Civilizations (cancelled)	\$20.00

Postage for above books:

\$1.50 per order of single book.

\$.50 more for each additional book

They Came Before Columbus

\$23.00

postage \$ 2.50

(For this particular book, please make checks payable to

"Ivan Van Sertima".)

← Don't forget to order your matching bookmarks!

Add \$7.50 per book
 foreign airmail.

Name _____ Date _____
 Address _____
 City/State _____ Tel. No. _____
 Zip _____

Check and money orders should be made payable to:

"Journal of African Civilizations"
 Ivan Van Sertima (Editor)
 Journal of African Civilizations
 African Studies Department
 Beck Hall
 Rutgers University
 New Brunswick, New Jersey 08903